



**SADIQ SURGICAL CO.**

**Catalogue 2015 / 2016**



**Plastic Surgery Instruments**



**SADIQ SURGICAL CO.**

Catalogue 2015 / 2016

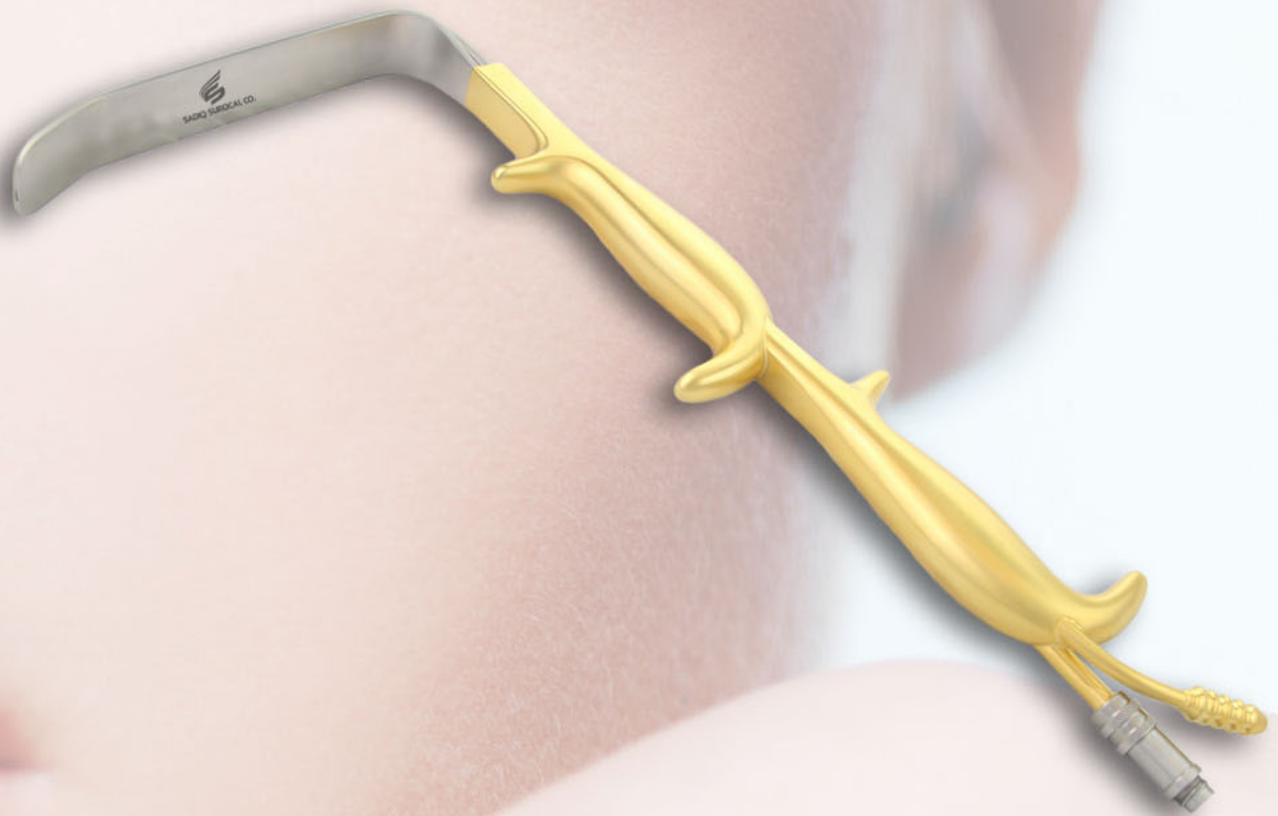

**Plastic Surgery Catalogue**

**Plastische Chirurgie Katalog**

**Catalogue Chirurgie Plastique**

**Catalogo Cirugía Plástica**

**Catalogo Chirurgia Plastica**



**SADIQ SURGICAL CO.**

**Company Name: Sadiq Surgical**

**Address: Ugoki Road, New Adalat Garah, Street Number: 01**

**Bhutta Chock, Sialkot 51310 PK**

**Mobile Phone: 0092 346 6629614**

**Mobile Phone: 0092 301 3075058**

**Email: info@sadiqsurgical.com**

**Email: sadiqsurgical@gmail.com**

**Website: www.sadiqsurgical.com**

# Table of Contents

Inhaltsverzeichnis  
Tavola dei contenuti  
Tabla de contenido  
Table des matières

<b>Sadiq surgical</b>	Firmenprofil <b>Company Profile</b> Profilo Compagnia Perfil de la empresa Profil de l'entreprise	<b>III</b>		<b>9</b>	Nasenraspeln, Löffel Nasal Rasps, Curettes Raspe nasali, Cucchiari Raspadores nasales, Cuccharillas Râpes nasales, Curettes
<b>Sadiq surgical</b>	Technische Informationen - Sterilisierung <b>Technical Information - Sterilization</b> Informazioni tecniche - Sterilizzazione Información técnica - Esterilización Information technique - Stérilisation	<b>V</b>		<b>10</b>	Hohlmeisselzange <b>Rongeurs</b> Pinze ossivore Pinzas Gubias Pincas Gouges
<b>1</b>	Diagnostik, Meßinstrumente, Skalpelle <b>Diagnostic, Measuring Instruments, Knives</b> Diagnostica, Strumenti per misura, Bisturi Diagnostico, Instrumentos de medición, Bisturíes Diagnostic, Instruments à mesurer, Bistouris	<b>1</b>		<b>11</b>	Absaugkanülen, Nagelzangen <b>Suction tubes, Nail Nippers</b> Cannule, Tronchesi per unghie Cánulas, Pinzas para uñas Canule, Pincas pour ongles
<b>2</b>	Scheren <b>Scissors</b> Forbici Tijeras Ciseaux	<b>13</b>		<b>12</b>	Wartung und Sterilisierung <b>Maintenance and Sterilization</b> Manutenzione e Sterilizzazione Mantenimiento y Esterilización Entretien et Stérilisation
<b>3</b>	Pinzetten <b>Tissue Forceps</b> Pinzette Pinzas Pincas	<b>77</b>		<b>13</b>	Alphabetischen Index <b>Alphabetical index</b> Indice alfabetico Indice alfabético Index alphabétique
<b>4</b>	Arterienklemmen, Drahtumführungsnadel <b>Hemostatic Forceps, Wire Guides</b> Pinze emostatiche, Passafili Pinzas hemostáticas, Agujas para ligaduras Pincas hémostatiques, Cerclage instruments	<b>107</b>		<b>14</b>	Alphanumerischen Index <b>Alphanumerical index</b> Indice alfanumerico Indice alfanumérico Index alphanumérique
<b>5</b>	Nadelhalter <b>Needle Holders</b> Port'aghi Portaagujas Porte aiguilles	<b>131</b>		<b>15</b>	Addendum - Plastische Chirurgie <b>Addendum - Plastic Surgery</b> Addendum - Chirurgia Plastica Addendum - Cirugía Plástica Addendum - Chirurgie Plastique
<b>6</b>	Mundsperrer, Wundhaken, Nasen Spekula <b>Mouth gags, Retractors, Nasal Specula</b> Apribocca, Divaricatori, Speculum nasali Aprebocas, Separadores, Espéculos nasales Ecarteur buccal, Ecarteurs, Spéculums nasaux	<b>163</b>		<b>16</b>	Addendum - Nummernverzeichnis <b>Addendum - Alphanumerical index</b> Addendum - Indice alfanumerico Addendum - Indice alfanumérico Addendum - Index alphanumérique
<b>7</b>	Raspatorien, Elevatorien <b>Raspatories, Elevators</b> Periostotomi, Elevatori Legras, Elevadores Rugines, Elevateurs	<b>203</b>		<b>17</b>	Service und Reparatur <b>Service and Repair</b> Servizio e Riparazione Servicio y Reparación Service et Réparation
<b>8</b>	Knochenmeissel, Hämmer Bone Chisels, Hammers Scalpelli, Martelli Cinceles, Martillos Scalpel, Maillets	<b>221</b>		<b>18</b>	Vergleichstabellen <b>Conversion Tables</b> Tabelle di comparazione Tablas de comparación Tableaux de comparaison

## Company Profile

### Sadiq Surgical | Chirurgische Instrumente

#### Unsere Mission

Eine globale Präsentation als führender Designer und Hersteller von qualitativ hochwertigen chirurgischen Handinstrumenten im Bereich der Dental und Medizin-chirurgie aufzubauen. Unser Ziel wird mit dem Angebot von herausragenden Produkten und Dienstleistungen angestrebt die mit Engagement die Erwartungen unserer Kunden übertreffen.

#### Über Uns

**Sadiq Surgical CO.** (mit Sitz in Tuttlingen, Deutschland) entwirft, produziert und vermarktet chirurgische Instrumente für den Dental und Medizinisch-Chirurgischen Bereich mit einer umfassenden Produktpalette von mehr als 10000 Instrumente.

Seit Jahrzehnten hat Sadiq Surgical Co. auf dem europäischen Markt seine Anerkennung als Spitzenprodukt bestätigt. Sadiq Surgical Co. hat sich in den letzten Jahren auch auf dem Nordamerikanischen Markt durchgesetzt und wird weiterhin als ausgezeichnete Qualität anerkannt.

#### Was unterscheidet uns? Herausragende Qualität!

Sadiq Surgical stellt chirurgische Instrumente aus rostfreiem martensitischen Stählen her (AISI 421, 440, 440C2) - derzeit der führende rostfreie Stahl auf dem Markt erhältlich! Die Stärke unserer Marke basiert auf herausragender Qualität und Service, sowie einer unübertroffenen Garantie von 5 Jahren auf Fabrikationsmängel!

#### Beteiligung der Industrie

Als ein führender globaler Anbieter von chirurgischen Instrumenten verfügt Sadiq Surgical Co. über bedeutende Händler in Europa, Nord und Südamerika, im Mittleren Osten und in Asien die unsere Produkte an praktizierenden Chirurgen anbieten. Sadiq Surgical Co. beibehält seine innovative Führungsrolle durch die enge Zusammenarbeit mit Händlern und praktizierenden Chirurgen, aus denen neue Produkte hervorgehen. Durch die Teilnahme und das Angebot an Seminaren und Schulungen die über die richtige Auswahl, Benutzung und Pflege von Instrumenten informieren, ist Sadiq Surgical Co. immer ein Schritt voraus in hinsicht auf Produktaufklärung. BMT wird sich weiterhin als ein führendes Medizintechnisches Unternehmen durch die Teilnahme und Unterstützung an Führungskongressen auf weltweiter Ebene weiterbilden.

#### Produkt- und Qualitätszertifizierungen

Sadiq Surgical Co. -Produkte sind registriert und erfüllen die Regelungen der Europäischen Gemeinschaft (EG), der US Food and Drug Administration (FDA), Health Canada und der Koreanischen Food and Drug Administration (KFDA).

### Sadiq Surgical | Surgical Instruments

#### Our Mission

Establish a global presence as a leading designer and manufacturer of high quality handheld surgical instruments in the dental and medical surgical fields. Our goal will be achieved through the offering of excellent products and services; and by our commitment to exceed customer expectations.

#### About Us

**Sadiq Surgical CO.** (located in Tuttlingen, Germany) designs, manufactures and markets a complete product portfolio of over 10,000 surgical instruments to the dental and medical markets.

For decades, our brand has gained recognition in the European marketplace as a high quality premier brand, and, in recent years, has made its mark into the North American marketplace where it continues to be recognized for its exceptional quality.

#### What makes us different? Outstanding quality!

Sadiq Surgical instruments from martensitic stainless steels (AISI 421, 440, 440C2) which is the highest quality stainless steel available. Our brand is built on outstanding product quality, service and an unsurpassed warranty of 5 years against manufacturing defects!

#### Industry Participation

As a leading global provider of surgical instruments, Sadiq Surgical Co. has major distributors located throughout Europe, the Americas, the Middle East and Asia. Sadiq Surgical Co. maintains its leadership in innovation by working closely with its distributors and surgical practitioners to develop new products. Sadiq Surgical Co. is also in the forefront of product education by offering and participating in seminars and other educational events on proper instrument selection, usage and care. Sadiq Surgical Co. continues to establish itself as a premier surgical instrument company by attending

#### Product and Quality Certifications

Sadiq Surgical Co. products are registered and comply with European Conformity (CE), U.S. Food and Drug Administration (FDA), Health Canada, and Korean Food and Drug Administration (KFDA).



## Company Profile

### Sadiq Surgical Co. | Strumenti Chirurgici

#### La Nostra Missione

Stabilire una presenza globale come leader nella progettazione e produzione di strumenti chirurgici di alta qualità nei settori dentale e medico.

Raggiungeremo il nostro obiettivo offrendo prodotti e servizi eccellenti. Il nostro impegno principale sarà superare le aspettative dei Clienti.

#### Chi Siamo

**Sadiq Surgical Co.** (con sede a Tuttlingen, Germania) progetta, produce e commercializza un catalogo completo di 10.000 strumenti per i mercati dentale e medico chirurgico.

Per decenni, il nostro marchio ha ottenuto nei mercati europei il riconoscimento quale sinonimo di Strumentario di alta qualità. Negli ultimi anni, ha allargato la propria distribuzione al mercato nordamericano, dove ha confermato le proprie straordinarie caratteristiche.

#### Cosa ci rende diversi? Eccezionale qualità!

Sadiq Surgical Co. produce Strumenti chirurgici con acciai inossidabili martensitici (AISI1 421, 440, 440C2): la migliore qualità di acciaio inox disponibile.

Il nostro marchio ha costruito la propria leadership sulla eccellente qualità del prodotto, un servizio unico ed una garanzia di 5 anni contro qualsiasi difetto di fabbricazione.

#### Presenza mondiale

In qualità di fornitore mondiale di strumenti chirurgici, Sadiq Surgical Co. ha rapporti di collaborazione con i maggiori Distributori presenti in Europa, Americhe, Medio Oriente e Asia. Sadiq Surgical Co. mantiene la sua leadership nell'innovazione lavorando a stretto contatto con i propri Distributori e Operatori chirurgici per sviluppare nuovi prodotti.

Sadiq Surgical Co. fornisce anche formazione sul prodotto, offrendo e partecipando a seminari ed altri eventi educativi nei quali vengano consigliate indicazioni complete sulla corretta selezione degli strumenti, l'uso e la cura. Sadiq Surgical Co. partecipa e sostiene importanti conferenze ed eventi culturali in tutto il mondo.

#### Certificazioni di qualità

Tutti i prodotti Sadiq Surgical Co. sono marchiati CE; approvati dalla US Food and Drug Administration (FDA); dalla Health Canadese; dalla Food and Drug Administration coreana (KFDA).

### Sadiq Surgical Co. | Instrumentos Quirúrgicos

#### Nuestra Misión

Establecer una presencia global como diseñador y fabricante líder de instrumentos quirúrgicos de alta calidad para las distintas especialidades médicas y dentales.

Nuestro objetivo es ofrecer excelencia en todos nuestros productos y servicios, sumado a nuestro compromiso de superar las expectativas de los clientes.

#### Quiénes somos

**Sadiq Surgical Co.** (con sede en Tuttlingen, Alemania) diseña, fabrica y comercializa una amplia gama de productos, con más de 10.000 instrumentos destinados a los mercados quirúrgicos y dentales.

Nuestra marca ha ganado el reconocimiento en el mercado europeo como un sinónimo de instrumentos de primera calidad alta. En los últimos años, ha ampliado su distribución en el mercado norteamericano, donde ha confirmado su calidad excepcional.

#### ¿Qué nos hace diferentes? Excelente calidad!

Sadiq Surgical Co. fabrica instrumentos quirúrgicos con acero inoxidable martensítico (AISI1 421, 440, 440C2), la más alta calidad de acero inoxidable disponible.

Nuestra marca se basa en la fabricación de productos de primera calidad, un servicio único y una garantía sin igual de 5 años contra defectos de fabricación.

#### Presencia mundial

Como proveedor mundial de instrumentos quirúrgicos, Sadiq Surgical Co. tiene alianzas con los principales distribuidores en Europa, América, Oriente Medio y Asia. Sadiq Surgical Co. mantiene su liderazgo en la innovación, trabajando estrechamente con sus distribuidores y los profesionales médicos para desarrollar nuevos productos.

Sadiq Surgical Co. está a la vanguardia de la formación continua, dictando cursos y seminarios sobre la selección adecuada de instrumentos, uso correcto y mantenimiento. Sadiq Surgical Co. se consolida como una empresa de primera línea en el sector de instrumental quirúrgico de alta calidad, participando y apoyando los más importantes eventos profesionales a través del mundo.

#### Certificaciones de calidad

Todos los productos Sadiq Surgical Co. están registrados y cumplen con la Conformidad Europea (CE), U.S. Food and Drug Administration (FDA), Health Canada y Korean Food and Drug Administration (KFDA).

### Sadiq Surgical Co. | Instruments Chirurgicaux

#### Notre mission

Établir une présence globale comme leaders en design et en manufacture d'instruments chirurgicaux tenus à la main Dans les domaines de la chirurgie dentaire et médicale.

Cet objectif continuera d'être atteint par l'offre de produits et services d'excellente qualité ainsi que par notre engagement de dépasser les attentes de nos clients.

#### À propos de nous

**Sadiq Surgical Co.** (située à Tuttlingen, Allemagne) conçoit, fabrique et met en marché un portefeuille complet comportant plus de 10,000 instruments destinés aux marchés de produits dentaires et chirurgicaux.

Depuis plusieurs dizaines d'années, notre marque a su accroître sa réputation dans le marché Européen en tant que première marque de très haute qualité et, plus récemment, elle se démarque sur le marché Nord-Américain où elle continue d'être reconnue pour sa qualité exceptionnelle.

#### Ce qui nous distingue? La qualité nettement supérieure!

Sadiq Surgical Co. fabrique ses instruments de chirurgie à partir d'aciers inoxydables martensitiques (AISI1 421, 440, 440C2), ce qui correspond à la qualité maximale pour l'acier inoxydable. Notre marque s'est construite grâce à une qualité de produits exceptionnelle, son service et une garantie sans pareil de 5 ans contre les défauts de fabrication!

#### Participation dans le marché

En tant que chef de file en tant que fournisseur global d'instruments chirurgicaux, Sadiq Surgical Co. a des distributeurs majeurs situés à travers l'Europe, les Amériques, le Moyen-Orient et l'Asie. Sadiq Surgical Co. maintient son leadership en innovation en travaillant de très près avec ses distributeurs et praticiens et chirurgiens dans l'élaboration de nouveaux produits.

Sadiq Surgical Co. est aussi à l'avant-garde de l'éducation sur les produits en offrant et en collaborant à des séminaires et autres événements éducatifs qui traitent des bonnes pratiques dans la sélection, l'utilisation et le soin des instruments. Sadiq Surgical Co. continue à s'établir en tant que chef de file en étant présent et en appuyant les conférences majeures à travers le monde.

#### Certifications de produits et de qualité

Les produits Sadiq Surgical Co. sont enregistrés et sont conformes aux normes du European Conformity (CE), du U.S. Food and Drug Administration (FDA), de Santé Canada, et du Korean Food and Drug Administration (KFDA).

## Technical Information

### About Sadiq Surgical co.

All Sadiq Surgical Co. instruments are hand crafted in Germany from grade 440 Rockwell surgical steel, in order to exceed surgeon specifications for ergonomics and duration. Stainless steel is mainly used for the production of all instruments that do not require sharpening, while carbon steel, a special alloy, retains characteristics that are more suitable for cut and less for corrosion. Due to the high quality of our surgical products, Sadiq Surgical Co. is proud to offer a five-year guarantee covering all manufacturing defects.

Each Sadiq Surgical Co. instrument is produced and controlled with the utmost care and destined exclusively for professionals and for the use which they have been devised and realized. In order to ensure proper use of our instruments, we suggest you read the following instructions to ensure their maximum efficiency and duration.

### First Use

The instrument is supplied in a "non sterile" and imbued with a special liquid oily in cycles, parts and pivoting in those screwed.

Therefore, before use, you must good wash the instruments using neutral detergent and/or degreasers suitable for steel, so as not to cause unpleasant complications with the instrument (red spots, induration pivoting shares, etc.).

Before being sent to destination, all our instruments are inspected, lubricated, and individually packed. It is necessary to wash and cleanse each instrument carefully prior to each usage. After having used the instruments, brush off any excess particles using nylon bristles (never use steel bristles) and rinse them individually.

In the event of a potentially infected instrument, soak the instrument in a disinfectant detergent solution for at least 10 minutes. Cleaning in an ultrasound basin is not recommended for instruments with cutting edges (scissors, bistouries, bone forceps, scalpels, etc.) and instruments with tungsten carbide insertions (TC). They may chip, break or corrode. Cutting instruments of different materials (chromate, copper, aluminium, titanium and stainless steel) should always be cleaned and stored separately.

After the cleaning, make sure that all the instruments are perfectly dry. We recommend re-lubricating the instruments with surgically approved products only. Never use industrial oils or lubricants.

After having cleaned, rinsed and lubricated the instruments the sterilizing phase can start.

### Martensitic steel instruments

All Sadiq Surgical Co. instruments are made up of high quality martensitic stainless steel, also known as surgical steel. Nevertheless, in case of exposure to the action of some particular chemical substances, or should these substances be used in wrong doses or exposures not be observed, instruments might be subject to loss of polish, corrosion or even to an alteration of their superficial physical properties. Surgical steel instruments shouldn't be exposed to the prolonged action of chloride solutions. Moreover, instruments should never be exposed to the action of or kept in prolonged contact with chlorine solutions, hypochlorites, ferric chloride, hydrochloric acid and iodine.

### Tungsten carbide inserts

By using these special materials during tempering high HRC hardness degrees can be obtained, which allows achieving perfect grinding and extraordinary life of instruments. When compared with steel instruments, tungsten carbide (TC) instruments are more sensitive to chemicals and therefore require special care. TC instruments should never be exposed to any of the above mentioned chemical substances, nor to any other corrosive chemical.

In order to ensure perfect maintenance of TC instruments, you are recommended to follow three simple but important rules:

- Use solutions containing corrosion inhibitor for cleaning and sterilization.
- Do not use ultrasound devices for cleaning, as they might take off or splinter the TC insert.
- After cleaning, dry the instruments thoroughly before submitting them to sterilization.

### Joint and hinge instruments

Joint and hinge instruments should always be sterilized in open position. All joint and hinge instruments should always be kept well lubricated.

Regular use of Rodhoil (DB-OLR) high density lubricant and Cleanlact (DB-1L) concentrated anticorrosive-bacteriostatic detergent, will prevent rust, corrosion and stiff joints and will ensure smooth operation.

---

# Rinsing Procedures

---

## Rinse

Immediately after surgery, rinse instruments under warm (not hot) running water. Rinsing should remove all blood, body fluids and tissue. Dried soils may damage the instrument surface and make cleaning very difficult. Do not use hot water as this will coagulate proteinous substances.

After rinsing, you can start any of the three cleaning techniques\*.

*(\* If not done immediately after rinsing, instruments should be submerged in a solution of water and neutral PH(7) detergent - "only" PH(7) because if not rinsed off properly, low PH detergents will cause breakdown of stainless protective surface and black staining. High PH detergent will cause surface deposit of brown stain, which will also interfere with smooth operation of the instrument. We strongly recommend using a detergent containing a rust inhibitor.*

---

# Cleaning Procedures

---

## Ultrasonic Cleaning

Using ultrasound combined with a special cleaning solution, **it is the most effective cleaning method available.**

Recommended for regular instruments such as hand instruments and forceps. Ultrasonic cleaning *is not recommended for instruments which are very delicate, are not 100% steel or which have sharp cutting edges* (scissors, needle holders, bone forceps and not 100% steel such as rubber, mouth mirrors, titanium, tungsten carbide inserts - TC or diamond dusted tips, etc.). The ultrasonic vibrations can chip, break or corrode any welded parts. For the delicate instruments, use manual cleaning.

*Steps to follow:*

- 1) Sort instruments carefully so as to include only instruments compatible with ultrasonic cleaning.
- 2) Place instruments in open position.
- 3) Make certain sharp edges are not touching other instruments.
- 4) Do not combine different metals (chrome plated, stainless, copper, titanium, etc.)
- 5) Change solution frequently to avoid accumulation of micro organisms.
- 6) After rinsing and before sterilization, inspect and dry the instruments thoroughly.

*Advantages*

• Safer than hand scrubbing, cleans instruments very effectively, reduces the risk of contaminants spreading through splatter, allows for more efficient use of staff time.

*Disadvantages*

- Remember to sort the instruments carefully and to change the cleaning solution.
- If the cement is not removed while it is still soft, ultrasonic cleaning will not remove hardened permanent cement.

## Manual Cleaning

We recommend ultrasonic cleaning as the best and most effective way to clean surgical instruments, but sharp or delicate or not 100% steel instruments should be cleaned manually.

*Steps to follow:*

- 1) Use stiff plastic cleaning brushes (DB-11, DB-12, nylon, tooth brush, etc.) Do not use steel wool or wire brushes except specially recommended stainless steel wire brushes for instruments such as bone files, or on stained areas in knurled handles. In this case always treat instruments with the special "cleaning milk" Cleanlact so as to restore and protect the anti-rust coating.
- 2) Brush delicate instruments carefully and, if possible, handle them separately from general instruments.
- 3) Make sure all instrument surfaces are visibly clean and free from stains and tissue.
- 4) After scrubbing, rinse instruments thoroughly under running water. While rinsing, open and close scissors, hemostats, needle holders and other hinged instruments to ensure the hinge areas are fully rinsed, inside and out.

*Advantages*

• Effective if performed properly.

*Disadvantages*

- Increases risk of operator injury, increases the risk of contaminants spreading through splatter, labor-intensive.
- Requires proper care and periodical replacement of scrub brushes.

## Automated Washer

This can also be a very effective cleaning method. Not all instruments are compatible with automated washers and restrictions vary according to the washer model.

*Steps to follow:*

It is necessary to see manufacturer's instructions for detailed requirements.

*Advantages*

- Same as Ultrasound Cleaning

*Disadvantages*

- Same as Ultrasound Cleaning.





---

# Lubricating Procedures

## Lubrication

Immediately after surgery, rinse instruments under warm (not hot) running water. Rinsing should remove all blood, body fluids and tissue. Dried soils may damage the instrument surface and make cleaning very difficult. Do not use hot water as this will coagulate proteinous substances.

*Always* lubricate instruments before sterilization, immediately after the last rinse cycle. Lubricate all instruments which have any metal to metal action such as hemostats, scissors, retractors and needle holders using the Rodhoil (DB-OLR) high density lubricant.

Proper lubrication will make your instruments more resistant to corrosion, rusting and staining. In addition to corrosion and stain prevention, lubrication cuts down friction at the joints, keeping the action of the instrument smooth, delicate and light and extending the life of your instruments.

We also recommend the Cleanlact (DB-1L) solution which is very effective in maintaining the anti-rust finish of your instruments and which also acts as a lubricant (see our further section stain treatment).

---

# Sharpening Procedures

## Why sharpen instruments?

Surgical Instruments should be kept identical to their original design. Dental and surgical procedures are most effective when using sharp instruments as they reduce hand and wrist fatigue, improve calculus removal, save time, improve tactile sensitivity, and minimize patient discomfort.

Instruments can be sharpened by using different types of stones:

**Arkansas** (a natural stone extracted from the mountains of Arkansas) and **India** (a synthetic stone quarried from the finest Ozark novaculite deposits -silicon quartz).

• *Arkansas flat stone* (DB-96)

Used to sharpen all cutting parts of surgical instruments (edge and toe of an instrument)

• *Arkansas conical stone* (DB-299)

Used to manually sharpen internal parts of curettes, scalers, gouges, rongeurs, etc. (toe and face of an instrument).

• *Arkansas rectangular stone* (DB-4)

Used to sharpen all cutting parts of surgical instruments (toe and face of an instrument).

• *Arkansas wedge stone* (DB-6A)

Used to manually sharpen internal parts of curettes and scalers. (toe and face of an instrument). Routine sharpening and finishing.

• *India wedge stone* (DB-3)

Used for sharpening of excessively dull instruments or those requiring re-contouring (toes and faces of an instrument).

## How to sharpen instruments?

Generally, the instruments should be sharpened following this procedure:

- 1) Place one drop of Sharpenoil (DB-OL) on the arkansas/india stone. Lubrication improves the movement of the instrument blade over the stone; also, it prevents the metal particles from clogging the stone.
- 2) Hold the instrument in one hand, while applying the stone to the lateral surface angled with the face of the blade.
- 3) Position the stone to contact the heel of the blade and work toward the tip, keeping the stone in contact with the blade throughout the sharpening procedure.
- 4) Move the stone up and down with short strokes, placing more pressure on the down stroke. (Do not move the instrument, keep the instrument still).
- 5) Finish sharpening the instrument with a down stroke; this will prevent a rough edge from forming.
- 6) Evaluate the sharpness with the teflon testing stick (DB-15). If the blade is still dull, re-evaluate the angle of the stone and repeat the sharpening procedure (steps 2-6)

### Scalers and Curettes

• *Sickle Scaler Toe End*

The sickle scaler has a pointed tip and, therefore, the stone is held straight as it nears the tip.

• *Curette Toe End*

The curette has a rounded toe, so the position of the stone is adapted around the rounded cross-section. With both types of instrument, always finish on a down stroke to remove any flash of metal.

## When to sharpen instruments?

Instruments should be sharpened lightly after each use; there are two ways to evaluate whether the cutting edge is dull and requires sharpening:

• *Visual*

The cutting edge should be inspected regularly in a good light (and if possible, under magnification). If the cutting edge is blunt it will be rounded and reflect the light. A dull, non-reflective line indicates sharpness.

• *Teflon Testing Stick* (DB-15)

If the blade of the instrument runs smoothly over the testing stick, then it is blunt. A sharp instrument will grab into the stick and removes small fragments of the plastic.

### Care of Sharpening Stones

After use, wipe the stone with a clean cloth to remove metal particles. Then, clean the stone by scrubbing or using ultrasound to remove lubricant before sterilization. After sterilization, lubricate before each use. Be sure to use entire stone to prevent "grooving".

---

# Sterilization Procedures

---

## Inspection

Before preparing for sterilization, all instruments should be inspected. Generally un-magnified visual inspection under good light conditions is sufficient. All parts of the instruments should be checked for visible soil and/or corrosion.

*Remember: some types of damages (corrosion, rust and spots) are transmitted to the instruments intact. Always check cutting edges for sharpness and damage.*

## Packaging

Where appropriate the cleaned, disinfected, and checked medical devices should be assembled into the dedicated trays provided. Sadiq Surgical Co. cassettes/containers should be simple or double wrapped according to AAMI/CSR technique. (AAMI: Association for Advancement of Medical Instrumentation / CSR: central sterilization room)

The packaging for terminally sterilized medical devices should fulfill the following requirements:

- EN ISO 11607
- Suitable for steam sterilization (temperature resistance up to at least 141 °C, sufficient steam permeability)
- Sufficient protection of the instruments as well as of the sterilization packagings to mechanical damage.

## Sterilization

It is a procedure which removes all pathogenic and non pathogenic micro-organisms; it should be performed with utmost care.

These are the most common and effective sterilization techniques:

- 1 | Autoclave - Steam Sterilization
- 2 | Chemiclave
- 3 | Dry Sterilization

---

# Sterilization Techniques

---

## Autoclave - Steam Sterilization

Steam autoclave (moist heat) sterilization using a pre-vacuum (forced air removal) cycle is recommended. Instruments are treated with high pressure water steam.

Sterilizing agent: distilled water.

Recommended standard times and temperature\*:  
4 - 20 min. / 130 - 134°C (266 - 268°F)

### Advantages

- Highly effective
- Nontoxic
- Inexpensive
- Rapid heating & rapid penetration of instruments

### Disadvantages

- Items must be heat and moisture resistant.
- Needs good maintenance. The autoclave is not working correctly if steam comes out of the lid or around the door.

## Chemiclave

Instruments are treated with high pressure, with the help of chemical steams. Instruments must be dried before sterilization.

Sterilizing agent: special chemical solutions.

Recommended standard times and temperature\*:  
4 - 20 min. / 130 - 134°C (266 - 268°F)

### Advantages:

- Minimal dulling, rusting and corroding of instruments.
- Unsaturated chemical vapor method is a low-humidity process.
- The heat-up time is shorter than for most steam sterilizers.
- Easy to operate, fill and purge / Minimal order.

### Disadvantages:

- Needs adequate ventilation / It is flammable
- Vapo-Steril solution has formaldehyde in it, known to be a potential carcinogen.
- Needs to be mixed with water when disposed.

## Automated Washer

Instruments sterilization takes place by means of hot air. Instruments must be dried before sterilization.

At present, this sterilization technique is not recommended, as it doesn't guarantee reliable sterilization and gradually causes damages.

Recommended standard times and temperature\*:  
60 - 90 min. / 150 - 170°C (300 - 320°F)

### Advantages

- Reaches surfaces of instruments that cannot be disassembled. This is accomplished by conduction.
- Low cost.

### Disadvantages

- Long exposure time is necessary.
- High temperatures gradually cause damages such as surface blackening, loss of polish and dullness.
- Specialized packaging is needed.

For more information, view our catalogue online:  
**"Instrument Cleaning, Sterilization & Maintenance"**  
[www.sadiqsurgical.com](http://www.sadiqsurgical.com)

# Instrument Protection

## Instrument Care

Surgical instruments can be reused, unless indicated otherwise. The life time of instruments depends on the frequency of use, the care of the user and proper reprocessing methods. The most effective method of dealing with instrument problems is to prevent them from occurring. The use of "treated water", careful preliminary cleaning, the use of neutralized PH solution, adherence to manufacture's instructions, and visual inspection, will help to keep instruments performing accurately free of troublesome stains. It is important to act quickly should a problem arise.

## New Instruments

- New instruments must be processed before use.
- They must undergo the entire cleaning process.
- They are usually oiled in production and this must be removed prior to running them through a sterilizer (Do not take from packaging and go to the sterilizer).

## Factors affecting instrument care

### 1 | Water

Regular tap water is not appropriate for instrument sterilization. High chloride and lime concentration and various other minerals can lead to staining or damage of the stainless steel. When water dries, chlorides will concentrate and cause pitting on the instrument. Fully Desalted Water avoids this problem.

### 2 | Corrosion

Certain compounds are highly corrosive to stainless steel and will cause serious damage despite the passivated protective surface. If instruments are inadvertently exposed to any of the following substances, they should be rinsed immediately with copious amounts of water.

Instruments should never be exposed to:

- Aqua regia
- Ferric chloride
- Hydrochloric acid
- Iodine
- Sulfuric acid

## Removing Stains

Stains can be removed, whereas rust will leave permanent damage. To determine if a brown or orange discoloration is a stain or rust, use the eraser test:

- 1) Rub a pencil eraser over the discoloration.
- 2) If the discoloration is removed with the eraser and the metal underneath is smooth and clean, this is a stain.
- 3) If a pit mark appears under the discoloration, this is corrosion or rust.

## Stain and Rust Protection

It is common for instruments to become stained or spotted despite the best efforts. In nearly all cases these problems are the result of minerals deposited upon the surfaces of the instruments, as well as insufficient cleaning. Proper technique during cleaning and sterilizing procedures will prevent most staining occurrences.

### Diagnosing spots and stains

#### • Brown/Orange Stains

Cause: A result of high-pH detergents. Chlorhexidine usage or improper soaking of instruments. This color stain can also be caused by soaking in tap water.

#### • Dark Brown Stains

Cause: Low-pH instrument solutions. The brownish-colored film may also be caused by a malfunctioning sterilizer. Similar localized stain spots can also be a result of baked-on blood.

#### • Bluish Black Stains

Cause: Reverse plating, when instruments of different metal (e.g. chrome and stainless steel) are ultrasonically processed together. This can occur when high quality instruments are mixed with lower end ones. Additionally, exposure to saline, blood, or potassium chloride will cause this bluish black color. Similar to tarnish on silverware.

#### • Black Stains

Cause: Contact with ammonia or a solution containing ammonia.

#### • Light or Dark Spots

Cause: Water droplets drying on the instruments. With slow evaporation, the minerals sodium, calcium and magnesium left behind can cause this spotting.

#### • Rust Deposits

Cause: Dried blood that has become baked on the serrated or hinged areas of surgical instruments. This organic material, once baked on, may appear dark in color. Also can be caused by soaking in tap water.

# Warnings

- Sadiq Surgical Co. product warranty against manufacturer defects automatically expires in the cases of improper care, maintenance and/or use.
- New instruments must undergo the entire cleaning process before use. Do not take from packaging and go to the sterilizer.
- Avoid putting oxidized or rusty instruments in sterilizing or disinfectant solutions, as other instruments could be attacked.

- Sadiq Surgical Co. usually does not define the maximum number of uses appropriate for re-usable surgical instruments. The useful life of these devices depends on many factors including the method and duration of each use, and the handling between uses. Careful inspection and functional test of the device before use is the best method of determining the end of serviceable life for the medical device.

- Used, damaged and oxidized tools should not be used because they are no longer able to perform their function. Please note that some types of damages (corrosion, rust and spots) are transmitted to the instruments intact.
- Sterilization does not replace the cleaning and maintaining of the instruments. •Ultrasonic Cleaning does not sterilize.
- The tools provided by Sadiq surgical are subject to Directive 93/42/EEC and therefore be discarded by the regional force.

# Instrument Maintenance and Sterilization

Remove gross soil / Place in aldehyde-free disinfectant bath / Rinse in running water / Disassemble where possible  
Soak in cleaning solution / Brush, operate moving parts / Rinse in running water / Inspect, place on absorbent paper

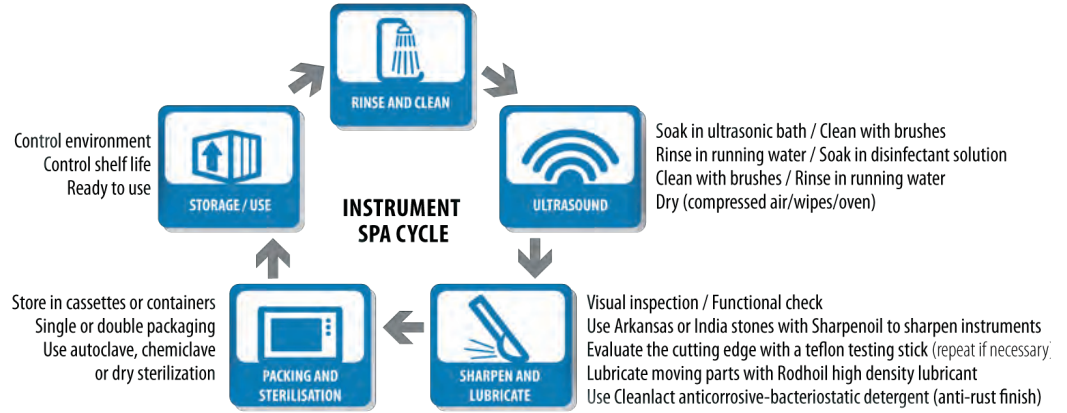

## Sharpen and Lubricate

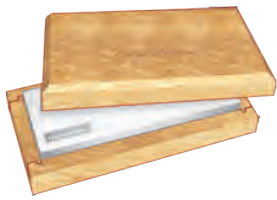

**ARKANSAS Flat Stone N° 8**  
DB-96 | 100 x 50 x 13 mm

**ARKANSAS Conical Stone N° 299**  
DB-299 | Ø 8 x 90 mm

**ARKANSAS Wedge N° 6A | DB-6A**  
**INDIA Wedge N° 6 | DB-3**

**ARKANSAS Rectangular N° 4**  
DB-4 | 100 x 12 x 25 mm

**Lubricating and sharpening oil**  
**SCHARPENOIL | DB-0L | 30 cc**

**What?** A natural stone extracted from the mountains of Arkansas. Its shape is flat and rectangular.

**What?** A natural stone extracted from the mountains of Arkansas. Its shape is cone-shaped and cylindrical.

**What?** *India*: quarried from the finest Ozark novaculite (silicon quartz) deposits. *Arkansas*: extracted from Arkansas mountains.

**What?** A natural stone extracted from the mountains of Arkansas. Its shape is flat and rectangular.

**What?** A non-coloured oil, which is an indispensable complement for lubricating and manual sharpening of surgical instruments.

**Why?** To sharpen all cutting parts of surgical instruments.

**Why?** To manually sharpen internal parts of curettes, scalers, gouges, rongeurs, etc.

**Why?** To manually sharpen internal parts of curettes and scalers.

**Why?** To sharpen all cutting parts of surgical instruments.

**Why?** To ensure perfect function and fluid movement of all surgical instruments. To activate the abrasive properties of all stones and to reduce the possibility of overheating the instruments during sharpening.

**When?** Whenever necessary to sharpen cutting parts (scissors, osteotomes, curettes, etc.).

**When?** Whenever necessary to sharpen the internal parts of surgical instruments in areas that otherwise cannot be reached.

**When?** *India*: for sharpening of excessively dull instruments or those requiring recontouring. *Arkansas*: for routine sharpening and finishing.

**When?** Whenever necessary to sharpen cutting parts (scissors, osteotomes, curettes, etc.).

**When?** It should be applied on all hinges or all other parts which are subject to movement or friction. Its use facilitates elimination of any residue present within the instrument hinges. Must **ALWAYS** be used during all sharpening operations.

## Testing

**Teflon Testing Stick**  
DB-15 | Ø 8 x 100 mm

**What?** A hard plastic stick used to test the blade of an instrument.

**Why?** To determine the sharpness of an instrument.

**When?** Always. If the blade of the instrument runs smoothly over the plastic stick, then it is blunt. A sharp instrument will grab into the stick and removes small fragments of the plastic.



## Sterilization

**Steel Cassettes with silicone racks**  
Stainless Steel

- BS-59 - (5 instruments)<sup>D</sup>
- BS-60 - (10 instruments)<sup>E</sup>
- BS-61 - (20 instruments)<sup>F</sup>

Dimensions (mm)  
185 x 35 x (75<sup>D</sup> / 135<sup>E</sup> / 185<sup>F</sup>)

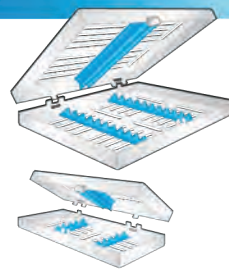

## Containers

Stainless Steel - Aluminium

- CT-555N<sup>A</sup> / CT-556N<sup>A</sup>
- CT-560N<sup>B</sup> / CT-564N<sup>B</sup>
- CT-565N<sup>C</sup> / CT-569N<sup>C</sup>

Dimensions (mm)  
300 x 140 x (40<sup>A</sup> / 70<sup>B</sup> / 100<sup>C</sup>)



## Rinse and Clean

**Detergent | CLEANLACT**  
DB-10M | DB-50M | DB-1L  
250 cc. | 500 cc. | 1000 cc.

**What?** A bacteriostatic and anticorrosive detergent.  
**Why?** Anticorrosive, bacteriostatic and lubricating action on all surgical instruments. It guarantees perfect maintenance by eliminating eventual stains, halos and browning due to sterilization, disinfection and washing with tap water.

**When?** Use periodically, diluted or concentrated (see special instructions on packaging).



**BRUSH**  
DB-11  
DB-12

**What?** Special brushes for surgical instruments.

**Why?** To remove eventual residue, organic or not, from all surgical instruments, in particular in angled, hinged and knurled parts, without damaging instrument surface. Autoclavable.

**When?** Every time, for regular cleaning of all instrumentation and in the event that an instrument is exposed for an extended period to air before being immersed in the cleaning solution.



**Special Rubber for metal**  
DB-07 | Fine  
DB-08 | Coarse

**What?** An abrasive eraser specially designed for surgical instruments.  
**Why?** To remove stains, halos or persistent burnishing from all surgical instruments without damaging the instrument surface.

**When?** Necessary when routine cleaning does not remove all stains.

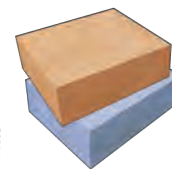



SADIQ SURGICAL CO.

1

Diagnostik, Meßinstrumente, Skalpelle  
Diagnostic, Measuring Instruments, Knives  
Diagnostica, Strumenti per misura, Bisturi  
Diagnostico, Instrumentos de medición, Bisturí  
Diagnostic, Instruments à mesurer, Bistouris



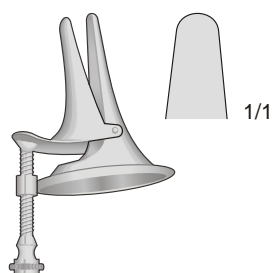

**DUPLAY  
AB-41R**  
Nasenspekulum  
Nasal specula  
Speculum nasale  
Especulo nasales  
Spèculum nasal

Speculum in Nylon  
Schwarz - Black - Nero  
Negro - Noir

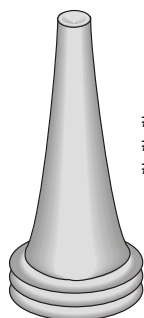

# 1 - Ø 3,0 mm  
# 2 - Ø 4,5 mm  
# 3 - Ø 5,5 mm

**AB-32R**  
Satz zu 3  
Set of 3  
Set 3 pezzi  
Jeugo de 3  
Jeu de 3  
Fig. 1-3

Spekulum für Erwachsene  
Specula for adults  
Speculum per adulti  
Especula para adultos  
Spèculum pour adultes

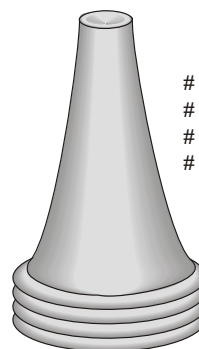

# 1 - **AB-04** - Ø 4,5 mm  
# 2 - **AB-05** - Ø 5,5 mm  
# 3 - **AB-06** - Ø 6,5 mm  
# 4 - **AB-07** - Ø 7,5 mm

**HARTMANN  
AB-09**  
Satz zu 4  
Set of 4  
Set 4 pezzi  
Jeugo de 4  
Jeu de 4  
Fig. 1-4

Laryngoskope - Laryngoscopes  
Laringoscopi - Laringoscopios - Laryngoscopes

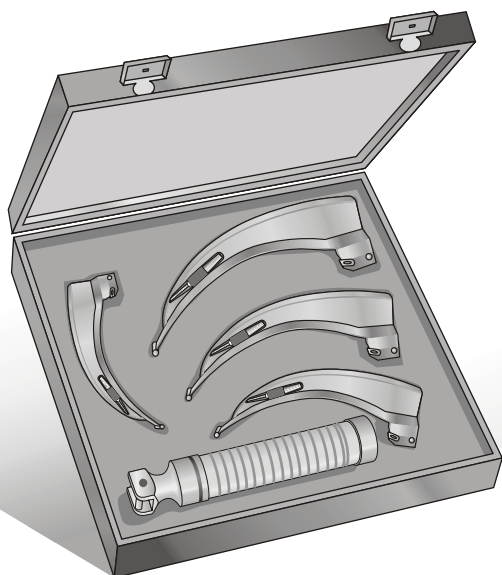

Mc INTOSH  
**AA-S104** - Set 4 lame

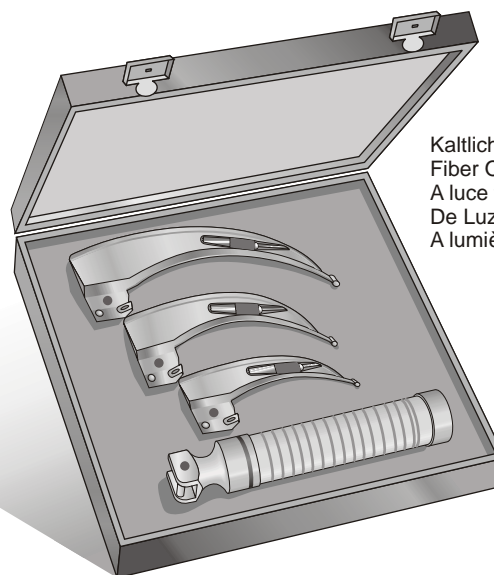

Mc INTOSH  
**AA-S503** - Set 3 lame

Kaltlicht  
Fiber Optic  
A luce fredda  
De Luz fria  
A lumière froide

Meßbereich: 0 - 15 mm  
 Measuring range: 0 - 15 mm  
 Campo di misura: 0 - 15 mm  
 Alcance de medición: 0 - 15 mm  
 Etendue de mesure: 0 - 15 mm

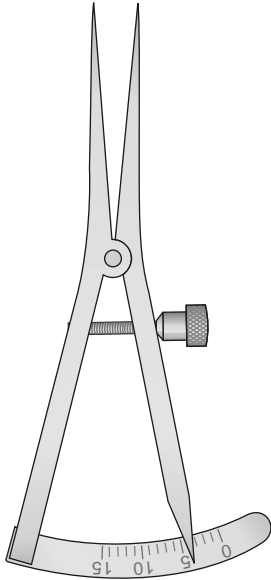

**CASTROVIEJO  
OR-15**  
90 mm

Meßbereich: 0 - 20 mm  
 Measuring range: 0 - 20 mm  
 Campo di misura: 0 - 20 mm  
 Alcance de medición: 0 - 20 mm  
 Etendue de mesure: 0 - 20 mm

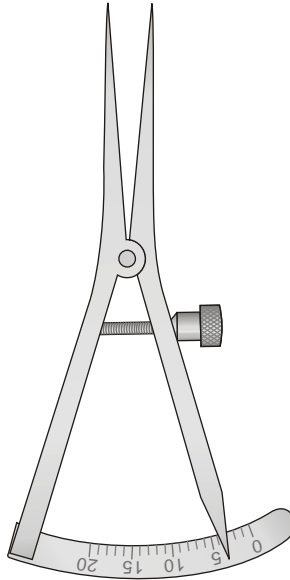

**CASTROVIEJO  
OR-17**  
90 mm

Meßbereich: 0 - 20 mm  
 Measuring range: 0 - 20 mm  
 Campo di misura: 0 - 20 mm  
 Alcance de medición: 0 - 20 mm  
 Etendue de mesure: 0 - 20 mm

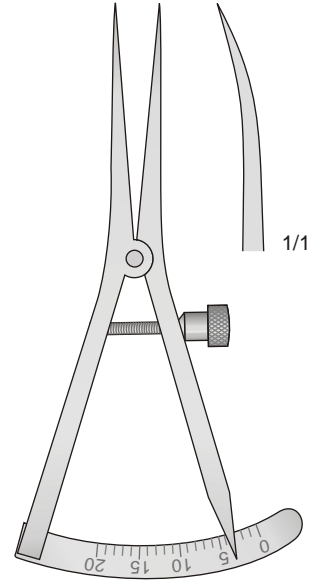

**CASTROVIEJO  
OR-19**  
90 mm

Meßbereich: 0 - 40 mm  
 Measuring range: 0 - 40 mm  
 Campo di misura: 0 - 40 mm  
 Alcance de medición: 0 - 40 mm  
 Etendue de mesure: 0 - 40 mm

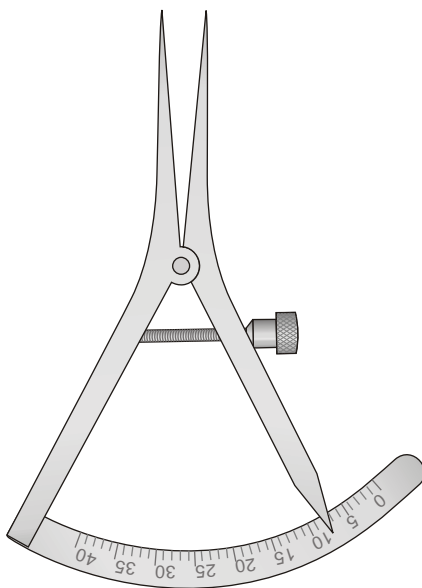

**CASTROVIEJO  
OR-11**  
90 mm

Meßbereich: 0 - 40 mm  
 Measuring range: 0 - 40 mm  
 Campo di misura: 0 - 40 mm  
 Alcance de medición: 0 - 40 mm  
 Etendue de mesure: 0 - 40 mm

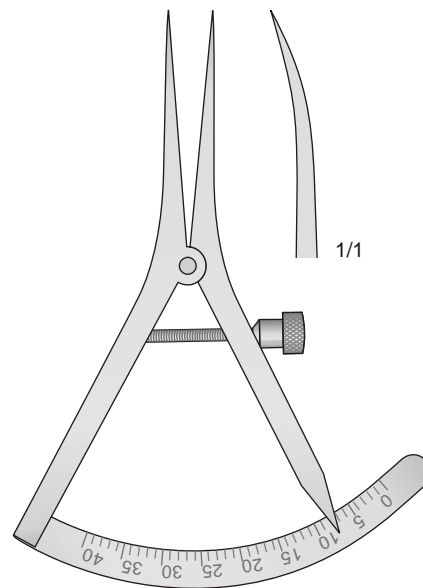

**CASTROVIEJO  
OR-13**  
90 mm



Messinstrumente

Measuring instruments

Strumenti per misura

Instrumentos para medir

Instruments à mesurer

Meßbereich: 0 - 80 mm  
 Measuring range: 0 - 80 mm  
 Campo di misura: 0 - 80 mm  
 Alcance de medición: 0 - 80 mm  
 Etendue de mesure: 0 - 80 mm



**OR-40**  
125 mm

Meßbereich: 0 - 80 mm  
 Measuring range: 0 - 80 mm  
 Campo di misura: 0 - 80 mm  
 Alcance de medición: 0 - 80 mm  
 Etendue de mesure: 0 - 80 mm

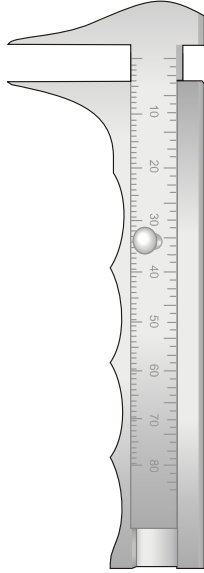

**OR-45**  
95 mm



**LS-04**  
80 mm



**LS-07**  
50 mm



**LS-08**  
120 mm

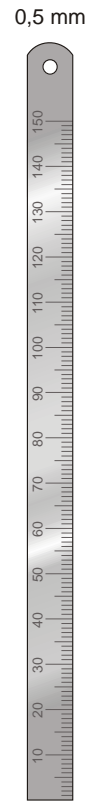

**LS-09**  
150 mm



**LS-06**  
300 mm

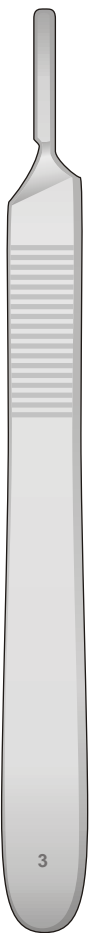
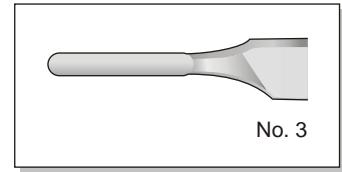

**MA-B3**  
Fig. 3

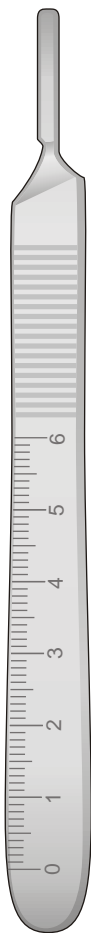

**MA-B3M**  
Fig. 3M



**MA-B7**  
Fig. 7



**MA-B7K**  
Fig. 7k



**MA-B1**  
Fig. 5

Skalpеллgriffe  
Skalpеллklingen, steril

Scalpel handles  
Scalpel blades, sterile

Manici per bisturi  
Lame da bisturi sterili

Mangos de bisturí  
Hojas de bisturí  
estériles

Manches de bistouris  
Lames de bistouris  
stériles

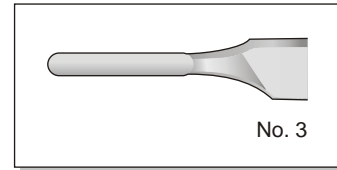

1,5 mm

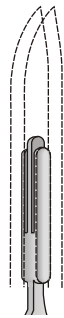

**MA-B8**

2,5 mm

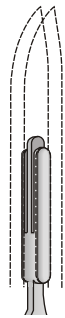

**MA-B9**



**LB-10**  
Fig. 10



**LB-11**  
Fig. 11

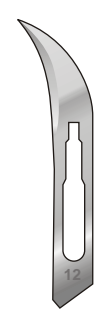

**LB-12**  
Fig. 12



**LB-13**  
Fig. 13

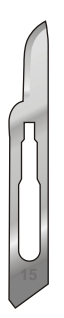

**LB-15**  
Fig. 15

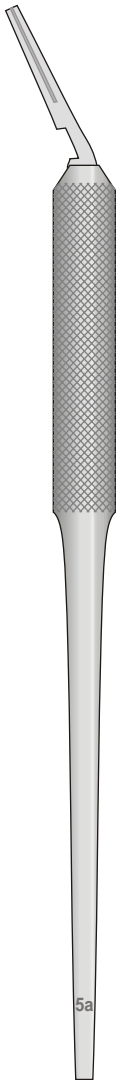

**MA-B2**  
Fig. 5a



**MA-B8/MA-B9**  
155 mm

Packung mit 100 Stück  
Package with 100 units  
Scatola da 100 pezzi  
Paquete con 100 unidades  
Boîte avec 100 lames

Skalpelligriffe  
Skalpellslingen, steril

Scalpel handles  
Scalpel blades, sterile

Manici per bisturi  
Lame da bisturi sterili

Mangos de bisturí  
Hojas de bisturí  
estériles

Manches de bistouris  
Lames de bistouris  
stériles

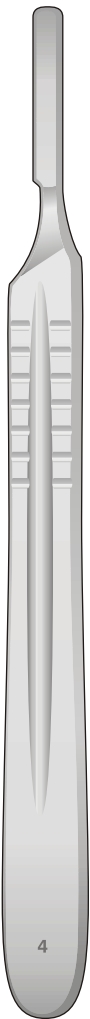
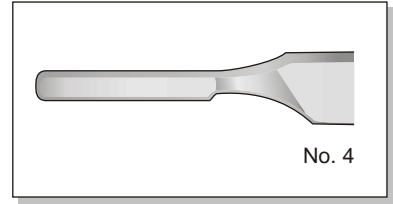

**MA-B4**  
Fig. 4

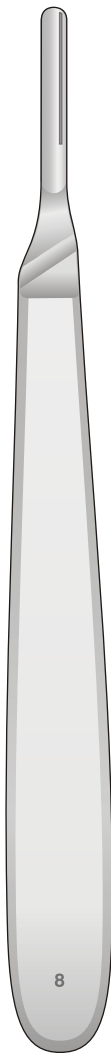

**MA-B10**  
Fig. 8



**LB-20**  
Fig. 20



**LB-21**  
Fig. 21



**LB-22**  
Fig. 22



**LB-23**  
Fig. 23



**LB-25**  
Fig. 25

Packung mit 100 Stück  
Package with 100 units  
Scatola da 100 pezzi  
Paquete con 100 unidades  
Boîte avec 100 lames

Mikro-Skalpellklingen,  
Skalpellgriffe

Micro Scalpel Blades,  
Scalpel handles

Micro lame per bisturi,  
Manici per bisturi

Micro hojas de bisturí,  
Mangos de bisturí

Micro lame de bistouris,  
Manches pour bistouris



**LB-361**



**LB-362**



**LB-364**



**LB-365**



**LB-367**



**LB-368**

Packung mit 10 Stück  
Package with 10 units  
Confezione 10 pezzi  
Paquete con 10 unidades  
Boîte avec 10 lames



**LB-363**

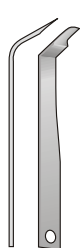

**LB-366**



**LB-369**

Packung mit 1 Stück  
Package with 1 unit  
Confezione 1 pezzo  
Paquete con 1 unidade  
Boîte avec 1 lame

Für Mikro-Skalpellklingen - For Micro Scalpel Blades  
Per Micro Lame - Para Micro Hojas  
Pour Micro-Lame de bistouris



**NK-1**  
100 mm



**NK-2**  
150 mm



**BB-36**  
125 mm



**BB-46**  
135 mm



**BB-48** - 155 mm  
**BB-50** - 180 mm  
**BB-52** - 200 mm



1/1



1/1

CASPAR  
**BB-50**    **BB-52**

Rasierklingen  
Klingenbrecher

Razor Blades  
Blade removing forceps

Lamette da rasoio  
Pinze per rimozione lame

Hojas de afeitár  
Pinza para quitar hojas

Lames de rasoir  
Pincés pour enlever  
les lames

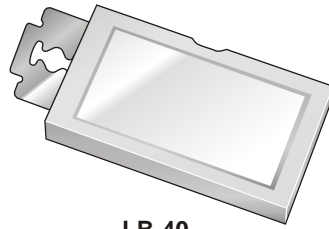

**LB-40**

Packung 10 Klingen  
Package 10 blades  
Scatola da 10 lame  
Cajita de 10 hojas  
Boite de 10 lames

Klingen-Entferner - Blade Remover  
Per rimozione lame - Saca-Hojas  
Enlève-Lames

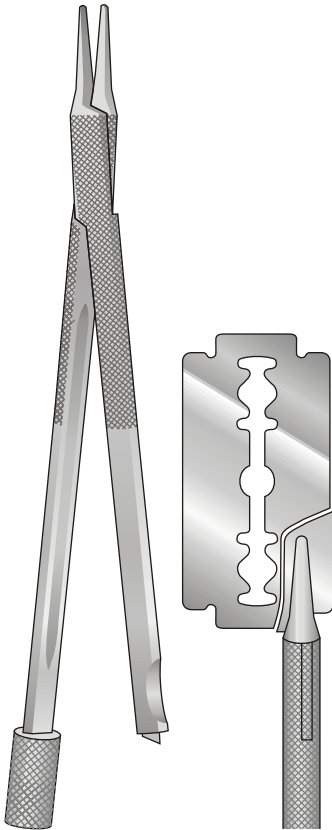

**NK-12**  
120 mm

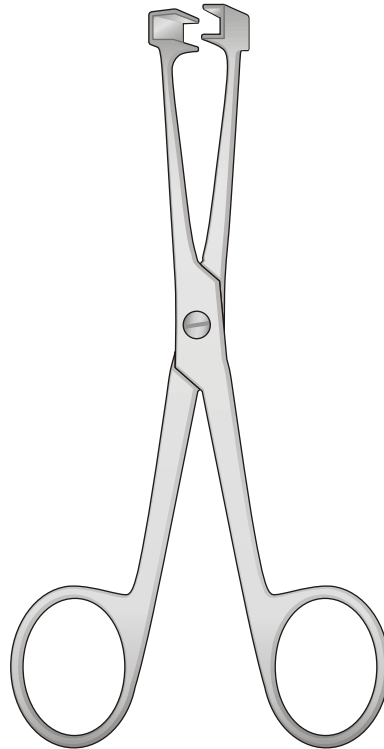

**GS-18**  
135 mm

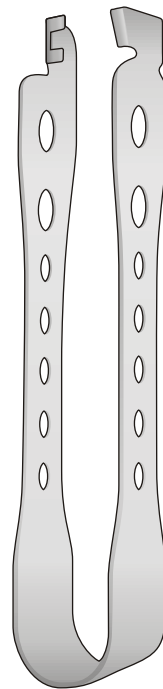

**GS-16**  
115 mm

Rhinoplastikmesser

Rhinoplasty Knives

Bisturi per rinoplastica

Cuchillos para rinoplastica

Couteaux pour Rhino-plastie

Spitz  
Sharp  
Acuto - Agudas  
Pointu



JOSEPH  
NK-430/NK-431

Gerade  
Straight  
Diritto - Recto  
Droit



1/1  
NK-430  
150 mm

Gebogen  
Curved  
Curvo - Curvo  
Courbe



1/1  
NK-431  
150 mm

Stumpf  
Blunt  
Smussa - Romas  
Mousse



JOSEPH  
NK-432/NK-433

Gerade  
Straight  
Diritto - Recto  
Droit



1/1  
NK-432  
150 mm

Gebogen  
Curved  
Curvo - Curvo  
Courbe



1/1  
NK-433  
150 mm



JOSEPH  
NK-100  
150 mm

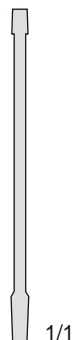

1/1



CONVERSE  
NK-101  
160 mm

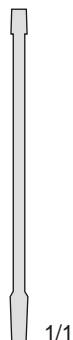

1/1



FOMON  
NK-102  
160 mm

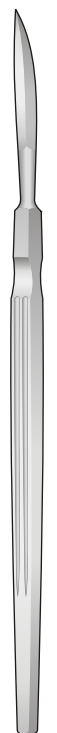

FOMON  
FR-176  
160 mm

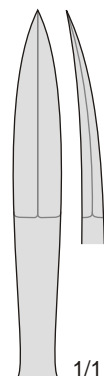

1/1

1/1



COTTLE  
FR-12  
150 mm



COTTLE  
FR-48  
150 mm

Rhinoplastikmesser

Rhinoplasty Knives

Bisturi per rinoplastica

Cuchillos para rinoplastica

Couteaux pour Rhino-plastie



**FREER  
FR-11**  
175 mm

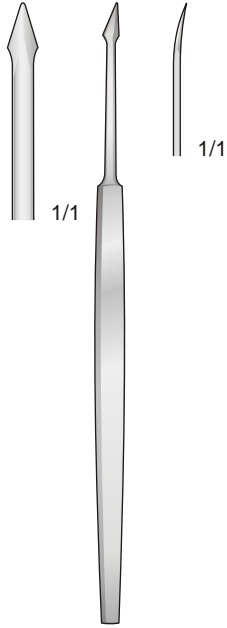

**MASING  
FR-168**  
130 mm

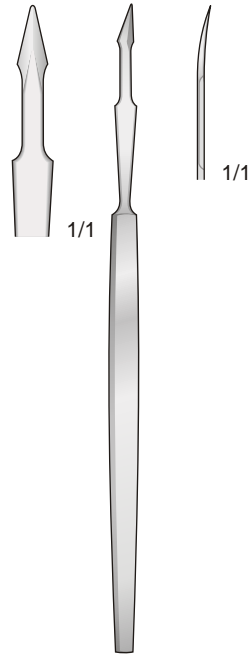

**MASING  
FR-169**  
130 mm

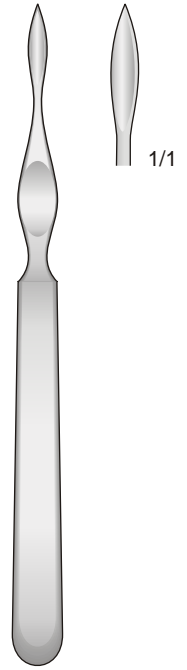

**BALLENGER  
FR-175**  
140 mm



**FREER  
FR-18**  
165 mm



**BRÜNINGS  
FR-177**  
165 mm

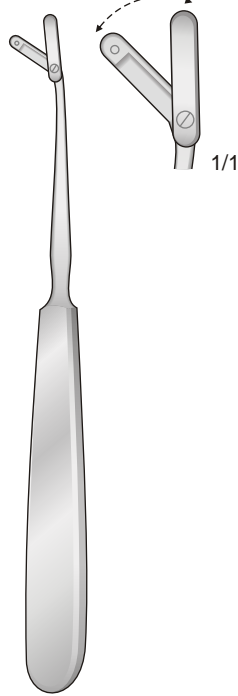

**MALTZ  
FR-19**  
160 mm

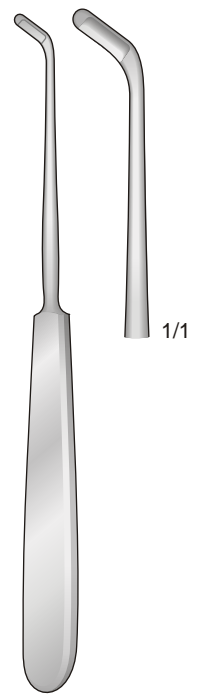

**JOSEPH  
FR-49**  
160 mm





2

Scheren  
Scissors  
Forbici  
Tijeras  
Ciseaux



Mikro Scheren

Micro scissors

Micro forbici

Micro tijeras

Micro ciseaux

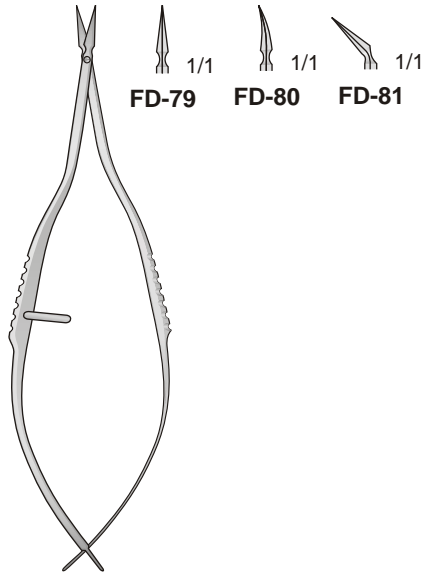

VANNAS  
FD-79/FD-81  
85 mm

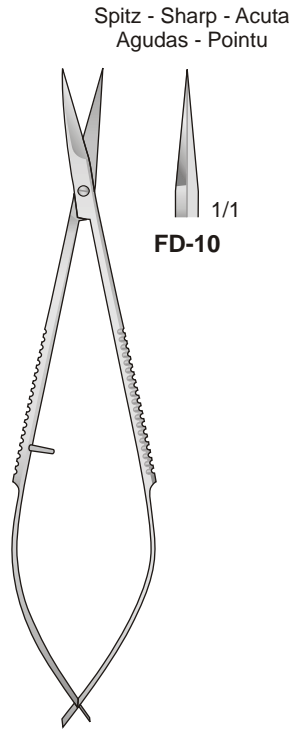

NOYES  
FD-10  
120 mm

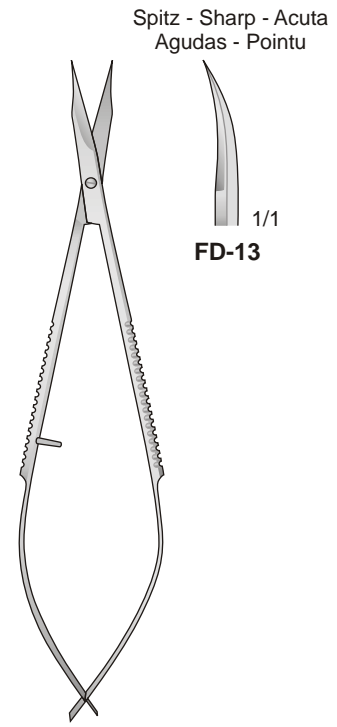

WESTCOTT  
FD-13  
120 mm

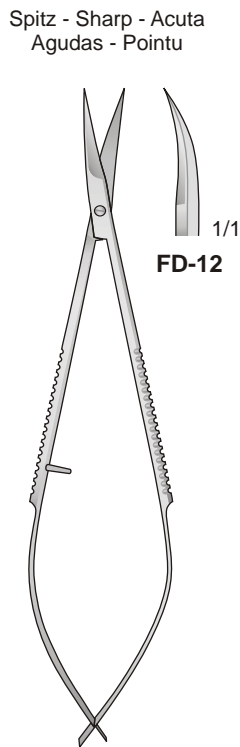

NOYES  
FD-12  
120 mm

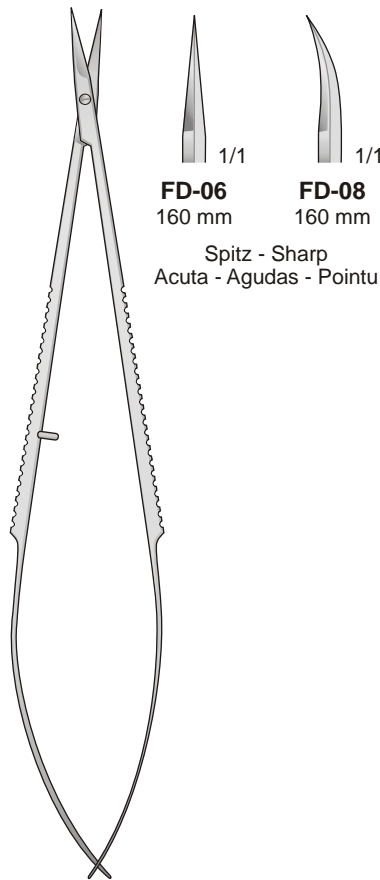

FD-06/FD-08  
160 mm

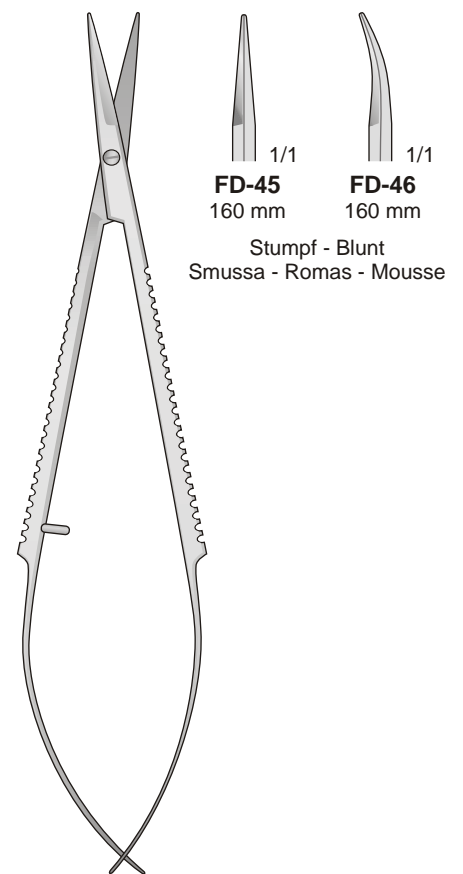

FD-45/FD-46  
160 mm

Stumpf - Blunt  
Smussa - Romas - Mousse

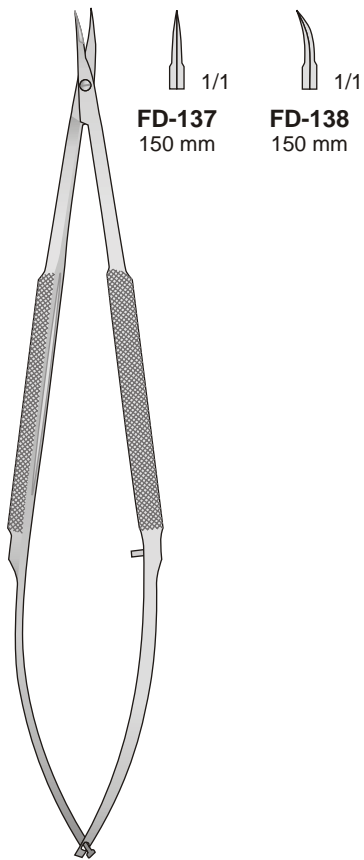

**FD-137**  
150 mm

**FD-138**  
150 mm

**FD-137/FD-138**  
150 mm

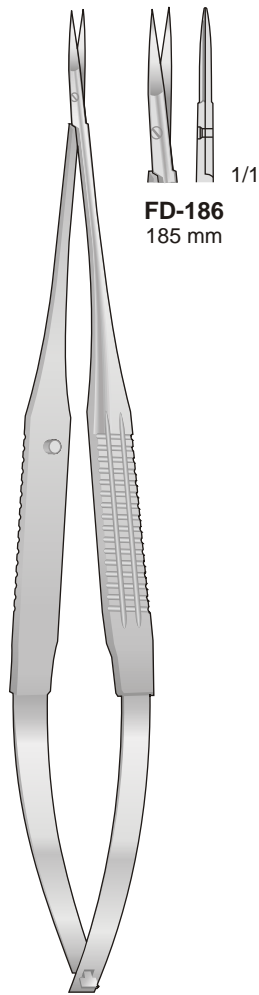

**FD-186**  
185 mm

**YASARGIL**  
**FD-186**  
185 mm

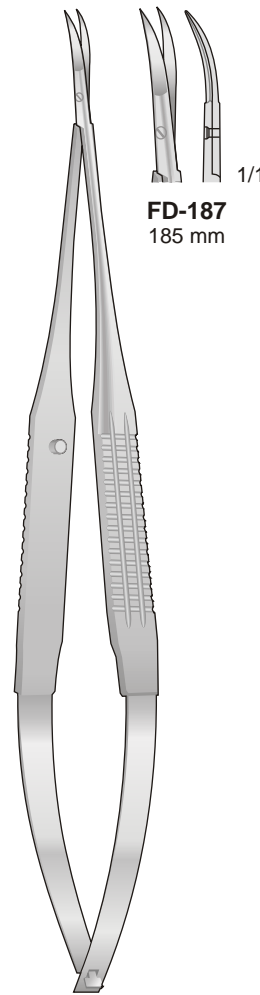

**FD-187**  
185 mm

**JACOBSON**  
**FD-187**  
185 mm

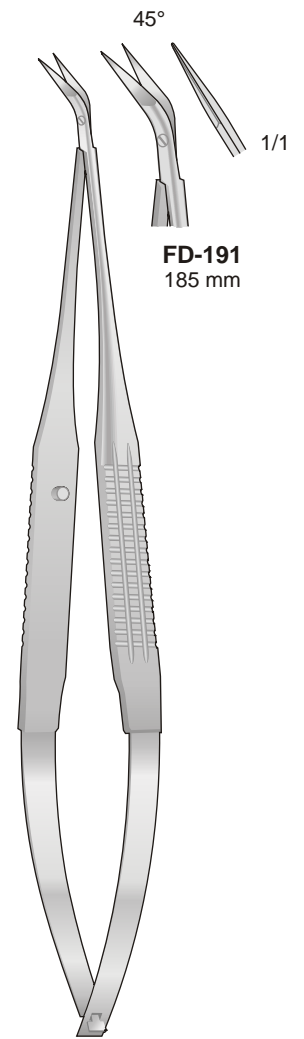

**FD-191**  
185 mm

**POTTS-YASARGIL**  
**FD-191**  
185 mm

Mikro Scheren

Micro scissors

Micro forbici

Micro tijeras

Micro ciseaux

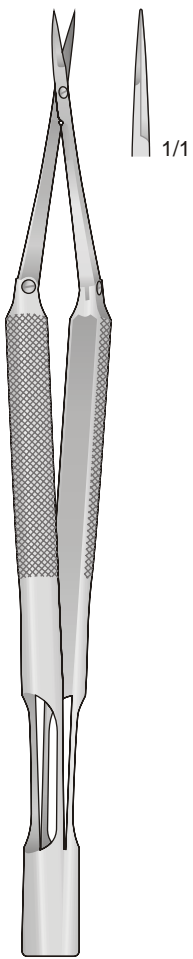

**BROCK  
FD-221**  
150 mm

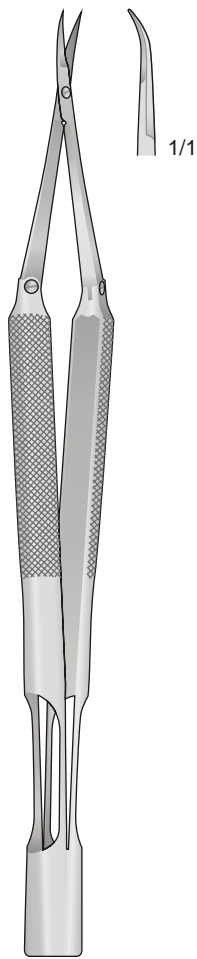

**BROCK  
FD-223**  
150 mm

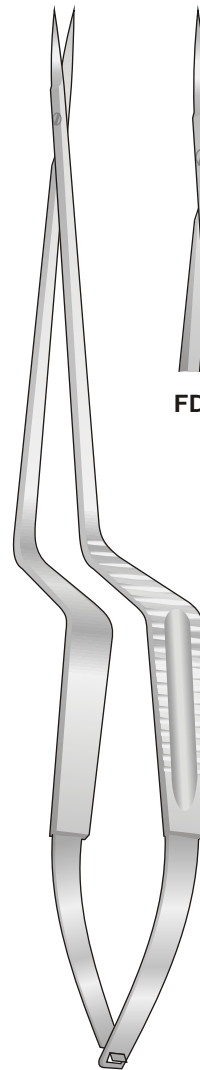

**FD-306/FD-311**  
190 mm



**FD-306**

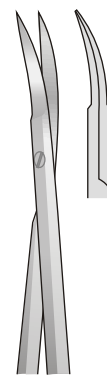

**FD-307**

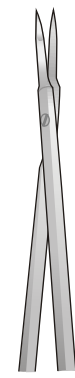

**FD-310**

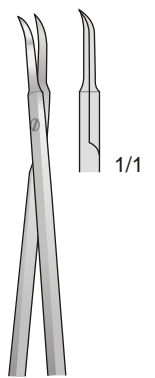

**FD-311**

**Forbici ad anelli grandi**

Iris scissors

Blepharoplasty  
Blefaroplastica

Spitz - Sharp  
Acuta - Aguda  
Pointu

Spitz - Sharp  
Acuta - Aguda  
Pointu

Stumpf - Blunt  
Smussa - Romas  
Mousse

Spitz - Sharp  
Acuta - Aguda  
Pointu

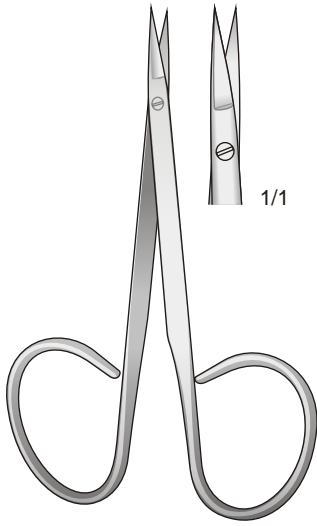

**FG-200**  
95 mm

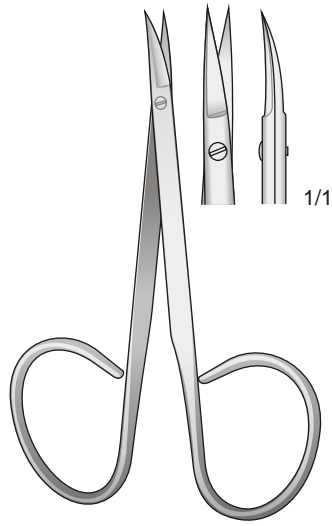

**FG-201**  
95 mm

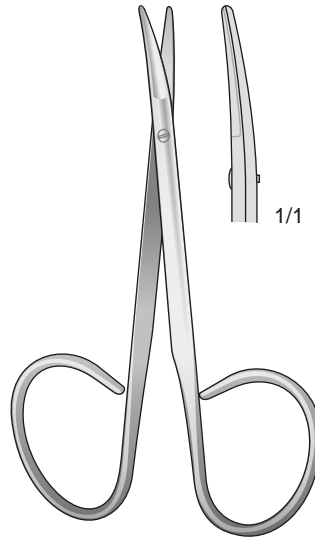

**FG-202**  
95 mm

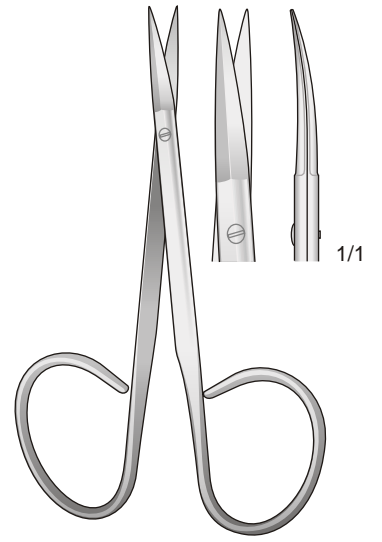

**FG-203**  
105 mm

Iris scissors

Stumpf - Blunt  
Smussa - Romas  
Mousse

Stumpf - Blunt  
Smussa - Romas  
Mousse

Spitz - Sharp  
Acuta - Aguda  
Pointu

Spitz - Sharp  
Acuta - Aguda  
Pointu

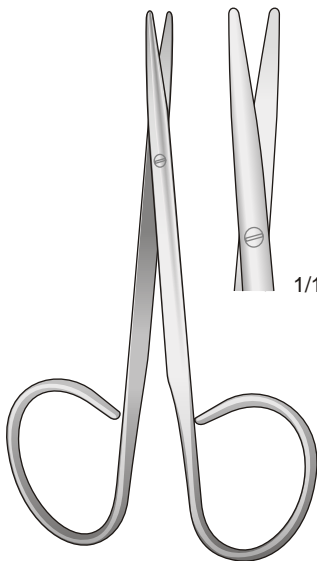

**FG-204**  
100 mm

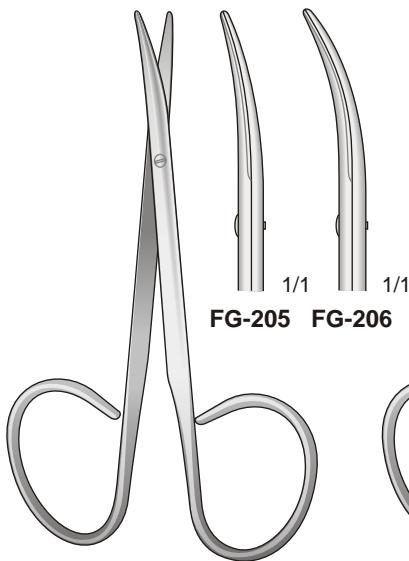

**FG-205/FG-206**  
100 mm

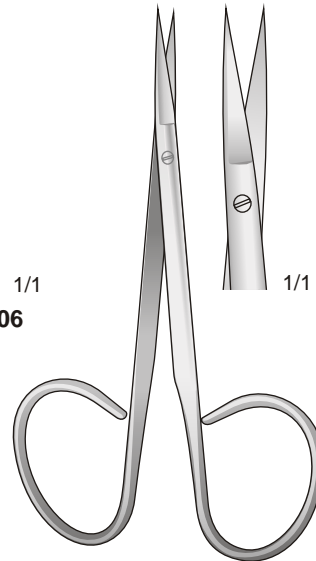

**FG-207**  
105 mm

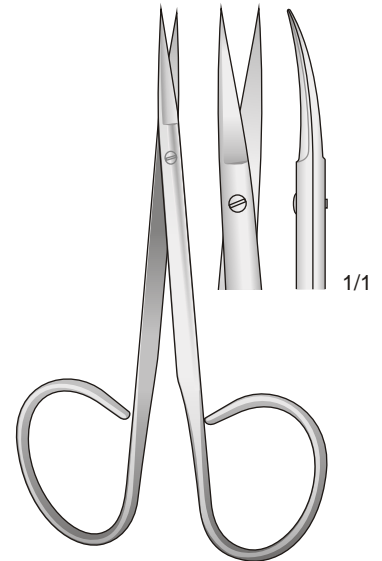

**FG-208**  
105 mm

**Forbici ad anelli grandi**

Stumpf - Blunt  
Smussa - Romas  
Mousse

Stumpf - Blunt  
Smussa - Romas  
Mousse

Spitz - Sharp  
Acuta - Aguda  
Pointu

Spitz - Sharp  
Acuta - Aguda  
Pointu

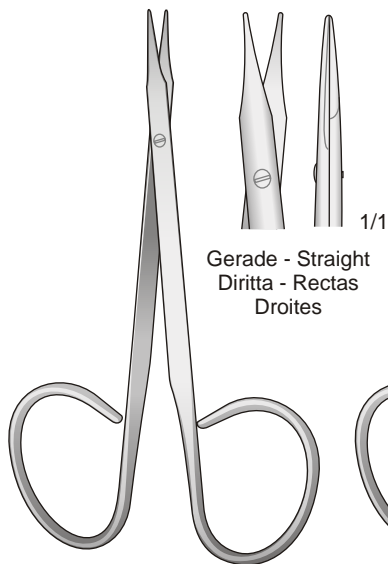

STEVENS  
**FG-209**  
100 mm

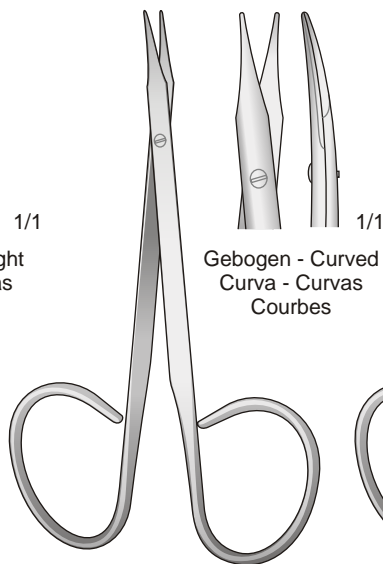

STEVENS  
**FG-210**  
100 mm

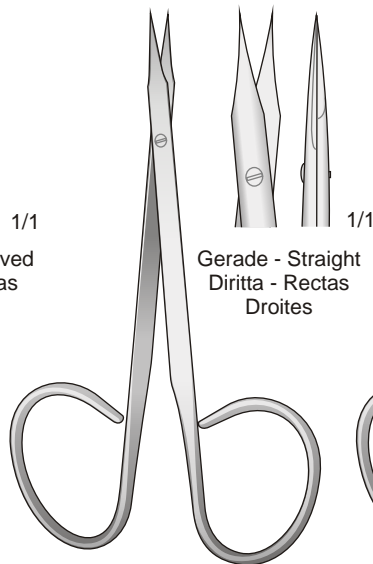

WALTON  
**FG-211**  
100 mm

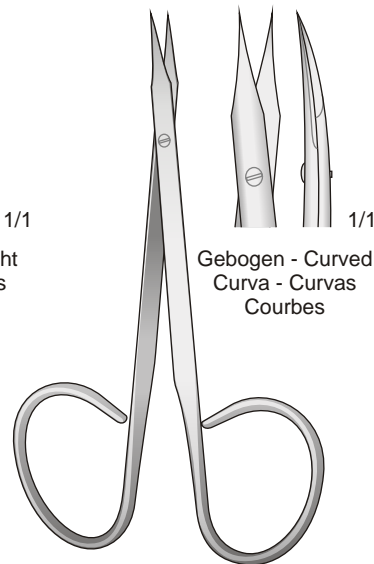

WALTON  
**FG-212**  
100 mm

Gerade - Straight  
Diritta - Rectas  
Droites

Gebogen - Curved  
Curva - Curvas  
Courbes

Gerade - Straight  
Diritta - Rectas  
Droites

Gebogen - Curved  
Curva - Curvas  
Courbes

Spitz - Sharp  
Acuta - Aguda  
Pointu

Gezahnt - Serrated  
Dentellata - Dentadas  
Dentelés

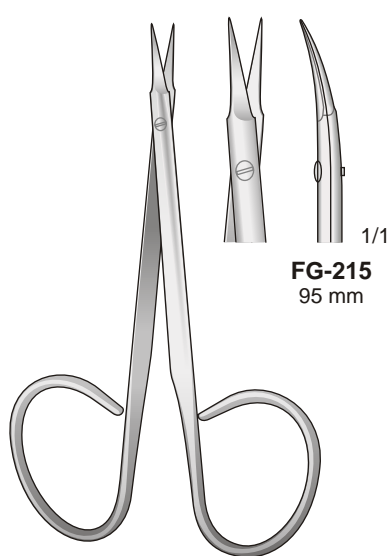

STITCH  
**FG-215/FG-216**

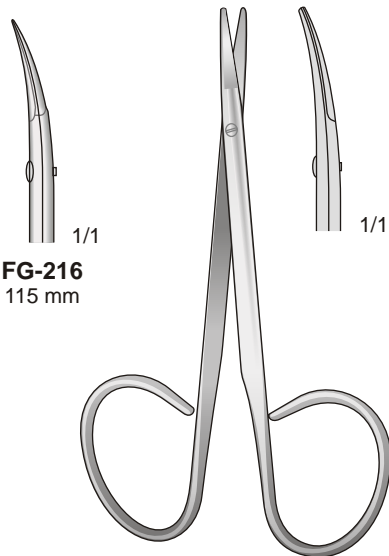

RAGNELL  
**FG-217**  
100 mm

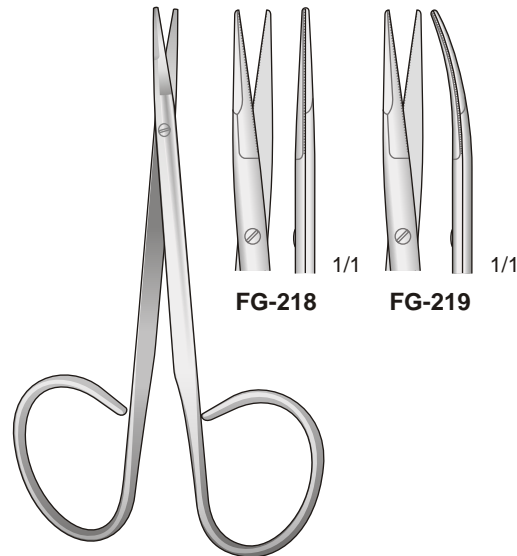

KAYE  
**FG-218/FG-219**  
105 mm

**FG-215**  
95 mm

**FG-216**  
115 mm

**FG-218**

**FG-219**

Feine Scheren

Delicate scissors

Forbici delicate

Tijeras finas

Ciseaux délicate

Spitz - Pointed - Acute  
Agudas - Pointus

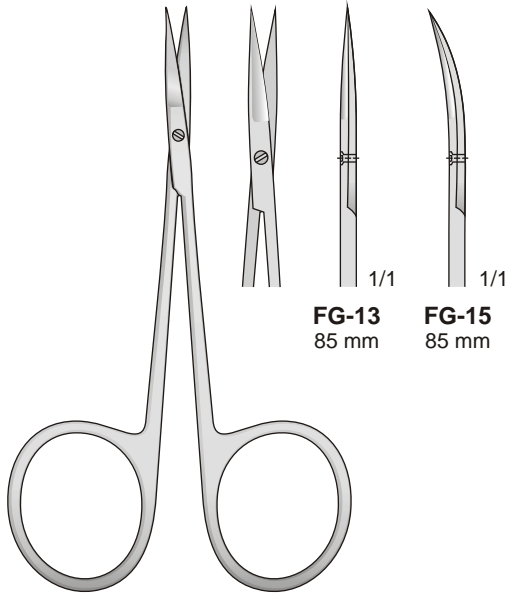

**MICRO-IRIS**  
**FG-13/FG-15**  
85 mm

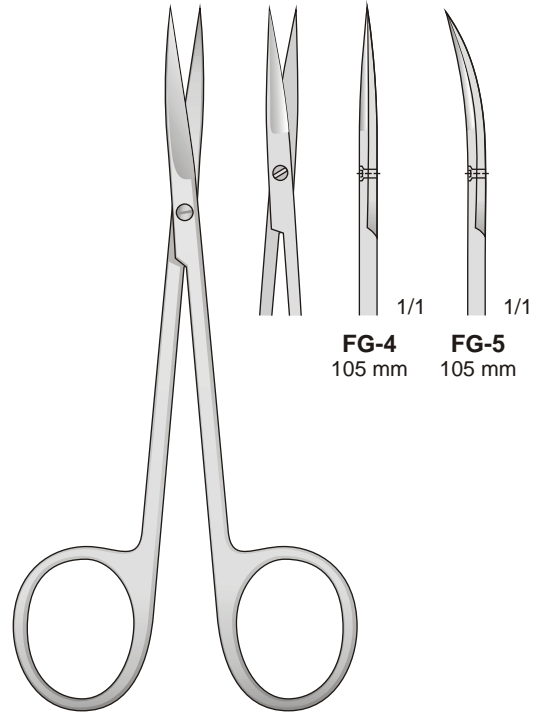

**FG-4/FG-5**  
105 mm

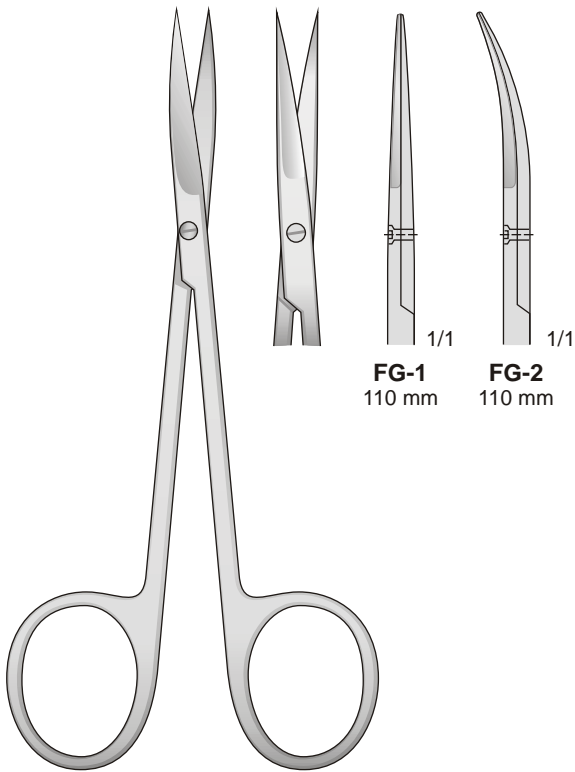

**IRIS**  
**FG-1/FG-2**  
110 mm

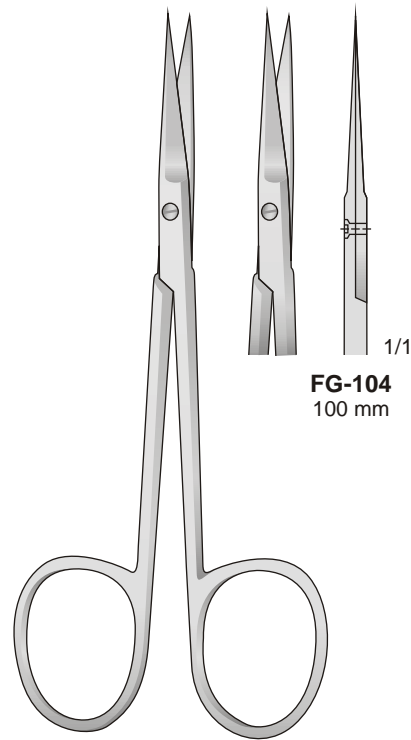

**FG-104**  
100 mm



Feine Scheren

Delicate scissors

Forbici delicate

Tijeras finas

Ciseaux délicate

Stumpf - Blunt  
Smussa - Romo - Émoussé

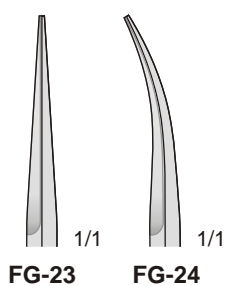
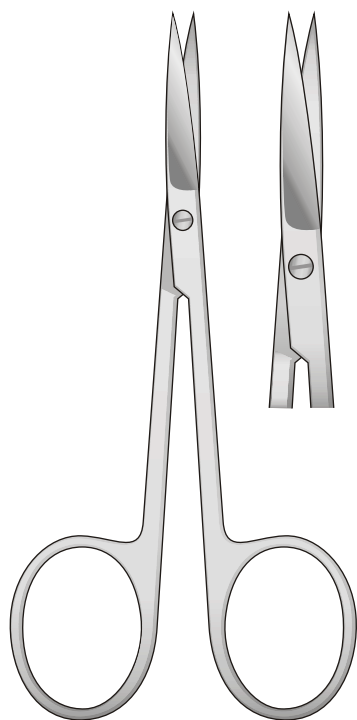

**FG-23/FG-24**  
110 mm

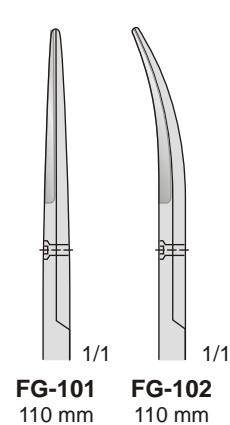
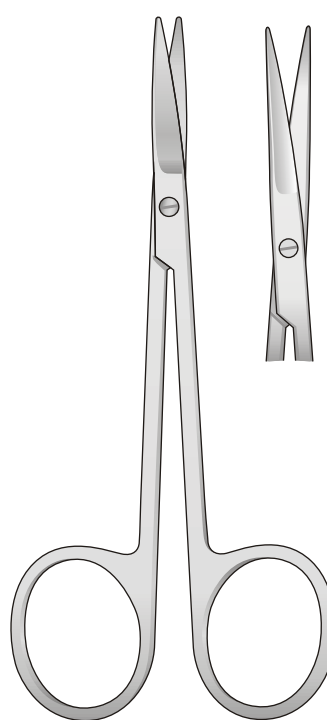

**FG-101/FG-102**  
110 mm

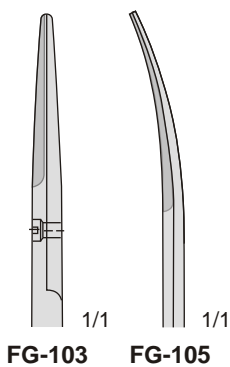
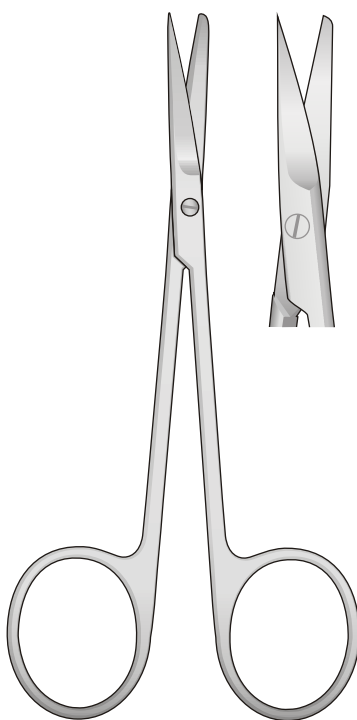

**FG-103/FG-105**  
110 mm

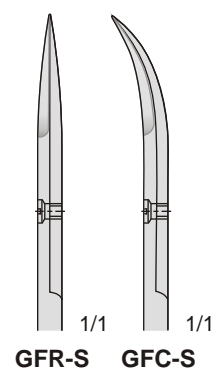
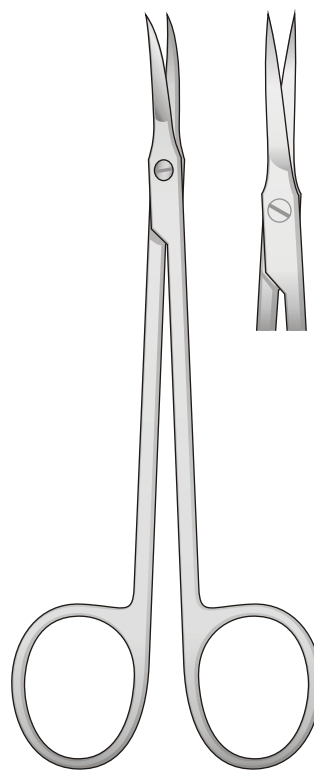

**GFR-S/GFC-S**  
120 mm

Feine Scheren

Delicate scissors

Forbici delicate

Tijeras finas

Ciseaux délicate

Stumpf  
Blunt  
Smussa  
Romas  
Mousse

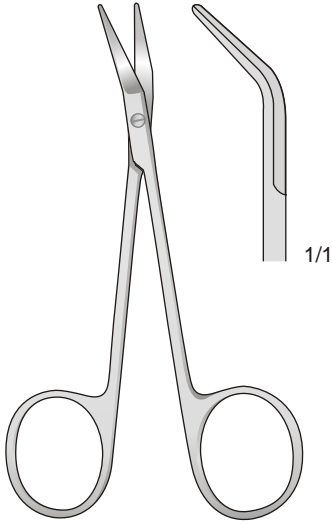

**GRAEFE  
FG-30**  
100 mm

Spitz  
Sharp  
Acuta  
Aguda  
Pointu

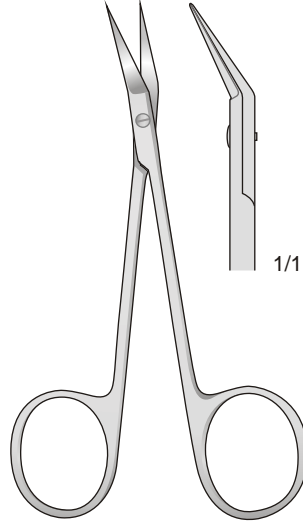

**WILMER  
FG-122**  
105 mm

Spitz  
Sharp  
Acuta  
Aguda  
Pointu

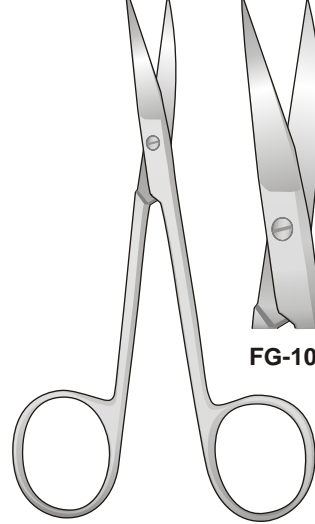

**COTTLE-MASING  
FG-108/FG-109**  
105 mm

Stumpf  
Blunt  
Smussa  
Romas  
Mousse

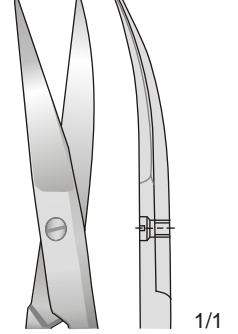

**FG-109**

Spitz  
Sharp  
Acuta  
Aguda  
Pointu

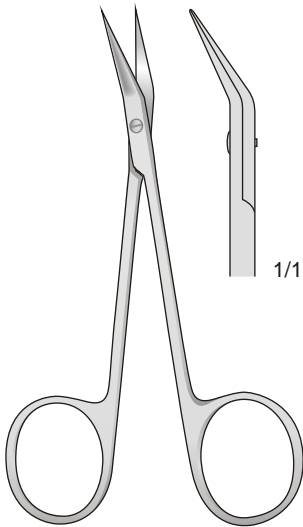

**BIRO  
FG-94**  
100 mm



**FG-3**

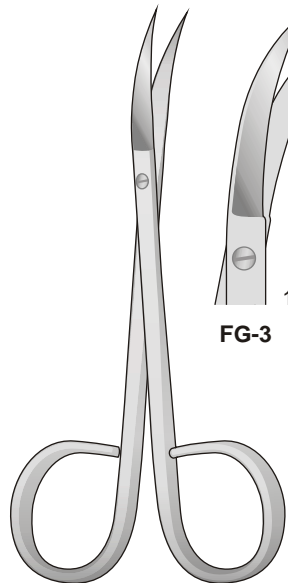

**FG-3**  
115 mm

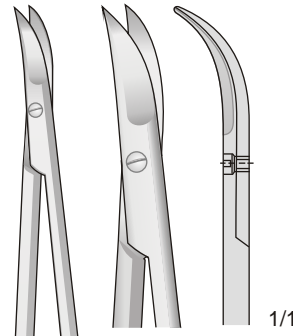

**CHADWICK  
FG-39**  
115 mm

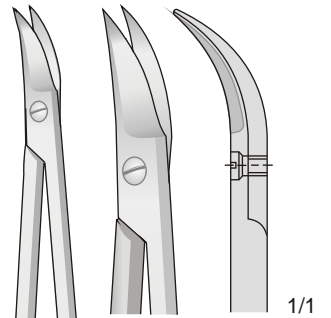

**QUINBY  
FG-38**  
130 mm

Chirurgische Scheren

Operating Scissors

Forbici chirurgiche

Tijeras para cirugía

Ciseaux chirurgicaux

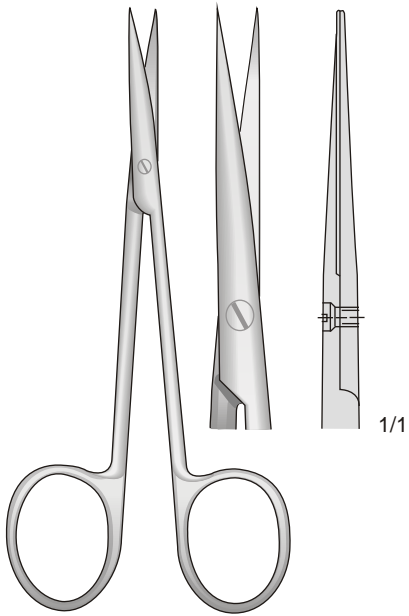

**KILNER**  
**FG-58**  
115 mm

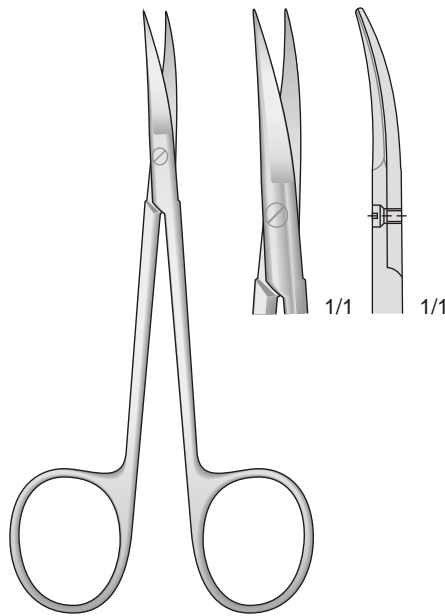

**COTTLE**  
**FG-59**  
115 mm

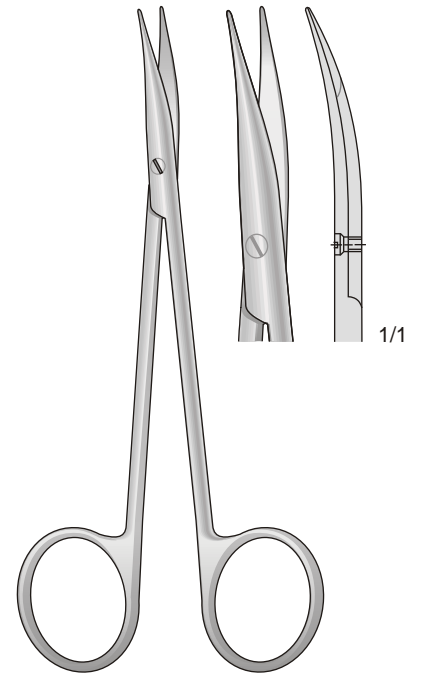

**JAMESON-WERBER**  
**FG-123**  
130 mm

Stumpf - Blunt  
Smussa - Romo - Émoussé

Spitz - Sharp  
Acuta - Agudo - Aigu

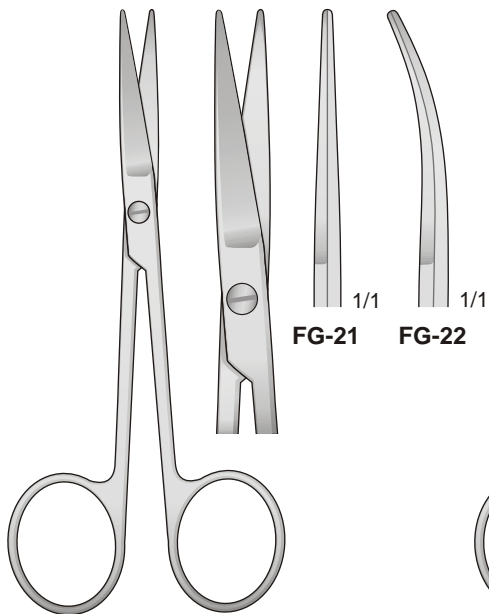

**FG-21/FG-22**  
115 mm

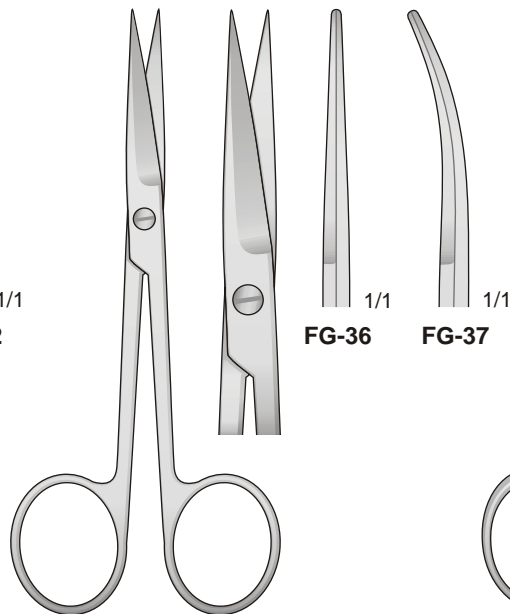

**FG-36/FG-37**  
115 mm

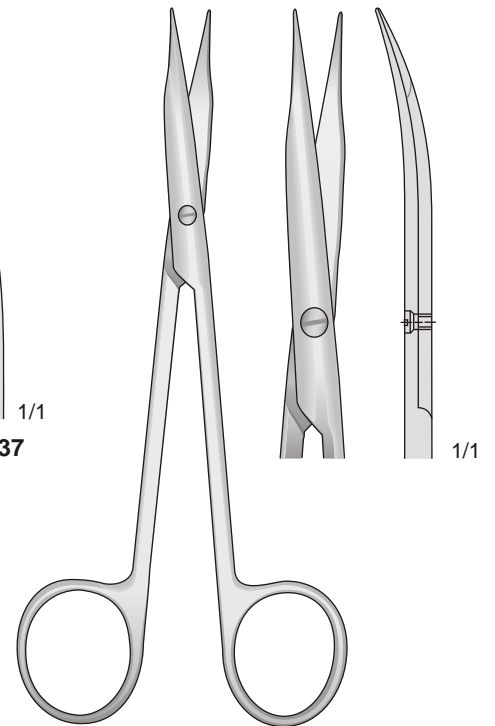

**JAMESON**  
**FG-124**  
145 mm

Gezahnt - Sawedge - Dentellata - Dentadas - Dentelé

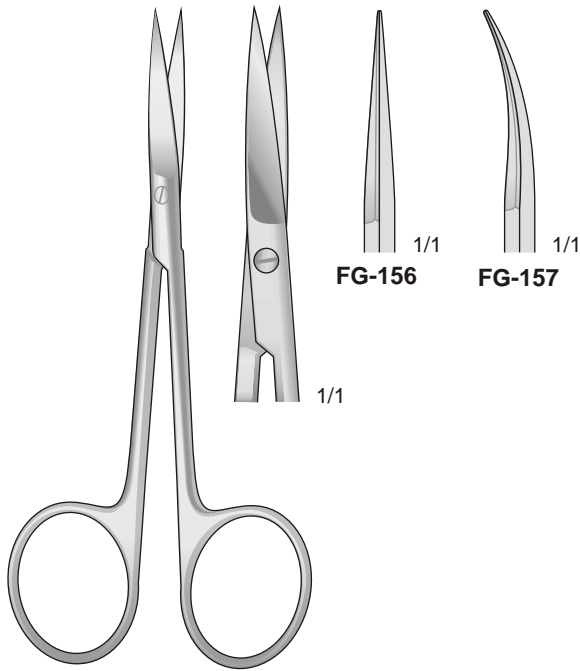

**FG-156/FG-157**  
110 mm

Gezahnt - Sawedge - Dentellata - Dentadas - Dentelé

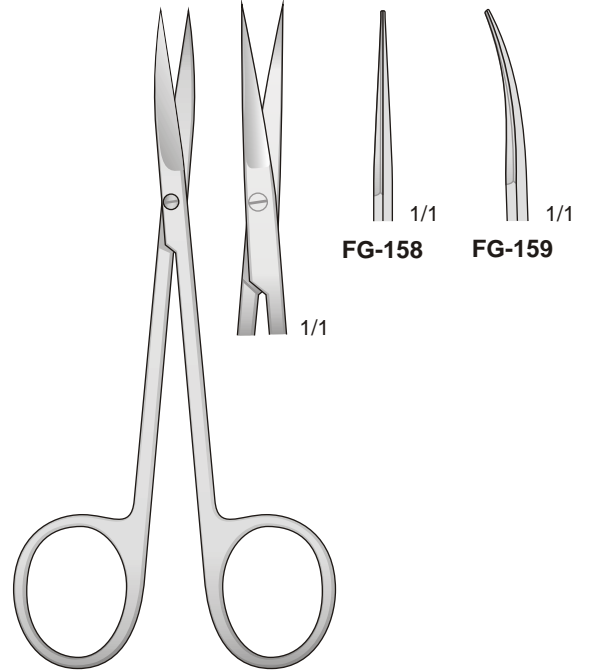

**FG-158/FG-159**  
110 mm

Plastikscheren  
Plastic Scissors  
Forbici per Plastica

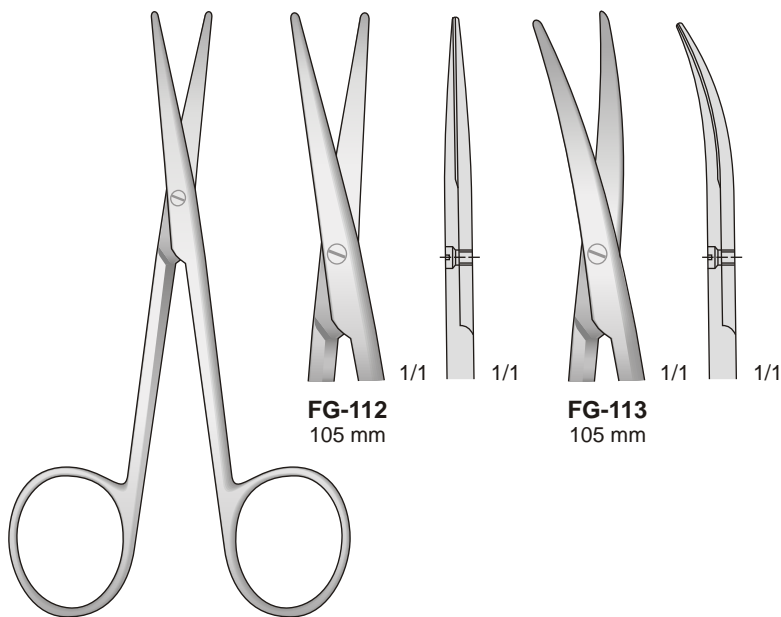

**COTTLE-KNAPP**  
**FG-112/FG-113**  
105 mm  
(LEXER-BABY)

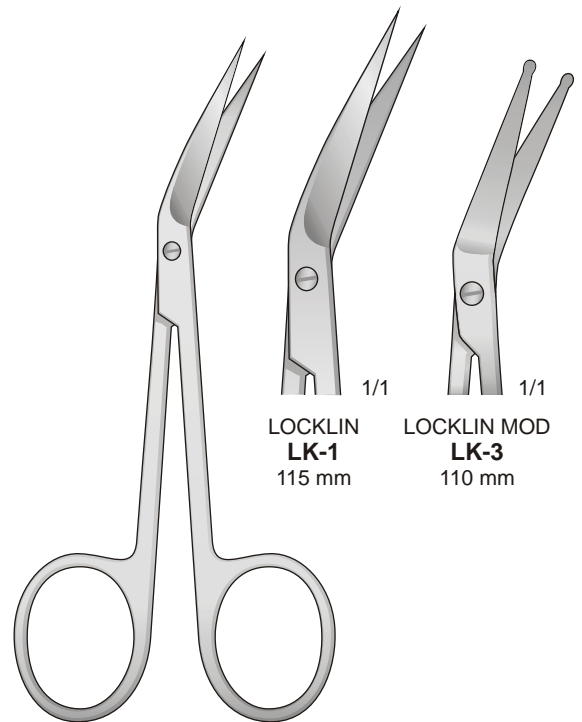

**LK-1/LK-3**

Feine Scheren

Delicate scissors

Forbici delicate

Tijeras finas

Ciseaux délicate

Gezahnt - Sawedge - Dentellata - Dentadas - Dentelé

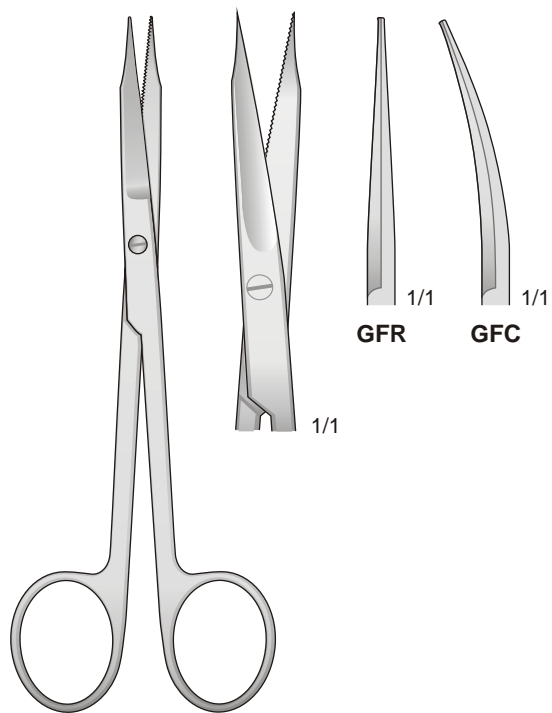

GOLDMAN-FOX  
**GFR/GFC**  
120 mm

S Form

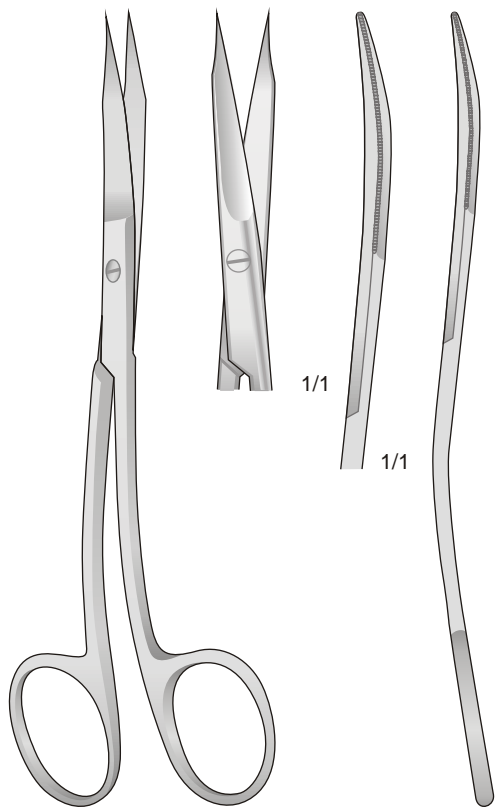

GOLDMAN-FOX  
**GFS**  
130 mm

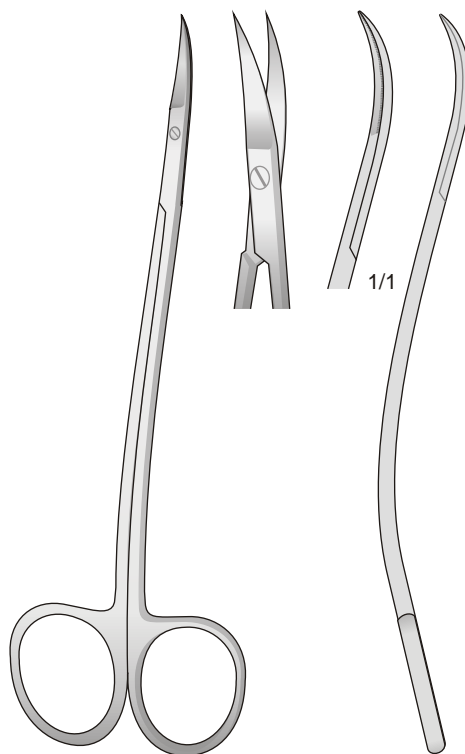

LA GRANGE  
**LG-1**  
115 mm

Stumpf - Blunt - Smusse - Romas - Mouses

Spitz - Pointed - Acute - Agudas - Pointus

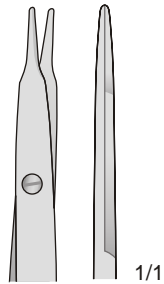
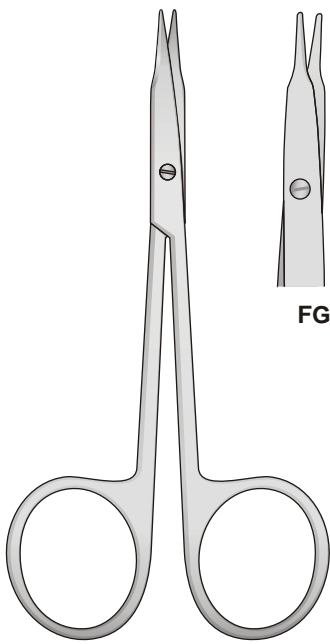

**FG-50**

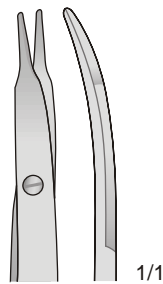

**FG-51**

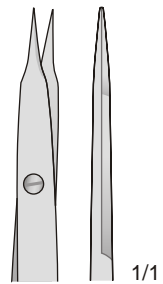

**FG-52**

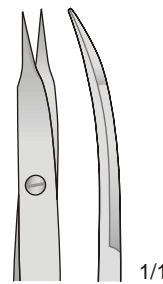

**FG-53**

**STEVENS**  
**FG-50/FG-53**  
110 mm

Stumpf - Blunt - Smussa  
Romas - Mousse

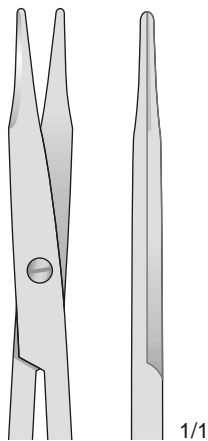
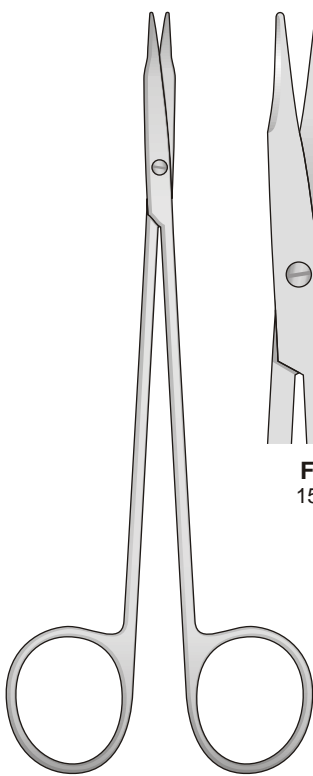

**FG-54**  
150 mm

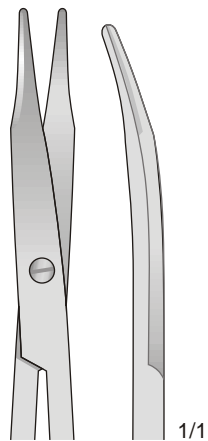

**FG-55**  
150 mm

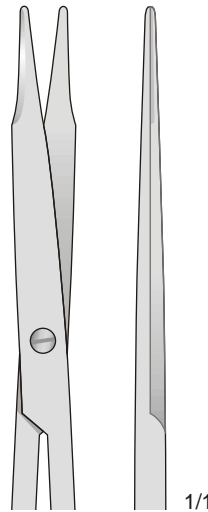

**FG-56**  
180 mm

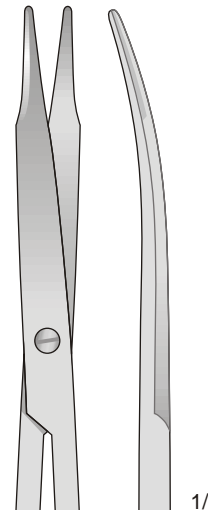

**FG-57**  
180 mm

**REYNOLDS**  
**FG-54/FG-57**

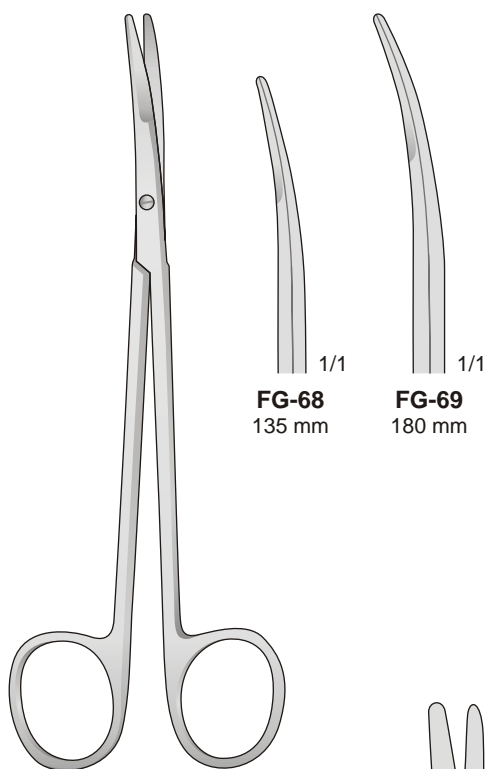

GLASSMAN  
FG-68/FG-69

FG-68  
135 mm

FG-69  
180 mm

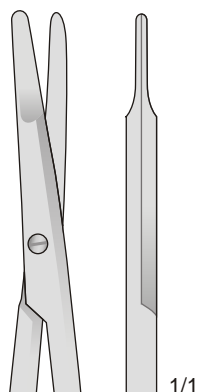

FG-66  
120 mm

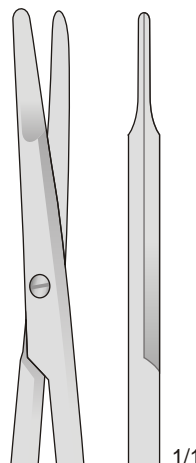

FG-19R  
135 mm

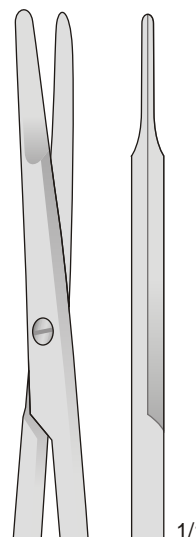

FG-6R  
150 mm



KILNER  
FG-6C/FG-66

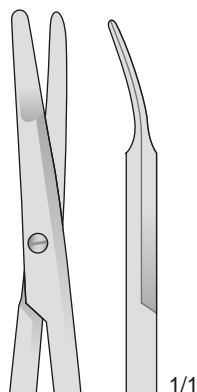

FG-67  
120 mm

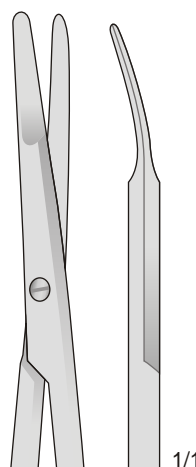

FG-19C  
135 mm

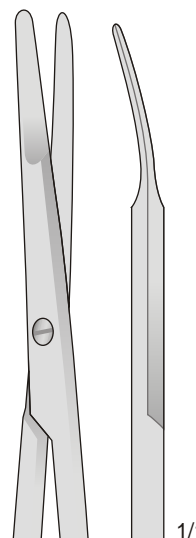

FG-6C  
150 mm

Gezahnt - Saw edge - Dentellate  
Dentadas - Dentelés

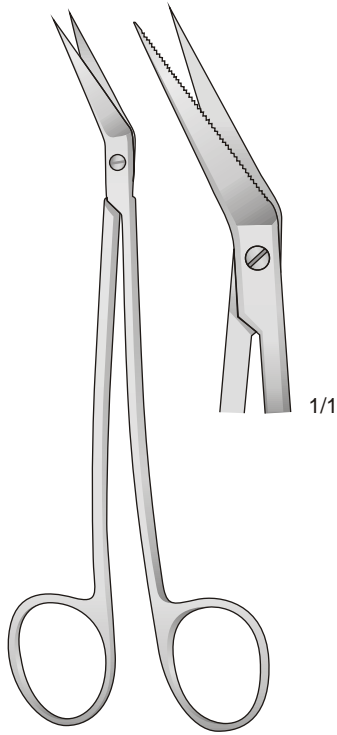

**LOCKLIN  
LK-2**  
160 mm

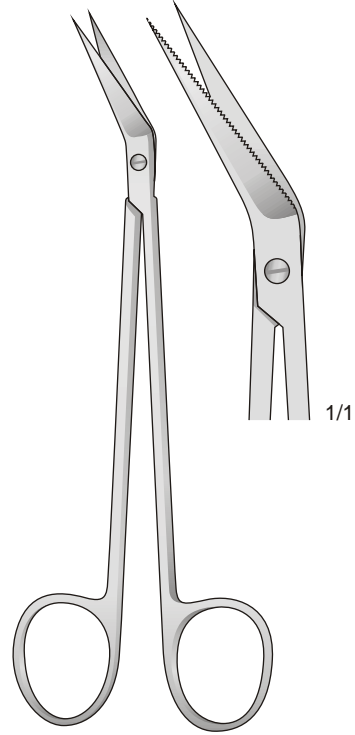

**LOCKLIN  
LK-4**  
160 mm

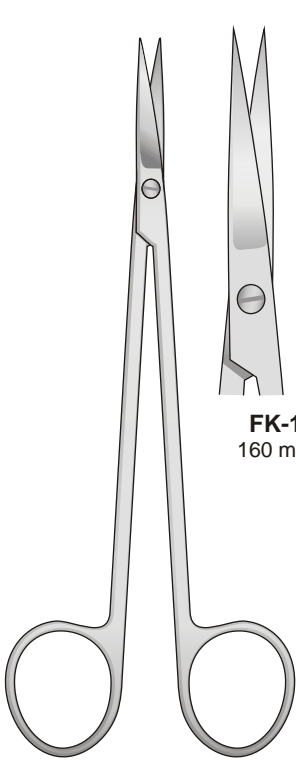

**KELLY  
FK-1/FK-87**

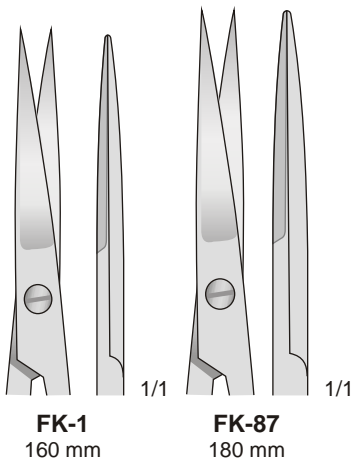

**FK-1**  
160 mm

**FK-87**  
180 mm

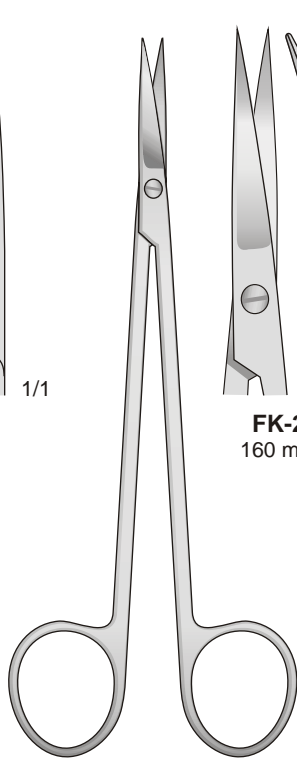

**KELLY  
FK-2/FK-88**

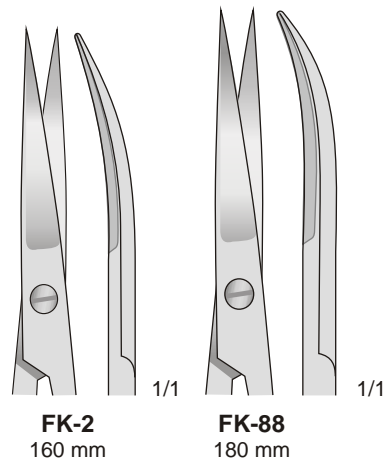

**FK-2**  
160 mm

**FK-88**  
180 mm

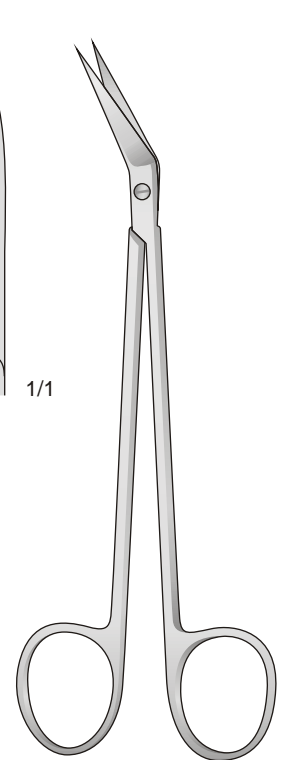

**KELLY  
FK-10**  
160 mm



Standard

Stumpf - Blunt  
Smusse - Romas  
Mousses

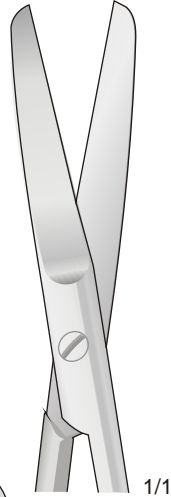
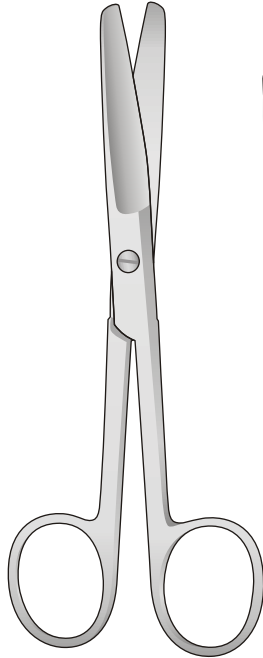

1/1

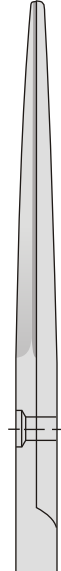

1/1

**FM-35**  
130 mm

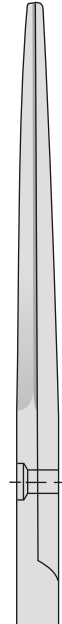

1/1

**FM-9**  
145 mm

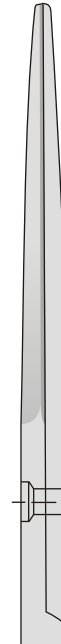

1/1

**FM-37**  
165 mm

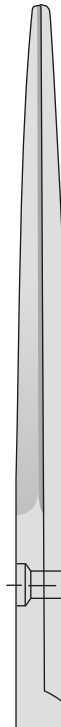

1/1

**FM-39**  
185 mm

**FM-9/FM-39**

Stumpf - Blunt  
Smusse - Romas  
Mousses

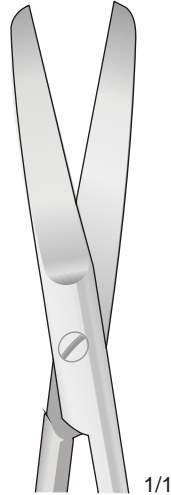
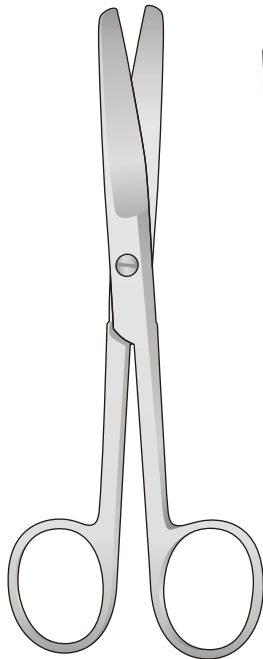

1/1



1/1

**FM-36**  
130 mm



1/1

**FM-10**  
145 mm



1/1

**FM-38**  
165 mm



1/1

**FM-40**  
185 mm

**FM-10/FM-40**

Standard

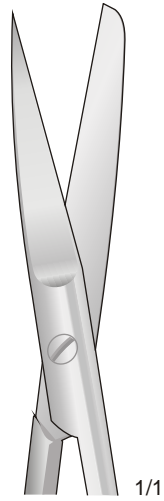
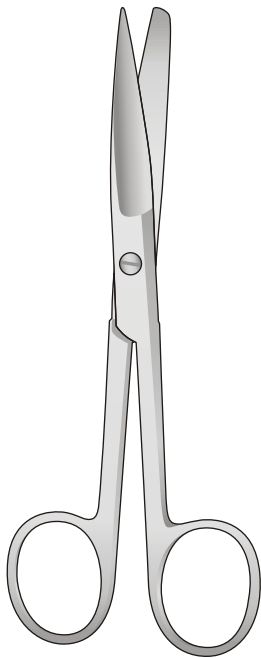

1/1

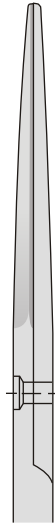

1/1

**FM-49**  
115 mm



1/1

**FM-27**  
130 mm

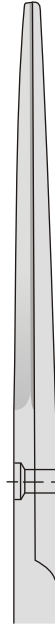

1/1

**FM-29**  
145 mm

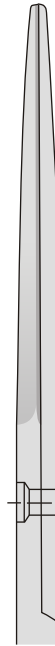

1/1

**FM-31**  
165 mm

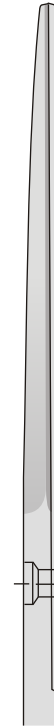

1/1

**FM-33**  
185 mm

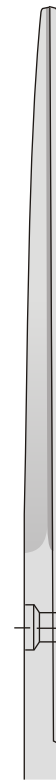

1/1

**FM-62**  
200 mm

FM-27/FM-62

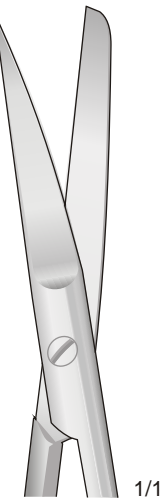
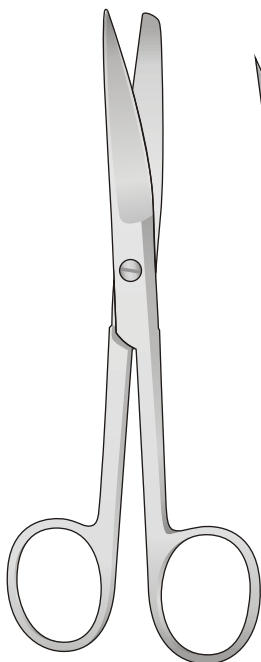

1/1



1/1

**FM-63**  
115 mm



1/1

**FM-28**  
130 mm



1/1

**FM-30**  
145 mm



1/1

**FM-32**  
165 mm



1/1

**FM-34**  
185 mm

FM-28/FM-63

Standard

Spitz - Sharp  
Acuta - Agudo - Pointu

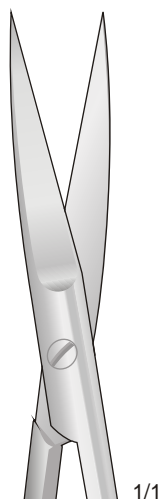
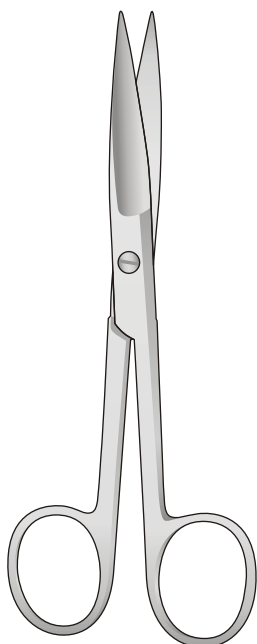

1/1

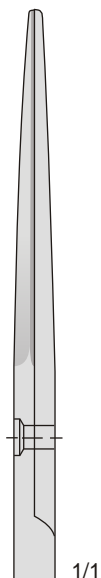

1/1

**FM-41**  
130 mm

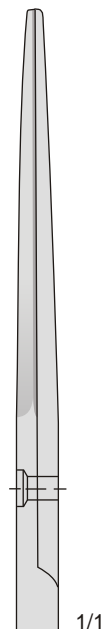

1/1

**FM-7**  
145 mm

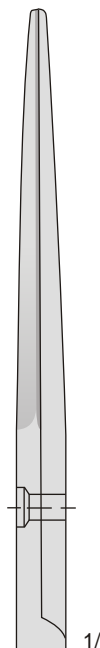

1/1

**FM-43**  
165 mm

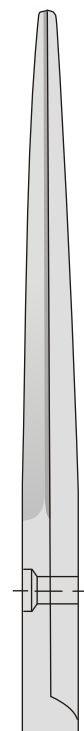

1/1

**FM-45**  
185 mm

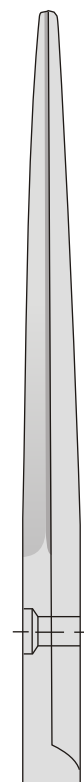

1/1

**FM-72**  
200 mm

**FM-7/FM-72**

Spitz - Sharp  
Acuta - Agudo - Pointu

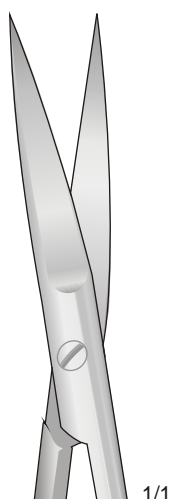
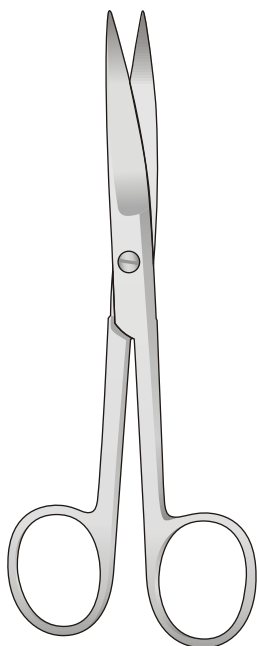

1/1

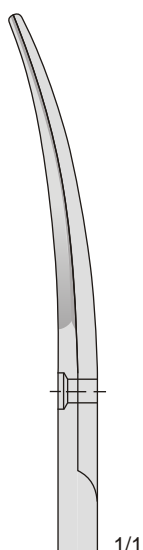

1/1

**FM-42**  
130 mm

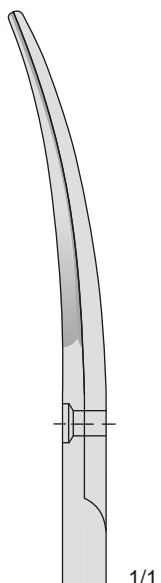

1/1

**FM-8**  
145 mm



1/1

**FM-44**  
165 mm

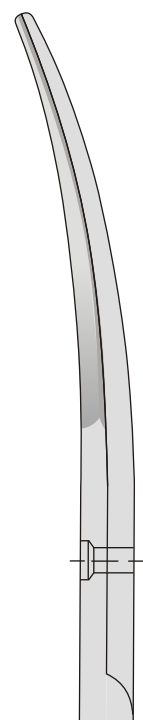

1/1

**FM-46**  
185 mm

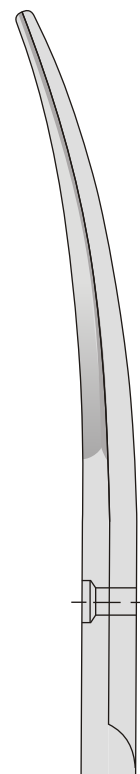

1/1

**FM-73**  
200 mm

**FM-8/FM-73**

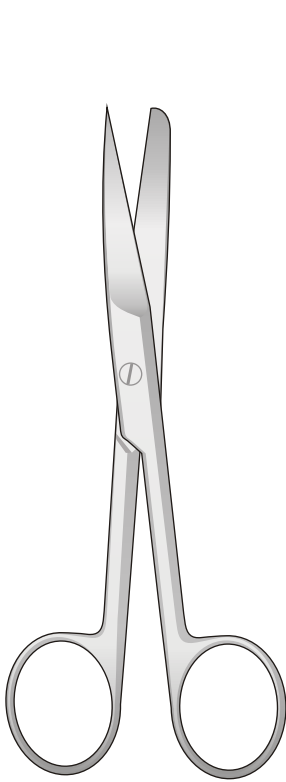

DEAVER  
**FG-47/FG-49**  
145 mm

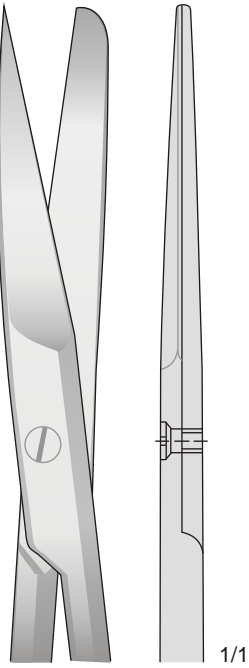

**FG-47**  
145 mm

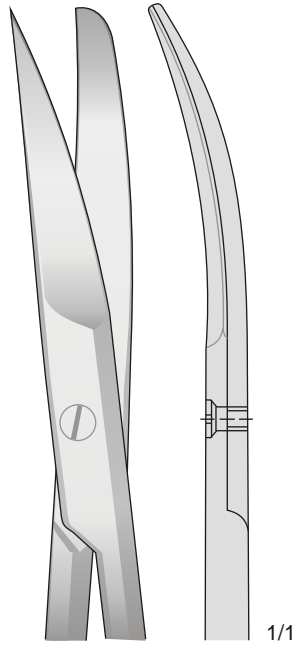

**FG-48**  
145 mm

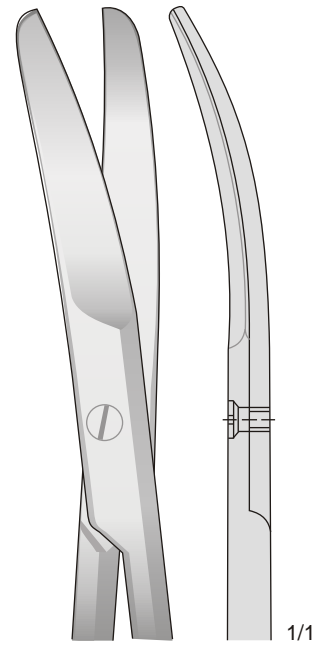

**FG-49**  
145 mm

Inzisionscheren - Incision scissors  
Forbici da incisione - Tijeras para incisión  
Ciseaux à incision

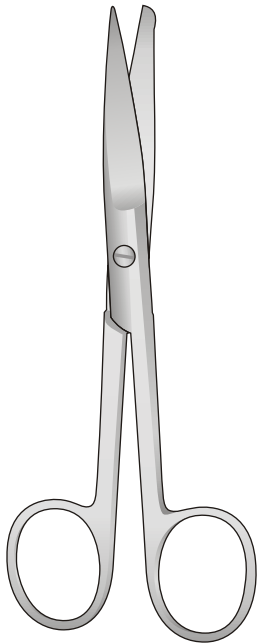

**FG-16/FG-117**

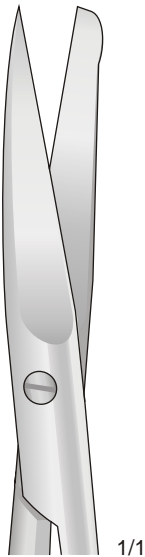

**FG-16**  
130 mm

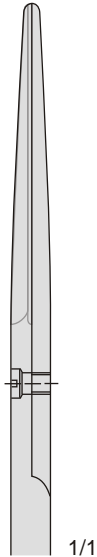

**FG-17**  
145 mm

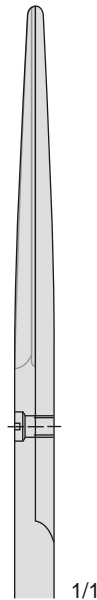

**FG-117**  
165 mm

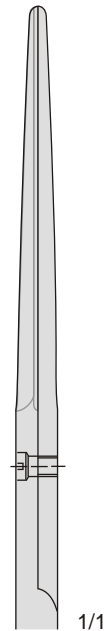

**FG-18**  
185 mm

Chirurgische Scheren

Operating Scissors

Forbici chirurgiche

Tijeras para cirugía

Ciseaux chirurgicaux

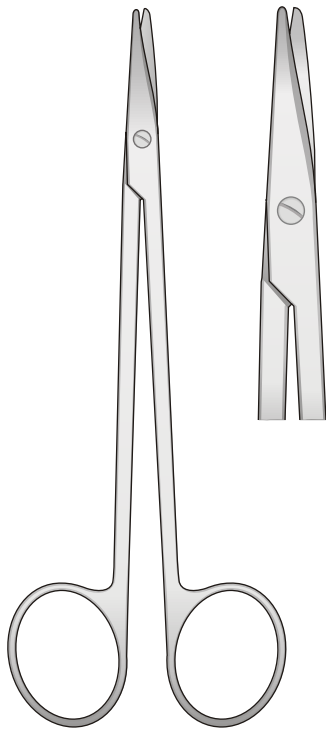

**METZENBAUM**  
**FM-12/FM-109**  
150 mm

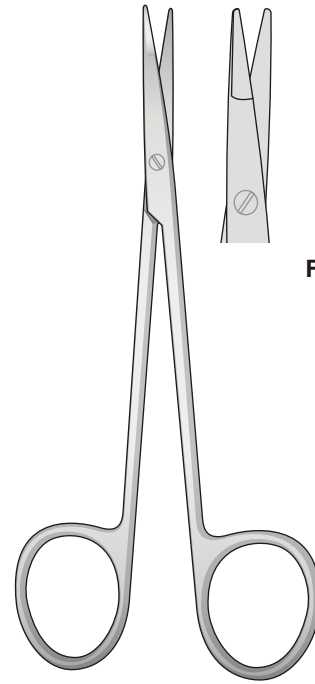
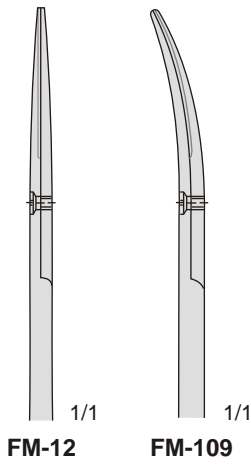

**SHEA**  
**FG-90/FG-91**  
120 mm

Spitz - Sharp  
Acuta - Agudo - Pointu

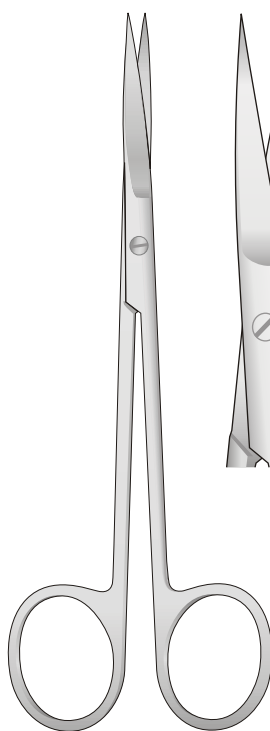

**JOSEPH**  
**FG-147/FG-148**  
150 mm

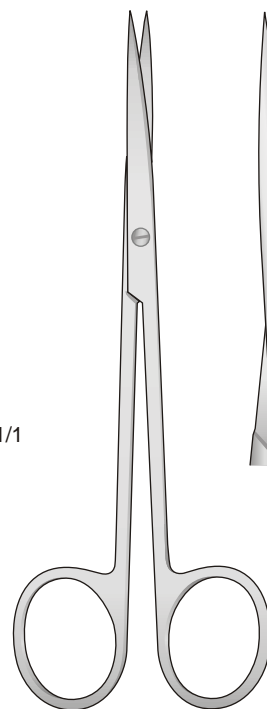
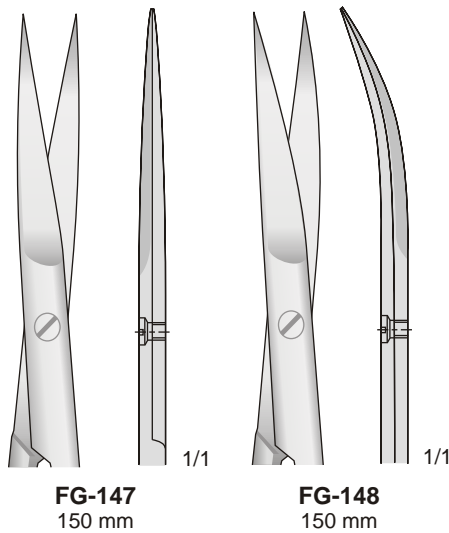

**METZENBAUM**  
**FM-126/FM-127**  
145 mm

Feine Scheren

Delicate scissors

Forbici delicate

Tijeras finas

Ciseaux délicate

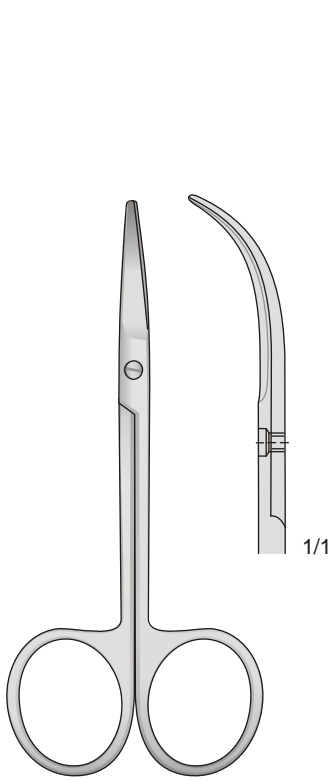

**FOMON  
FG-43**  
110 mm

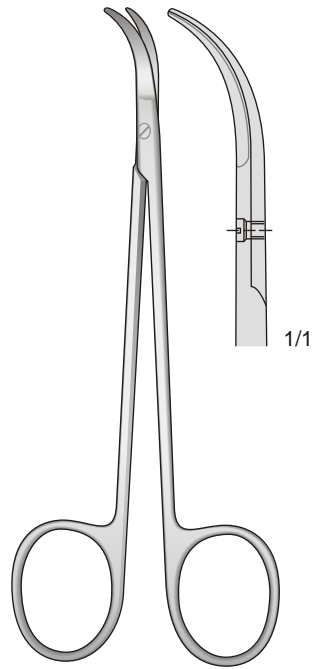

**FOMON  
FG-93**  
135 mm

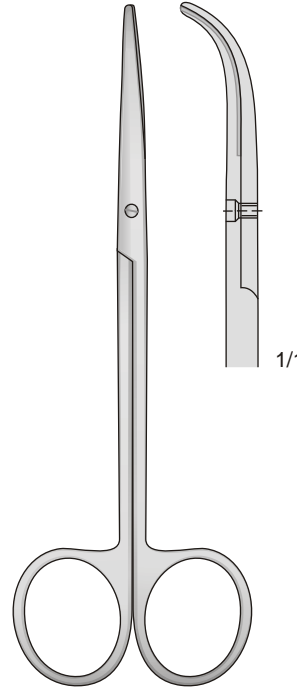

**FOMON  
FG-44**  
140 mm

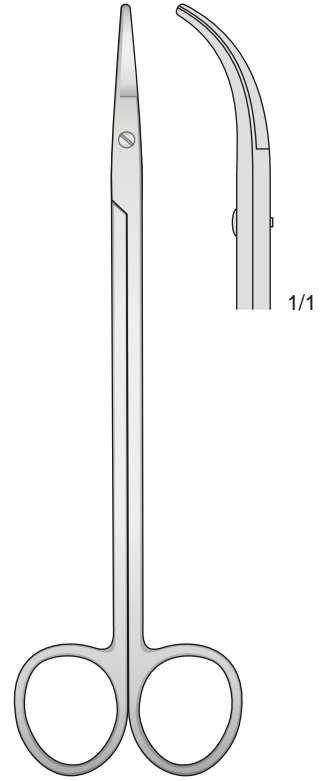

**WALTON  
FG-146**  
165 mm

Mit Fadenbohrung - With eye for suture  
Con occhiello per sutura - Tijeras para ligaduras  
Avec oeil pour les sutures

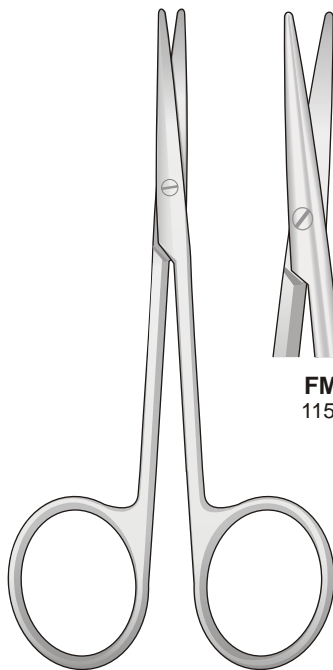

**BABY - METZENBAUM  
FM-47/FM-48**  
115 mm

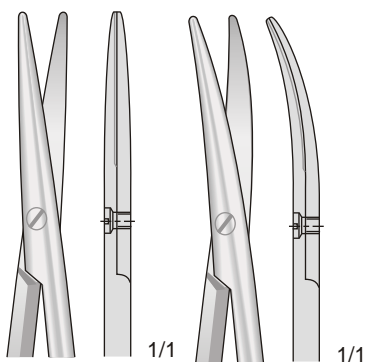

**FM-47**  
115 mm

**FM-48**  
115 mm

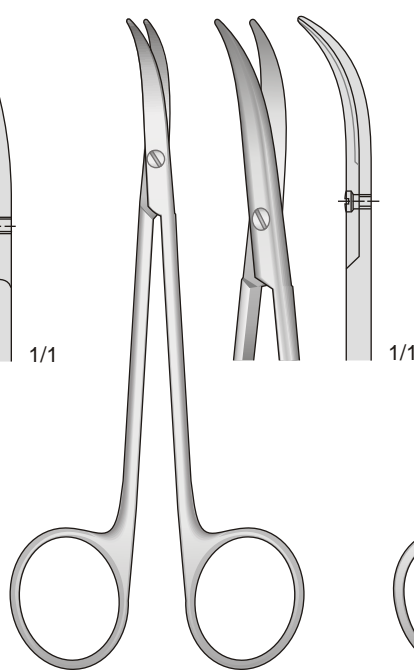

**CINELLI  
FG-95**  
115 mm

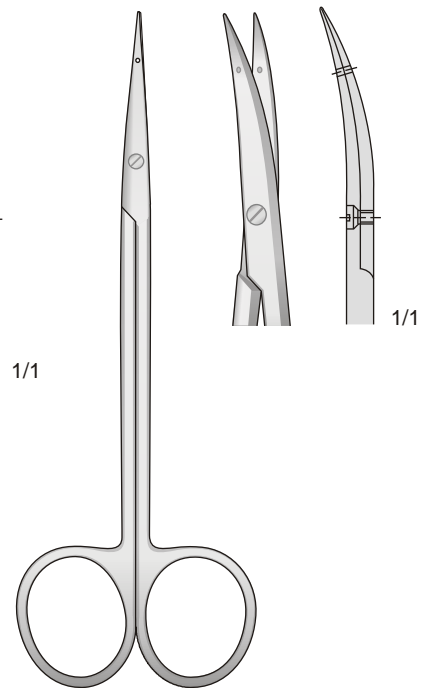

**LITTLER  
FG-100**  
120 mm

Präparierscheren - Dissecting Scissors  
 Forbici per dissezione - Tijeras para preparaciones - Ciseaux à dissection

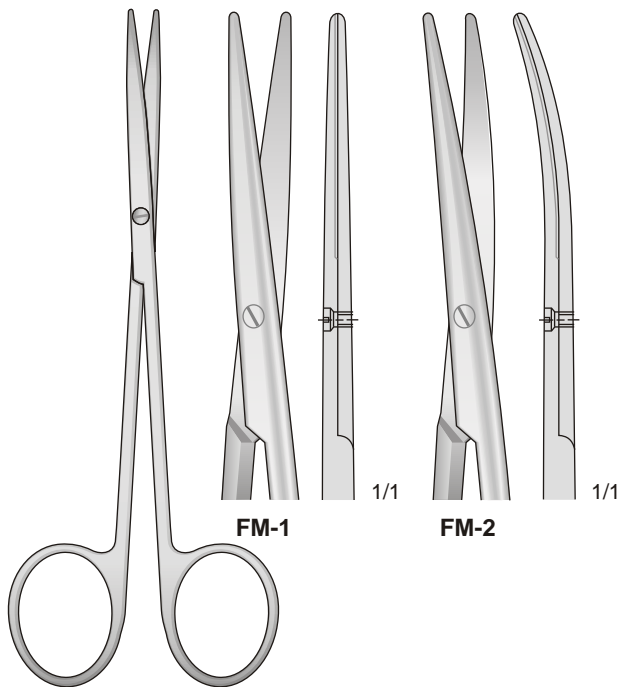

**METZENBAUM**  
**FM-1/FM-2**  
 145 mm

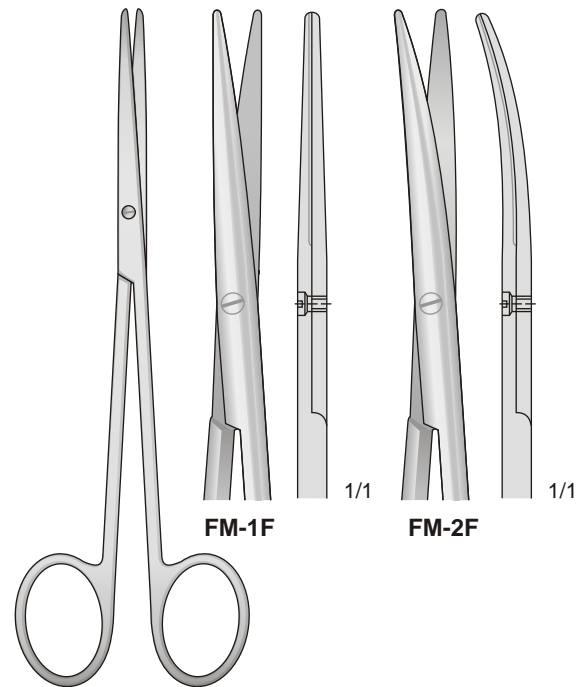

**METZENBAUM-FINO**  
**FM-1F/FM-2F**  
 145 mm

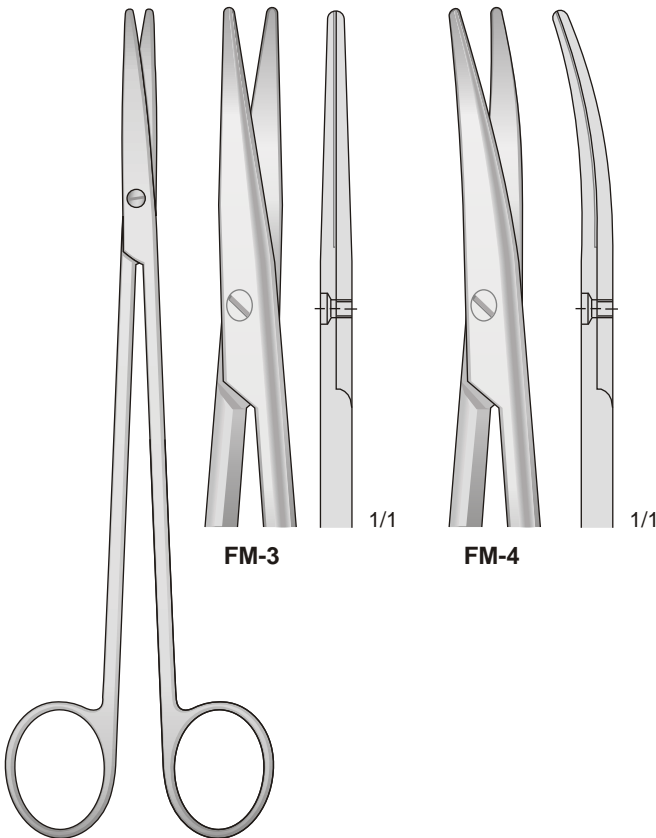

**METZENBAUM**  
**FM-3/FM-4**  
 185 mm

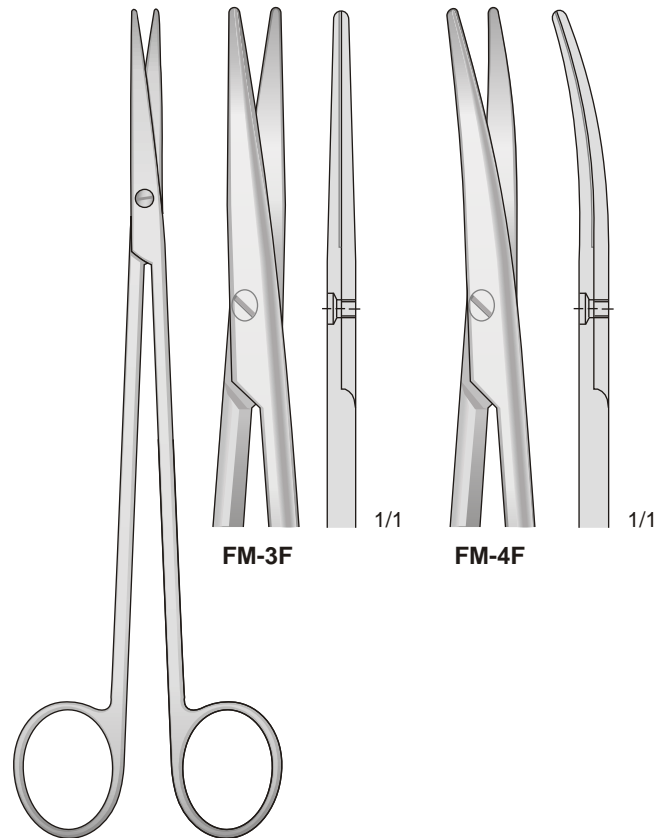

**METZENBAUM-FINO**  
**FM-3F/FM-4F**  
 185 mm

Präparierscheren - Dissecting Scissors  
 Forbici per dissezione - Tijeras para preparaciones - Ciseaux à dissection

Spitz - Sharp  
 Acuta - Agudo - Pointu

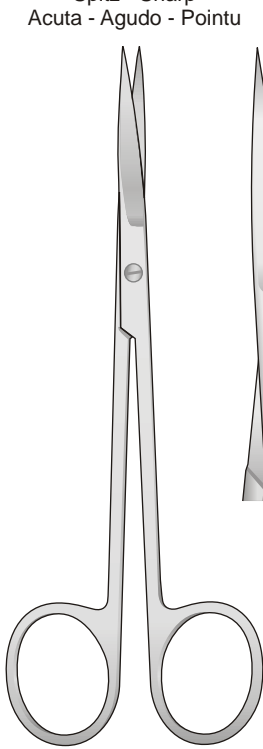

**METZENBAUM  
 FG-14/FG-28**  
 145 mm

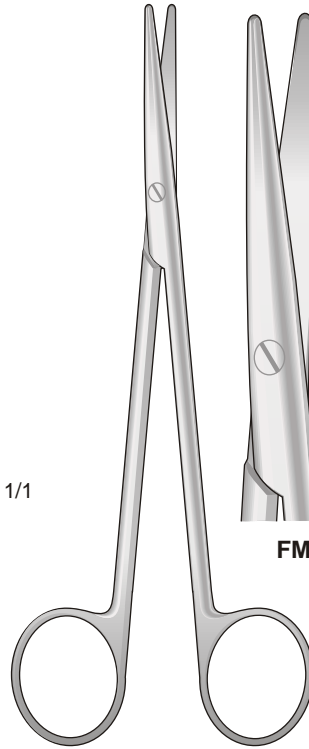
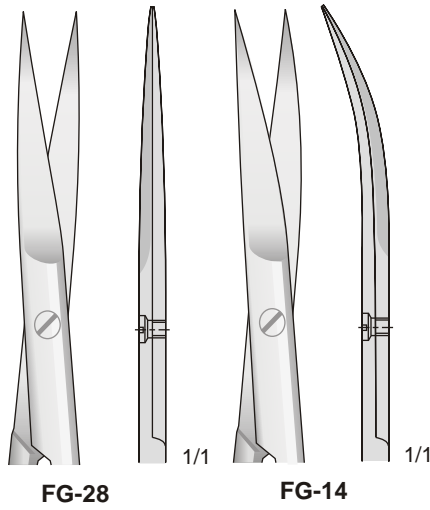

**METZENBAUM  
 FM-74/FM-75**  
 160 mm

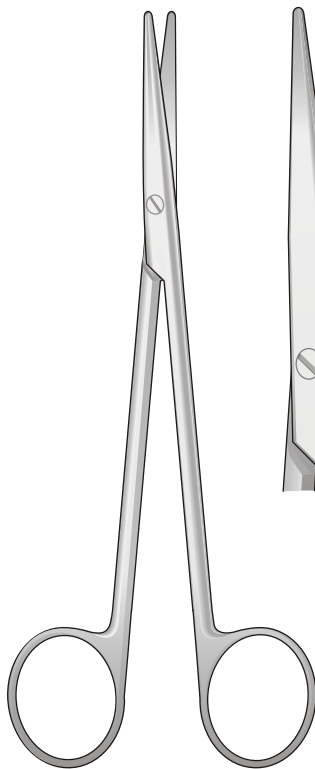
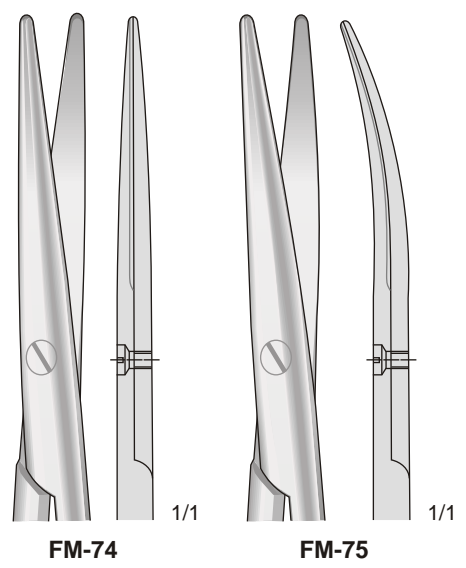

**METZENBAUM  
 FM-70/FM-71**  
 200 mm

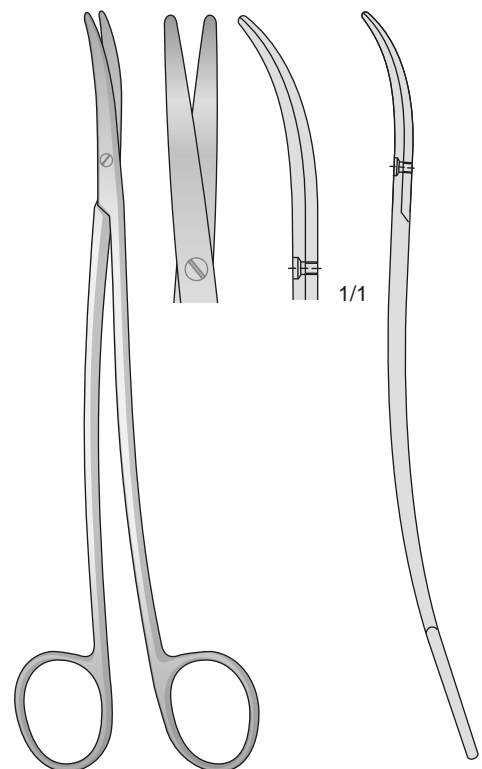
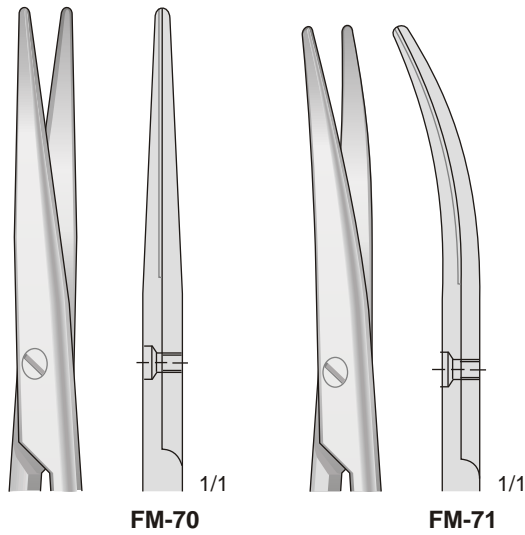

**METZENBAUM-FINO**  
**FM-120** - 180 mm  
**FM-121** - 200 mm  
**FM-122** - 230 mm



Chirurgische Scheren

Operating Scissors

Forbici chirurgiche

Tijeras para cirugía

Ciseaux chirurgicaux

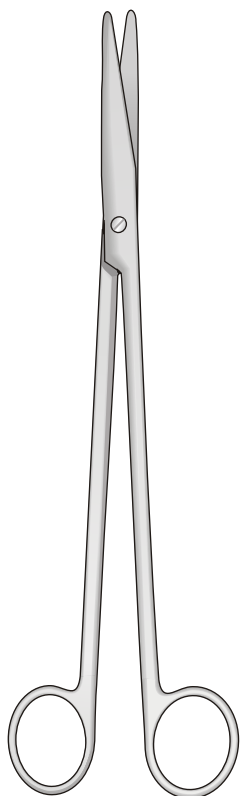

NELSON-METZENBAUM  
FM-11/FM-114

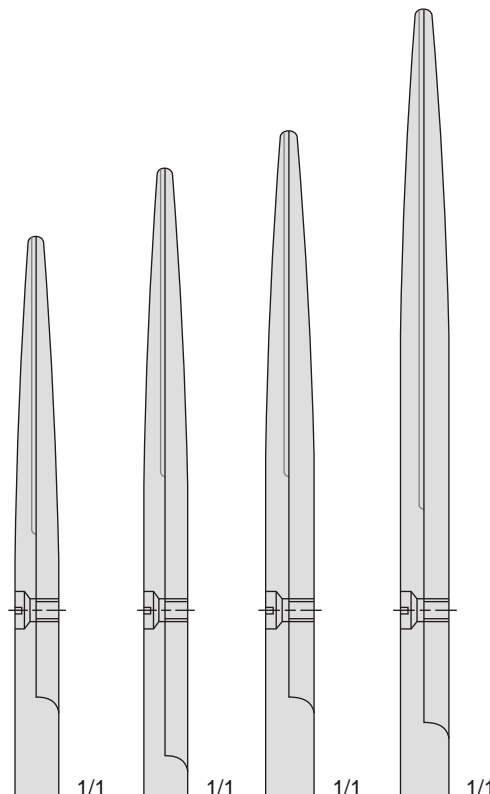
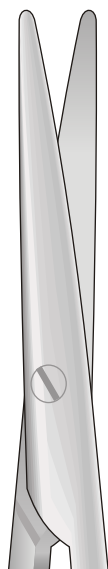

**FM-11** 230 mm  
**FM-112** 250 mm  
**FM-113** 280 mm  
**FM-114** 305 mm

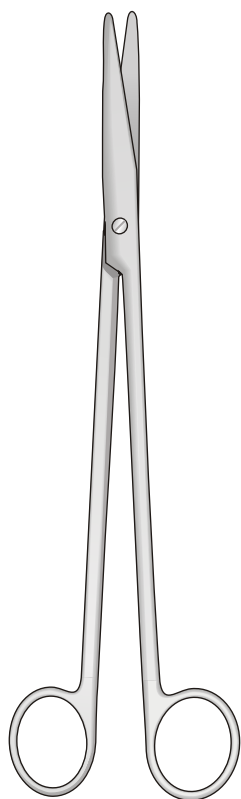

NELSON-METZENBAUM  
FM-13/FM-117

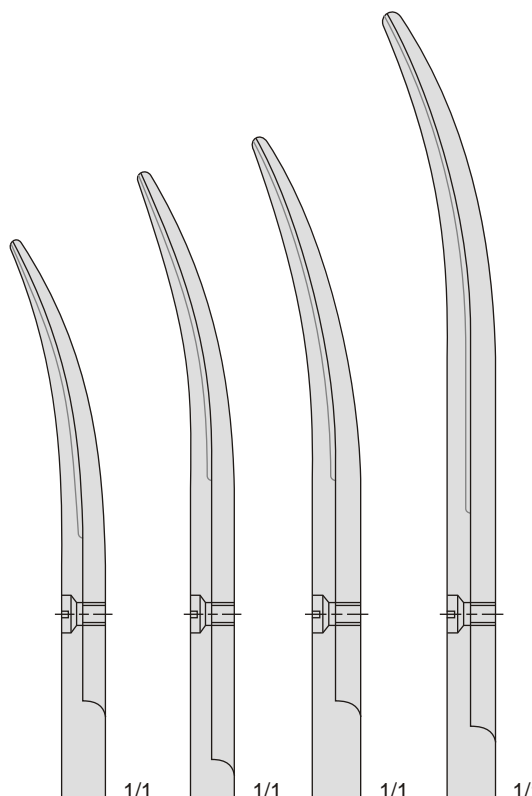
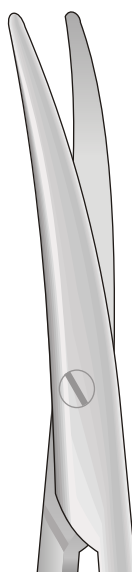

**FM-13** 230 mm  
**FM-115** 250 mm  
**FM-116** 280 mm  
**FM-117** 305 mm

Fein - Delicate - Fine - Finas - Fins

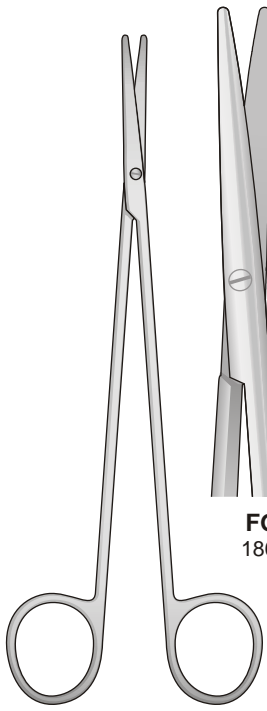

**TOENNIS-ADSON**  
**FG-60/FG-61**  
180 mm

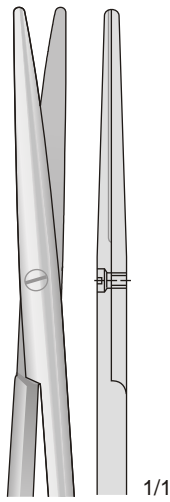

**FG-60**  
180 mm

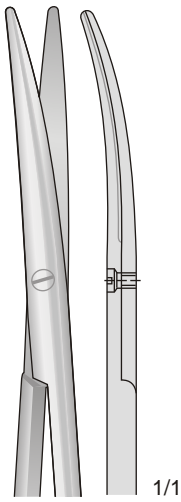

**FG-61**  
180 mm

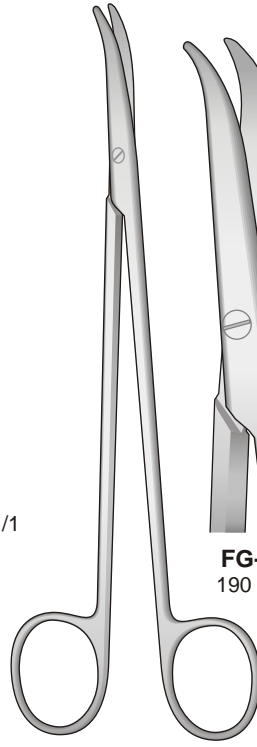

**THOREK**  
**FG-45/FG-65**

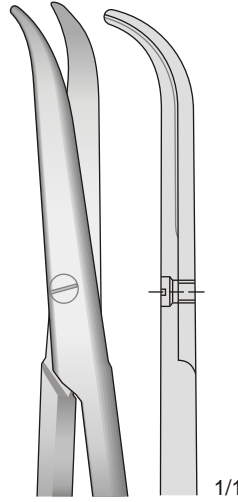

**FG-45**  
190 mm

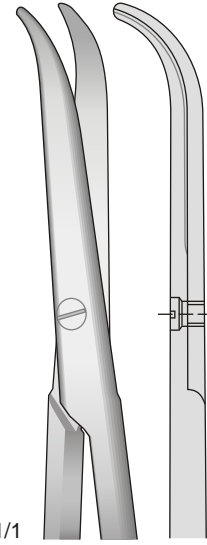

**FG-46**  
230 mm

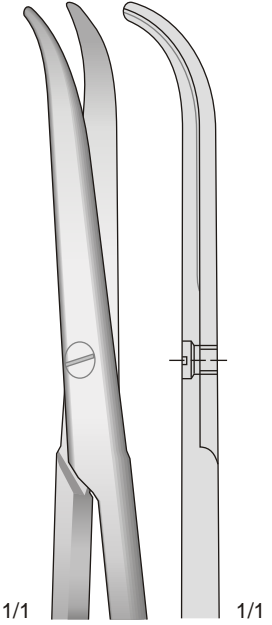

**FG-65**  
250 mm

Fein - Delicate - Fine - Finas - Fins

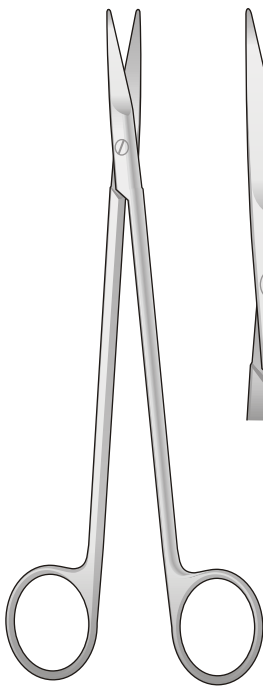

**TOENNIS**  
**FG-73/FG-75**  
180 mm

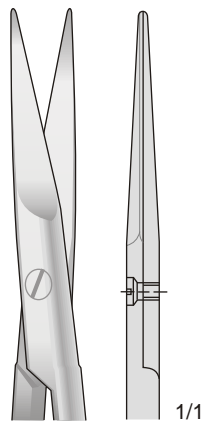

**FG-73**  
180 mm

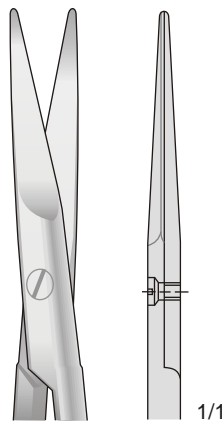

**FG-74**  
180 mm

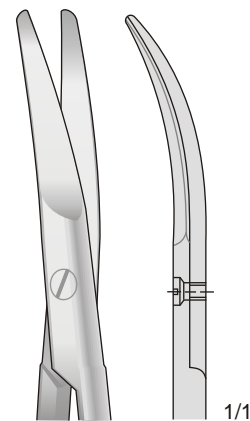

**FG-75**  
180 mm

Präparierscheren - Dissecting scissors - Forbici per dissezione - Tijeras para preparaciones - Ciseaux à dissection

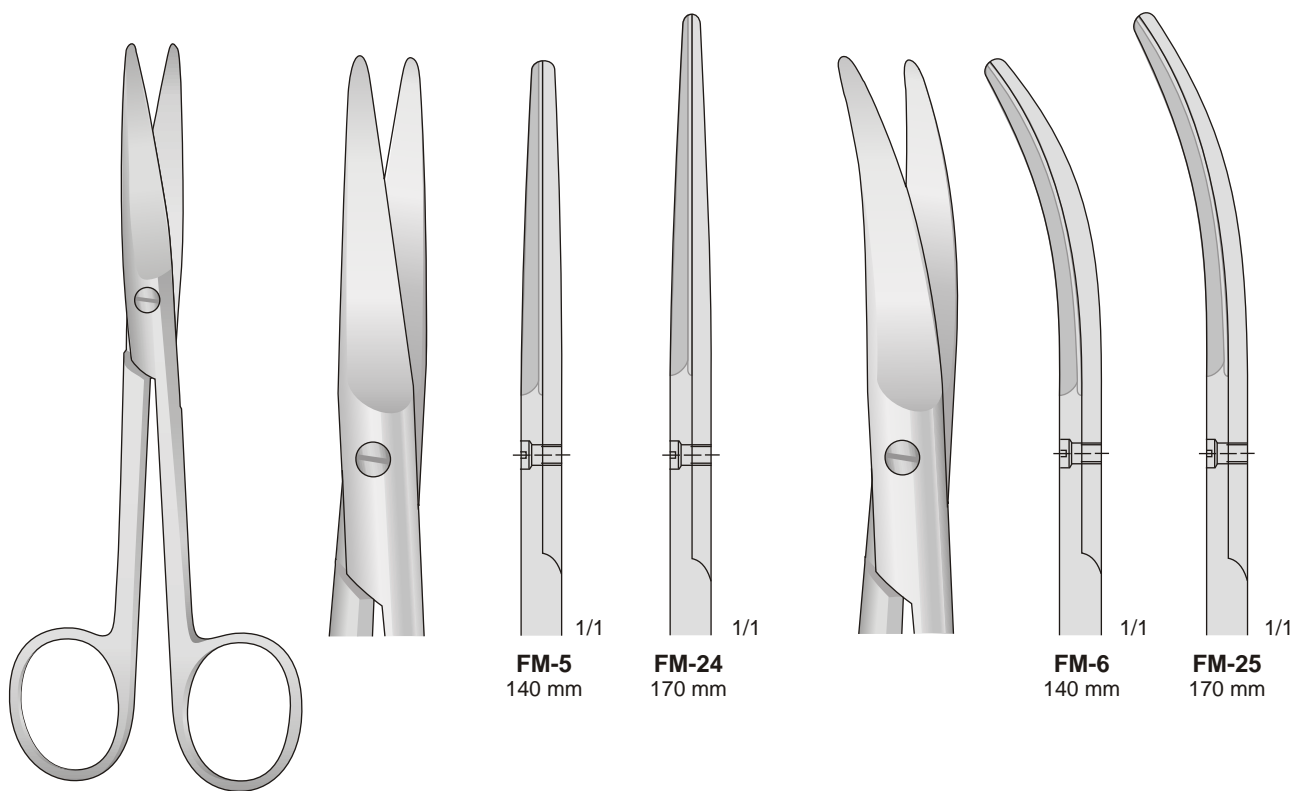

MAYO  
FM-5/FM-25

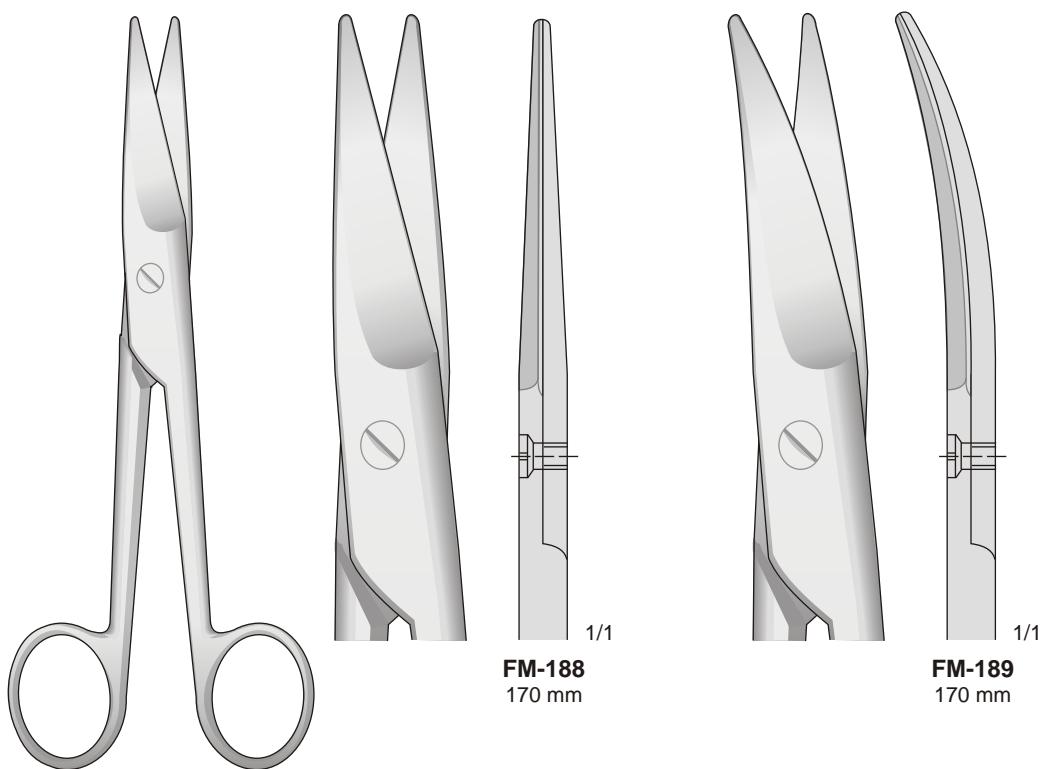

MAYO-NOBLE  
FM-188/FM-189

Präparierscheren - Dissecting scissors - Forbici per dissezione - Tijeras para preparaciones - Ciseaux à dissection

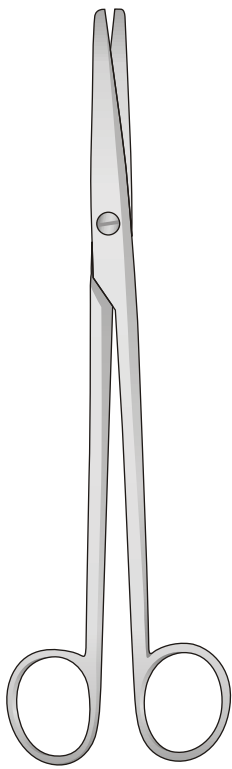

MAYO  
**FM-80/FM-82**

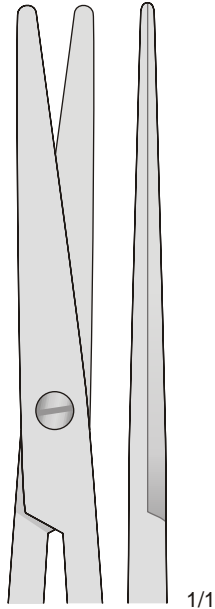

**FM-80**  
160 mm

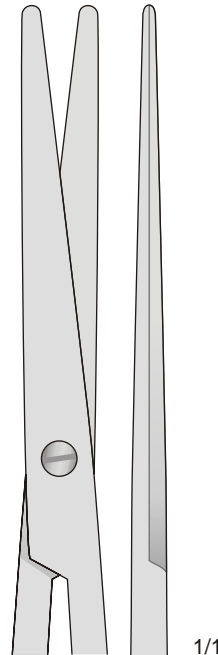

**FM-81**  
190 mm

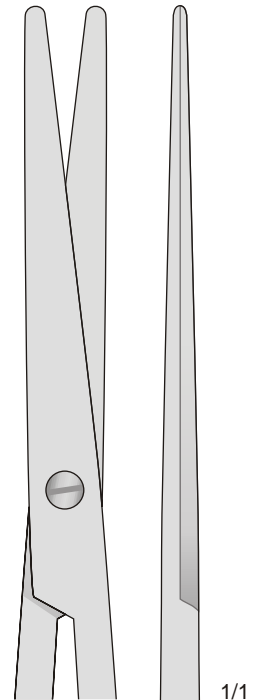

**FM-82**  
210 mm

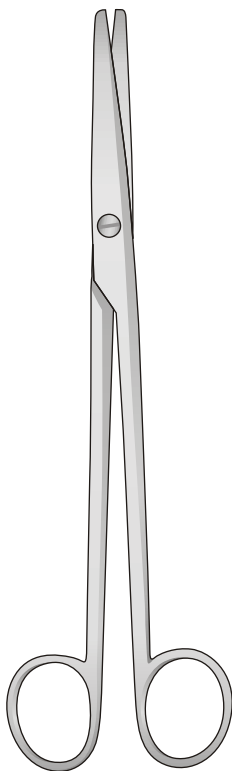

MAYO  
**FM-83/FM-85**

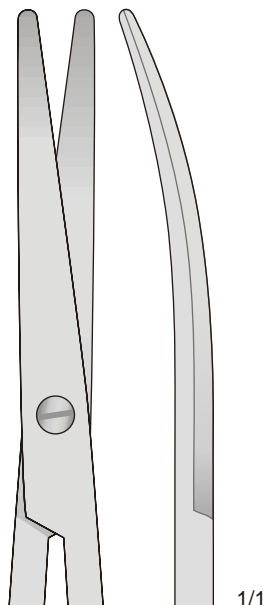

**FM-83**  
160 mm

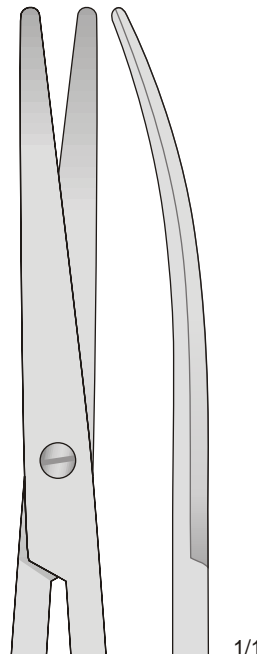

**FM-84**  
190 mm

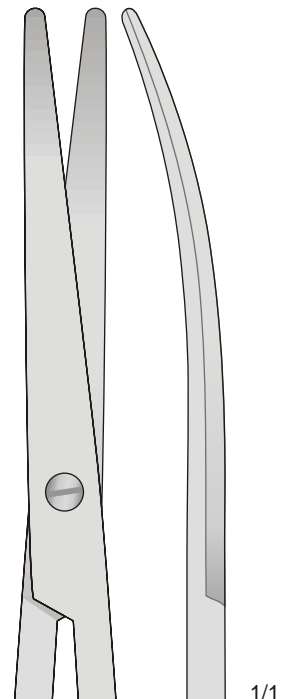

**FM-85**  
210 mm

Fein - Delicate - Fine - Finas - Fins

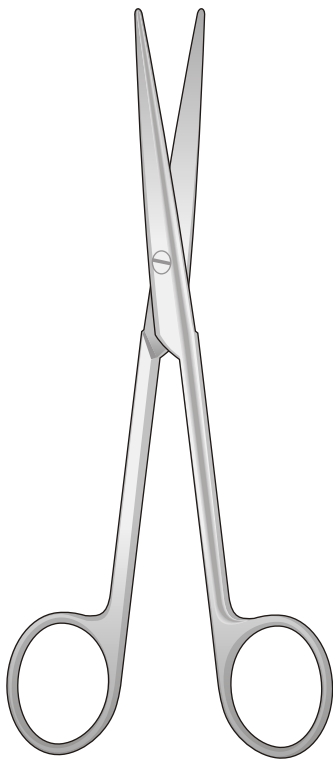

LEXER  
**FM-180/FM-181**  
165 mm

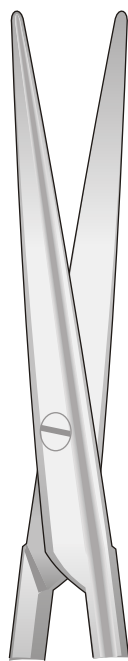

**FM-180**

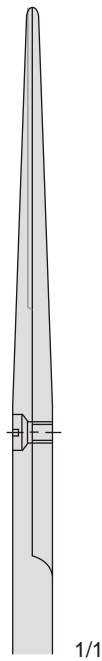

**FM-181**

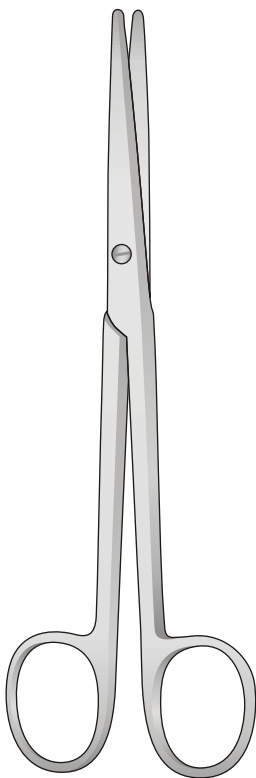
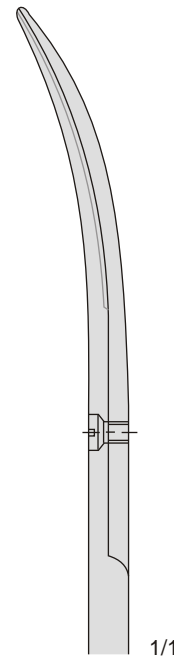

LEXER  
**FM-86/FM-89**

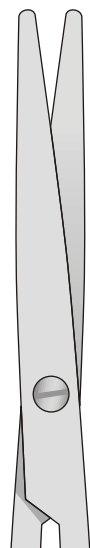

**FM-86**  
160 mm

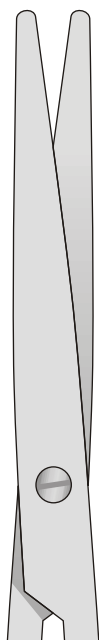
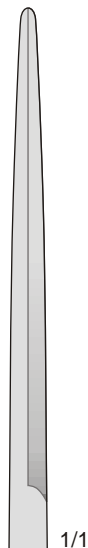

**FM-87**  
210 mm

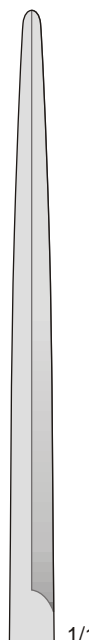

**FM-88**  
160 mm



**FM-89**  
210 mm

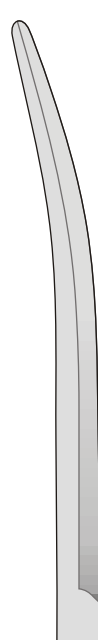

Präparierscheren - Dissecting Scissors - Forbici per dissezione - Tijeras para preparaciones - Ciseaux à dissection



**FM-110**  
150 mm

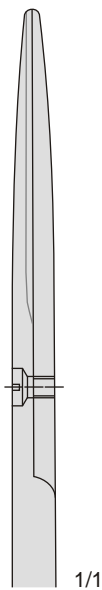

1/1



**FM-111**  
150 mm

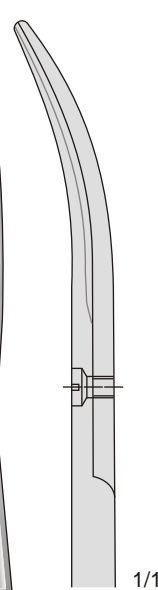

1/1

STILLE  
**FM-110/FM-111**  
150 mm

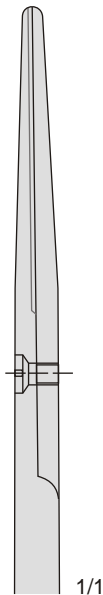
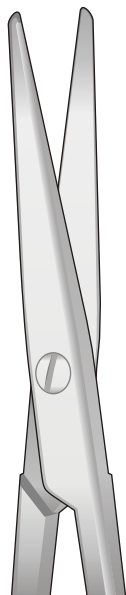
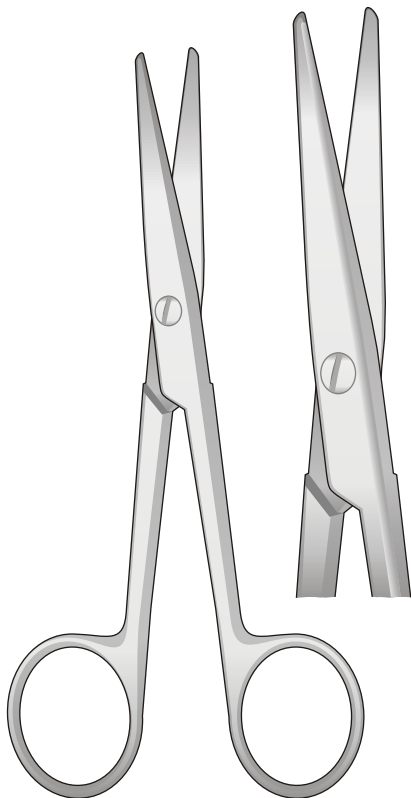

1/1

**FM-76**  
140 mm

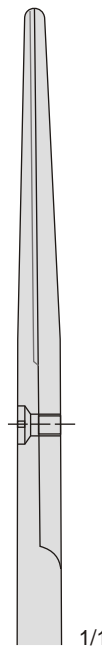

1/1

**FM-77**  
170 mm

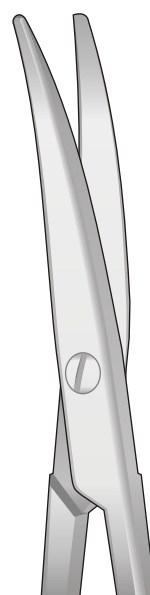

**FM-78**  
140 mm

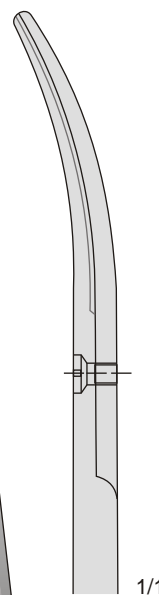

1/1

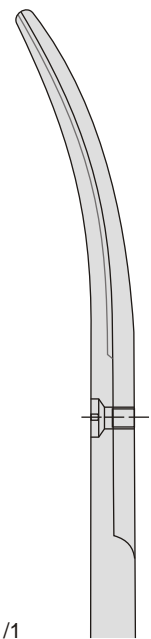

1/1

**FM-79**  
170 mm

MAYO-STILLE  
**FM-76/FM-79**

Chirurgische Scheren

Operating Scissors

Forbici chirurgiche

Tijeras para cirugía

Ciseaux chirurgicaux

Präparierscheren - Bilateral Dissecting Scissors  
 Forbici per dissezione a taglio bilaterale - Tijeras para preparaciones - Ciseaux à dissection

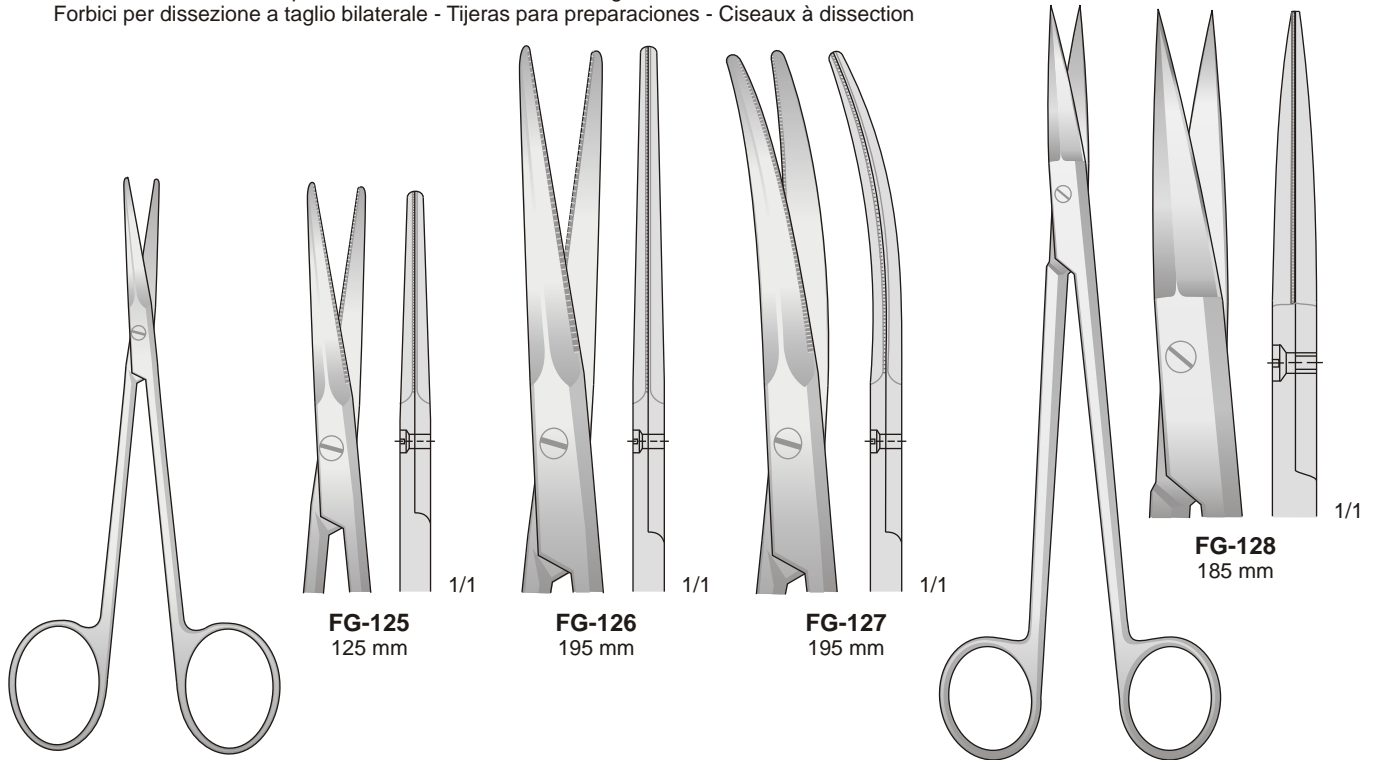

GORNEY  
 FG-125/FG-127

FG-128  
 185 mm

Präparierscheren - Bilateral Dissecting Scissors  
 Forbici per dissezione a taglio bilaterale - Tijeras para preparaciones - Ciseaux à dissection

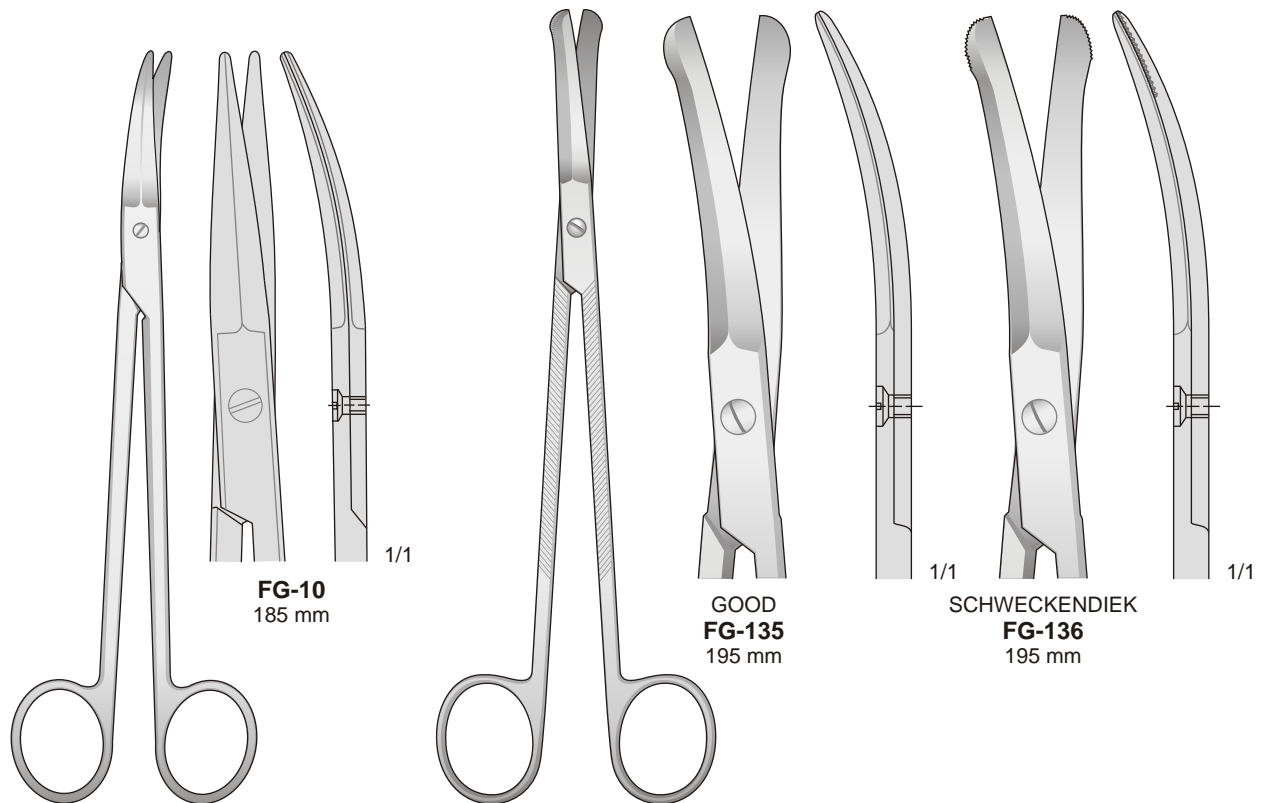

FG-10  
 185 mm

GOOD  
 FG-135  
 195 mm

SCHWECKENDIEK  
 FG-136  
 195 mm

Mit einer Schneide gezahnt - With one blade serrated  
 Con una lama dentellata - Con una hoja dentada  
 Avec une lame dentèle

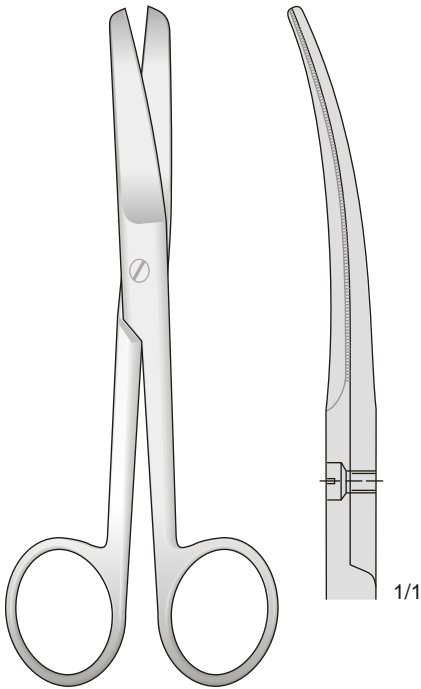

**FG-116**  
165 mm

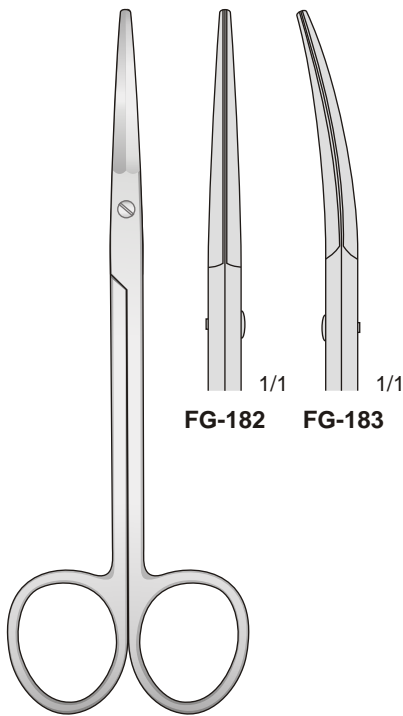

**KAHN**  
**FG-182/FG-183**  
145 mm

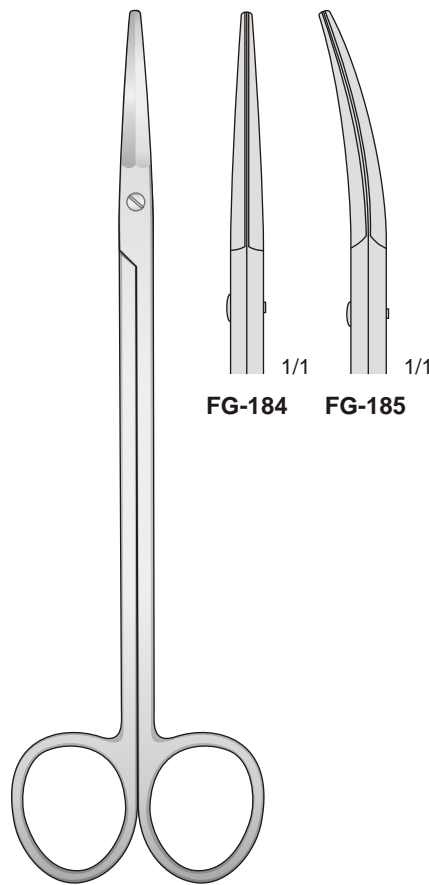

**KAHN**  
**FG-184/FG-185**  
180 mm

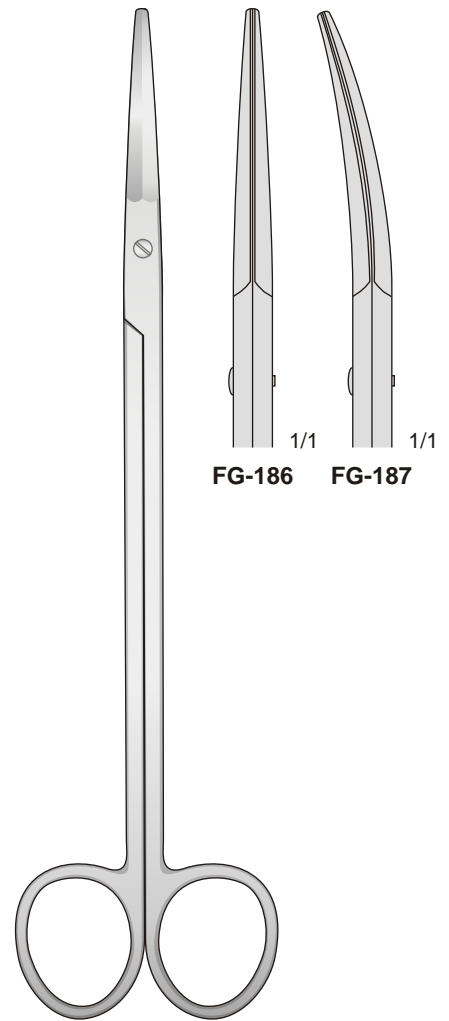

**KAHN**  
**FG-186/FG-187**  
205 mm



Gezahnt - Serrated - Dentellata - Dentadas - Dentelé

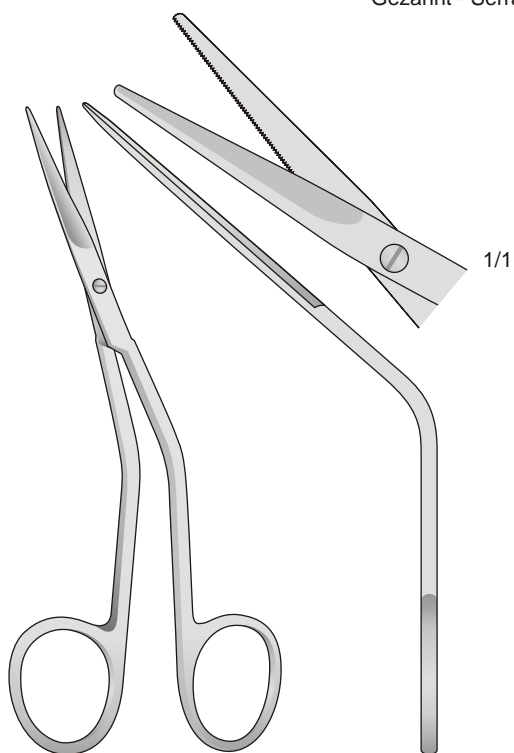

FOMON  
**FG-41**  
135 mm

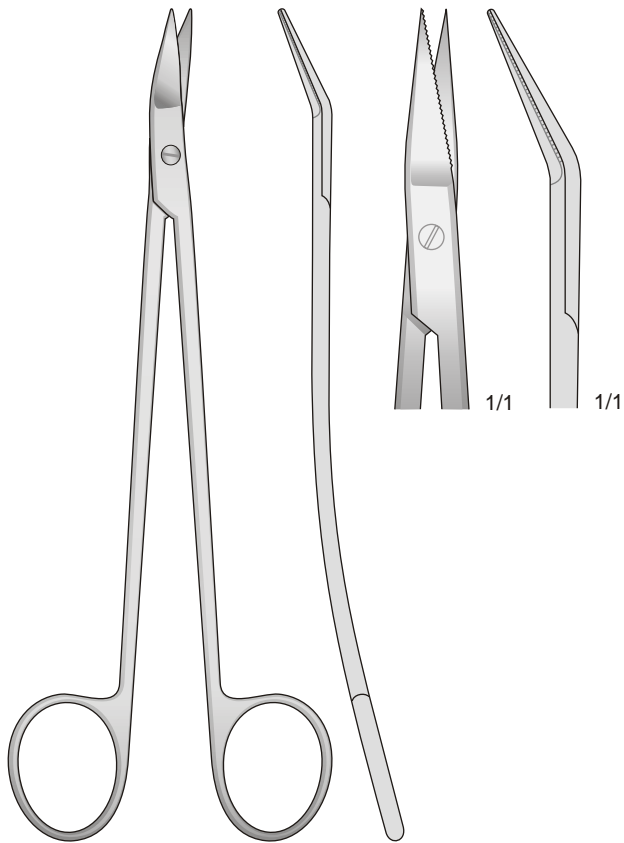

DEAN  
**DEAN**  
180 mm

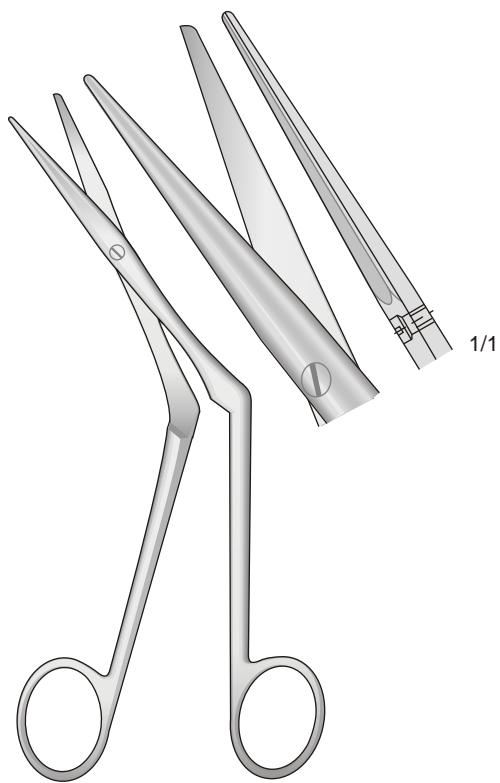

HEYMANN-KNIGHT  
**FG-99**  
175 mm

Nasenscheren - Nasal Scissors - Forbici nasali - Tijeras nasales - Ciseaux nasaux

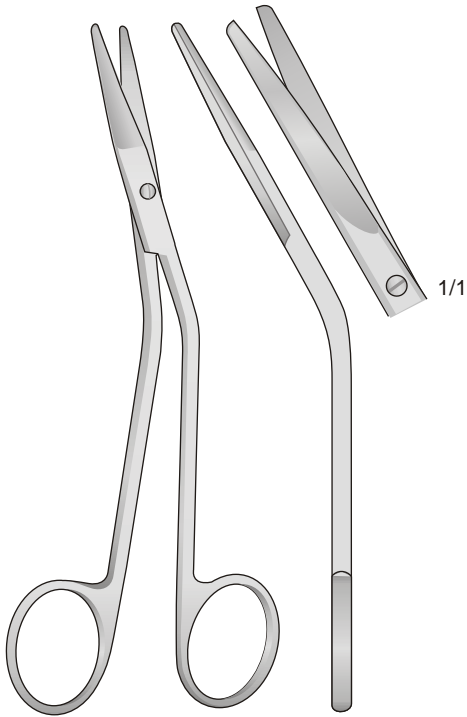

FOMON  
**FG-7**  
150 mm



HEYMANN  
**FG-8**  
180 mm

Gezahnt  
Serrated  
Dentellata  
Dentadas  
Dentelé

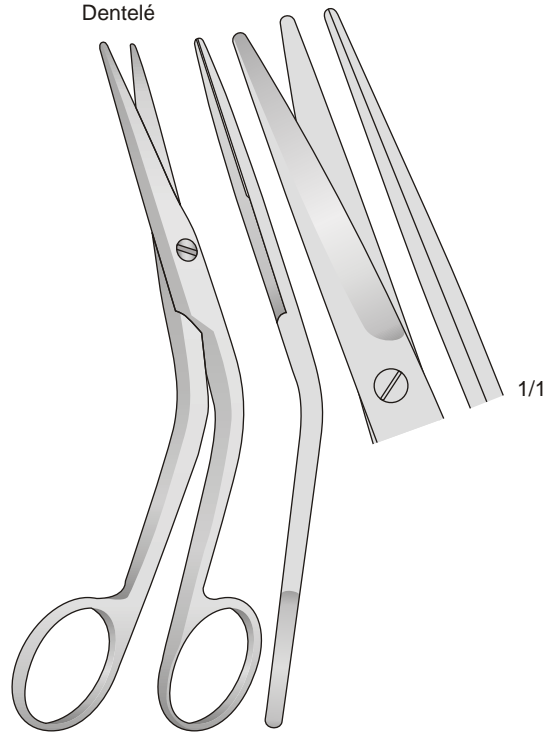

COTTLE  
**FG-9**  
160 mm

Knochensplitterscheren

Bone cutting scissors

Forbici ossivore

Tijeras para huesos

Ciseaux à os

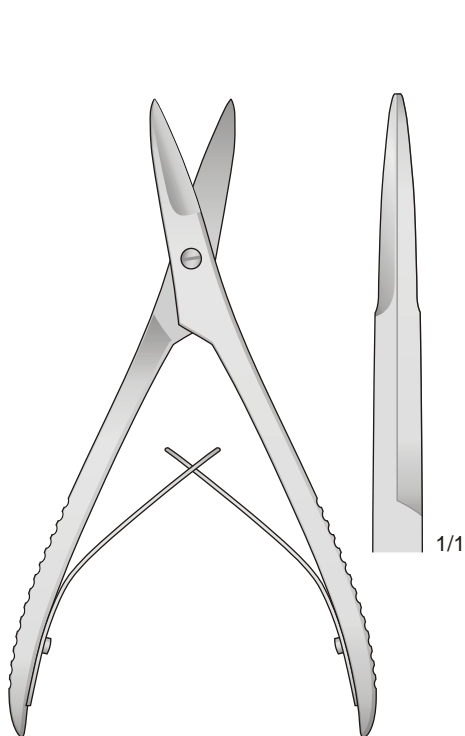

**FO-63**  
160 mm

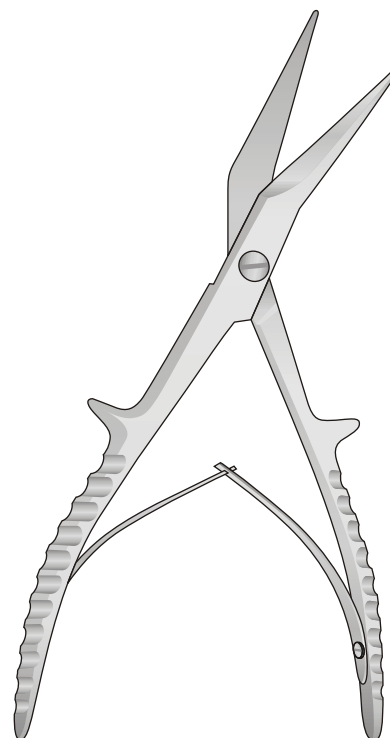

**FG-110**  
195 mm

Gezahnt  
Serrated  
Dentellata  
Dentadas  
Dentelé

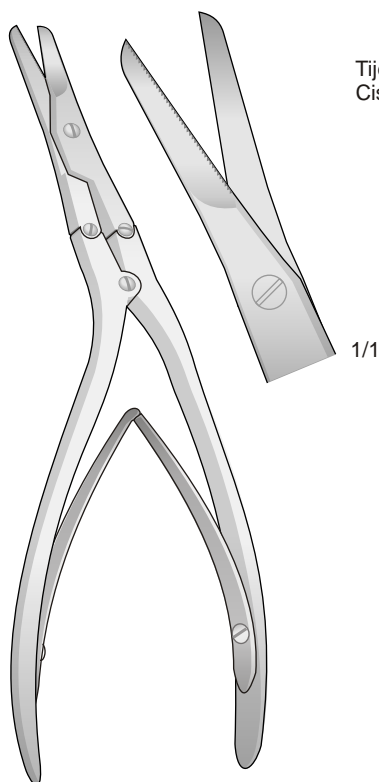

**CAPLAN**  
**FO-144**  
200 mm

Nasenseptumscheren  
Septum Scissors  
Forbici per setto nasale  
Tijeras para el tabique nasal  
Ciseaux pour cloison nasale

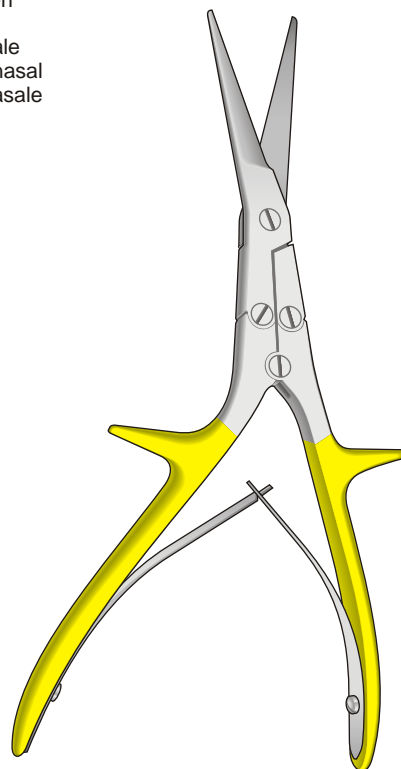

**GORNEY**  
**FO-190**  
205 mm

Mit einer Schneide gezahnt  
 With one blade serrated  
 Con una lama dentellata  
 Con una hoja dentada  
 Avec une lame dentèle

Super Cut

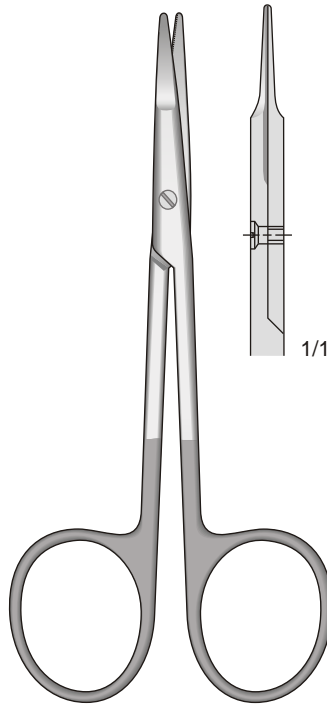

**GREENBERG-PAR**  
**FM-294**  
 115 mm

Super Cut

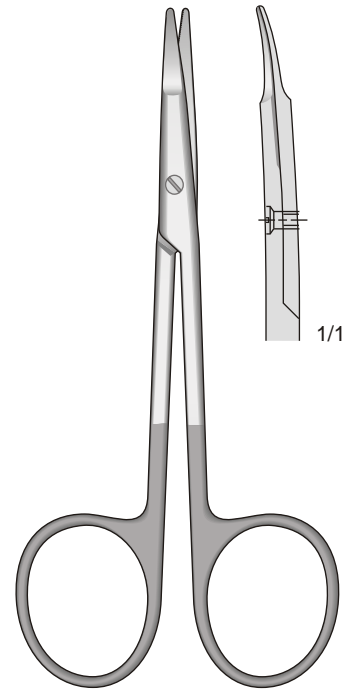

**GREENBERG-PAR**  
**FM-295**  
 115 mm

Super Cut

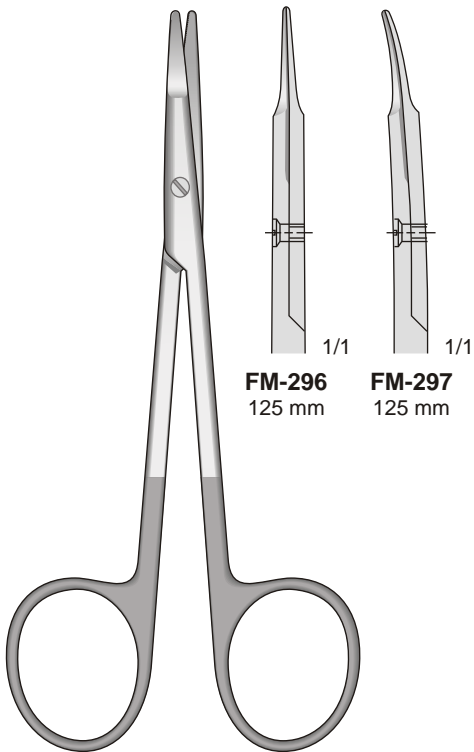

**KILNER**  
**FM-296/FM-297**  
 125 mm

Super Cut

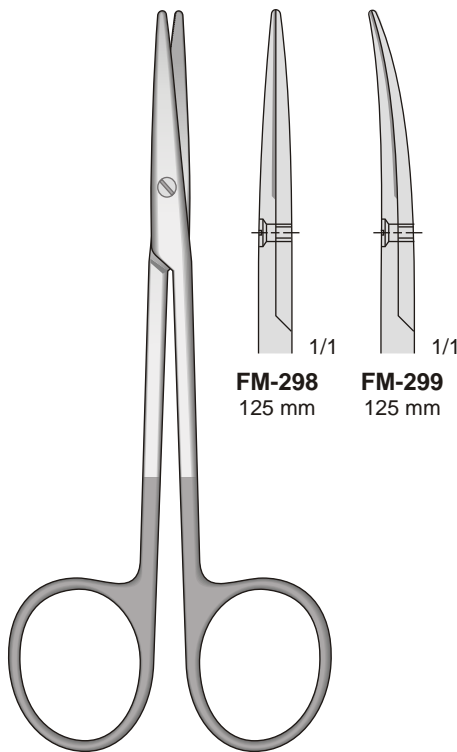

**METZENBAUM**  
**FM-298/FM-299**  
 125 mm

Super Cut

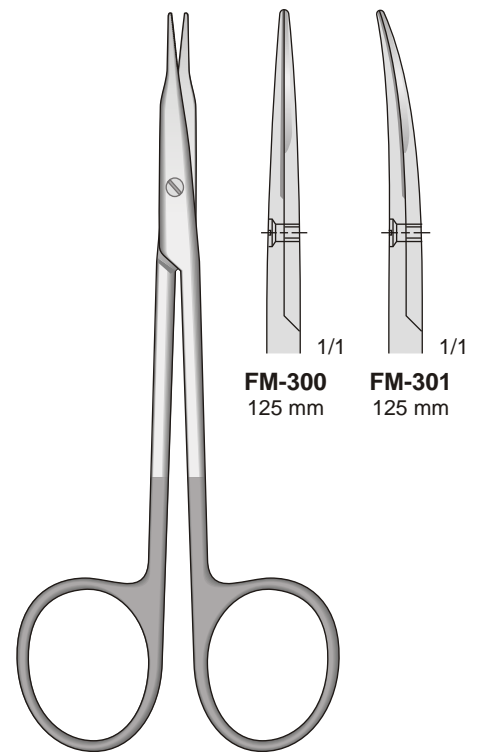

**STEVENS**  
**FM-300/FM-301**  
 125 mm

“Super-cut” scheren micro-schliff für tissue atrauma - “Super-cut” scissors for gripping tissue and cutting interproximally  
 Forbici “Super-cut” estremamente taglienti per tessuti con riduzione del trauma - Tijeras “super cortes” para cortar tissue-atrauma  
 Ciseaux “super cut” coupe les tissus en réduisant les risques de traumatisme

Gezahnte Scheren  
 Scissors Serrateds  
 Forbici Dentellate  
 Tijeras Dentada  
 Ciseaux Dentelé

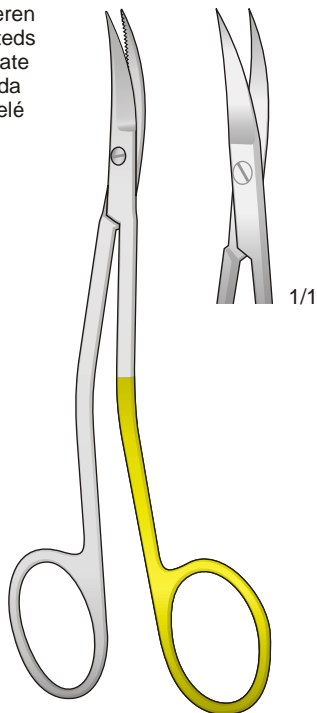

LA GRANGE  
**LG-1SC/LG-2SC**  
 115 mm

Spitz  
 Sharp  
 Acute  
 Agudas  
 Pointu

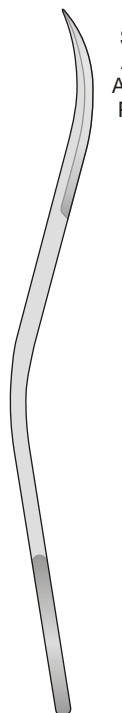

LA GRANGE  
**LG-1SC**

Stumpf  
 Blunt  
 Smusse  
 Romas  
 Mousse

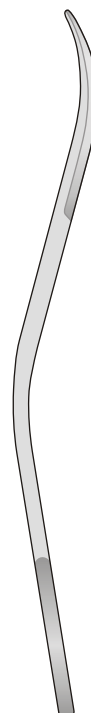

LA GRANGE  
**LG-2SC**

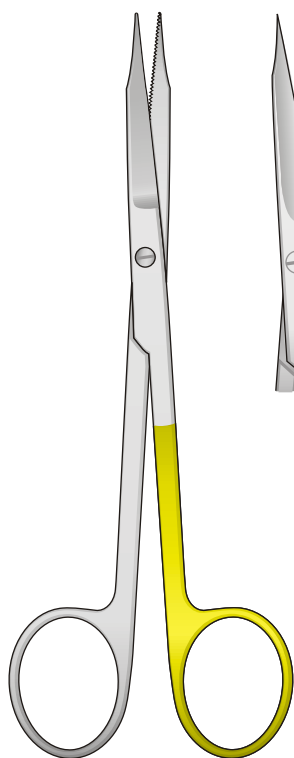

GOLDMAN-FOX  
**GFC-SC/GFR-SC**  
 135 mm



**GFR-SC**

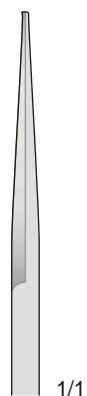

**GFC-SC**

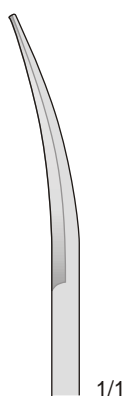

**GFS-SC**

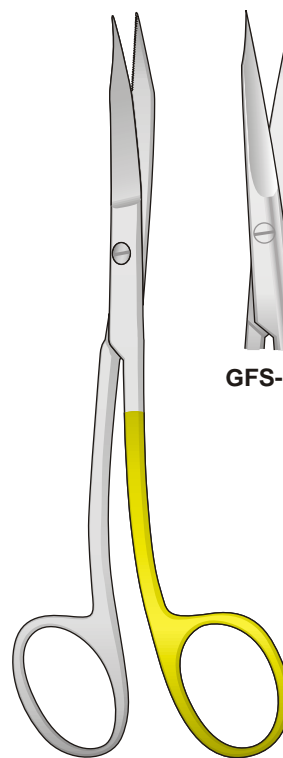

GOLDMAN-FOX  
**GFS-SC**  
 130 mm

S Form

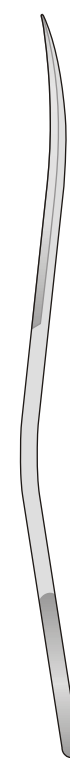

“Super-cut” scheren micro-schliff für tissue atrauma - “Super-cut” scissors for gripping tissue and cutting interproximally  
 Forbici “Super-cut” estremamente taglienti per tessuti con riduzione del trauma - Tijeras “super cortes” para cortar tissue-atrauma  
 Ciseaux “super cut” coupe les tissus en reduisant les risques de traumatisme

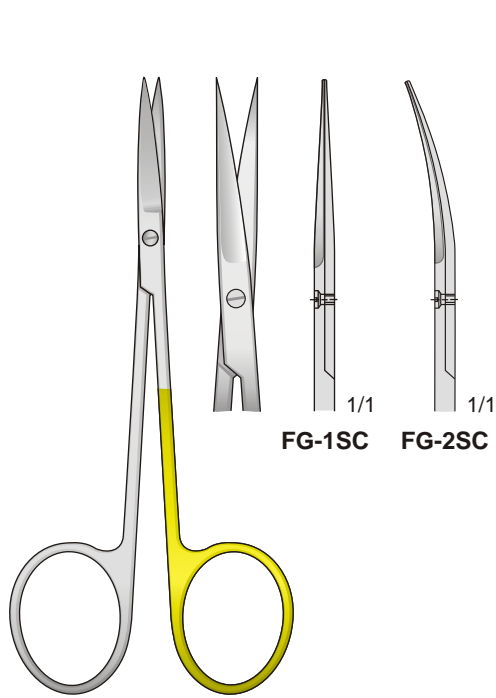

IRIS  
**FG-1SC/FG-2SC**  
 110 mm

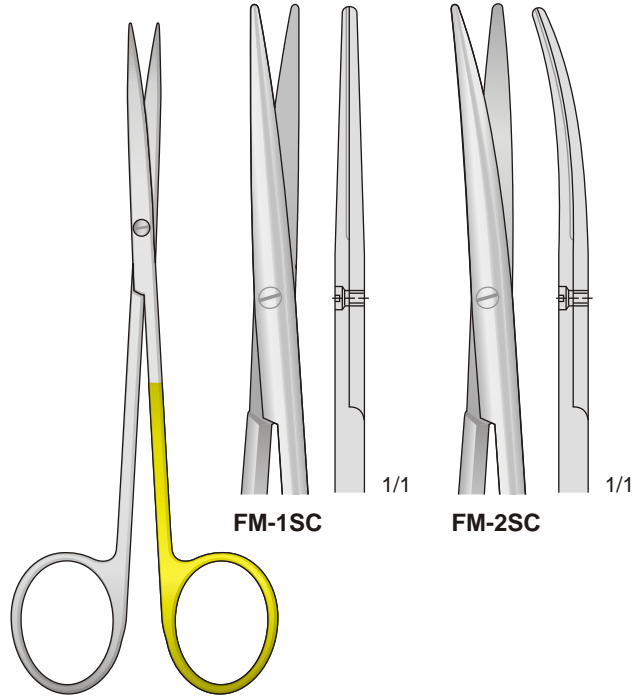

METZENBAUM  
**FM-1SC/FM-2SC**  
 145 mm

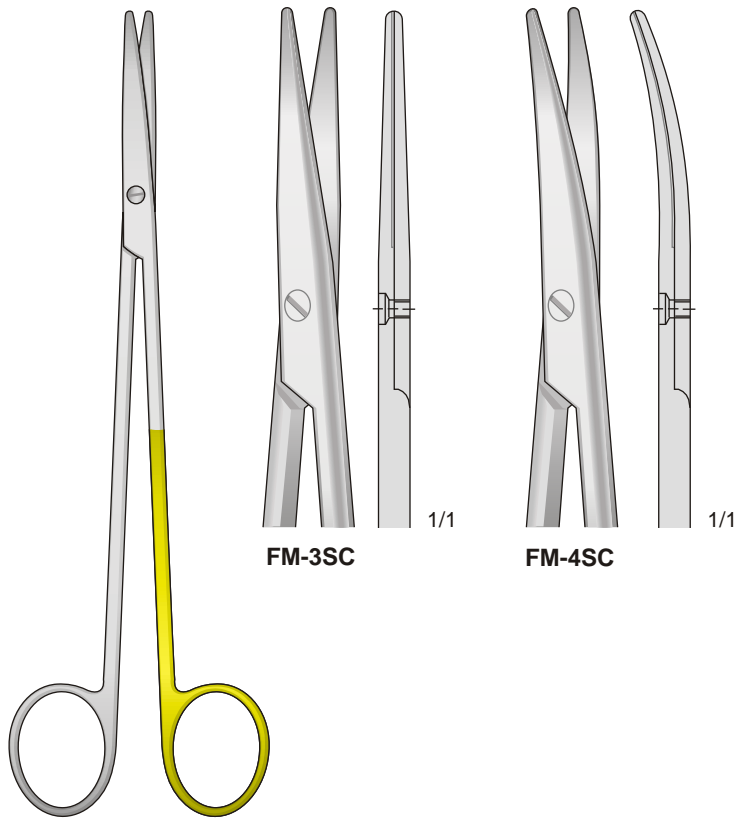

METZENBAUM  
**FM-3SC/FM-4SC**  
 185 mm

“Super-cut” scheren micro-schliff für tissue atrauma - “Super-cut” scissors for gripping tissue and cutting interproximally  
 Forbici “Super-cut” estremamente taglienti per tessuti con riduzione del trauma - Tijeras “super cortes” para cortar tissue-atrauma  
 Ciseaux “super cut” coupe les tissus en réduisant les risques de traumatisme

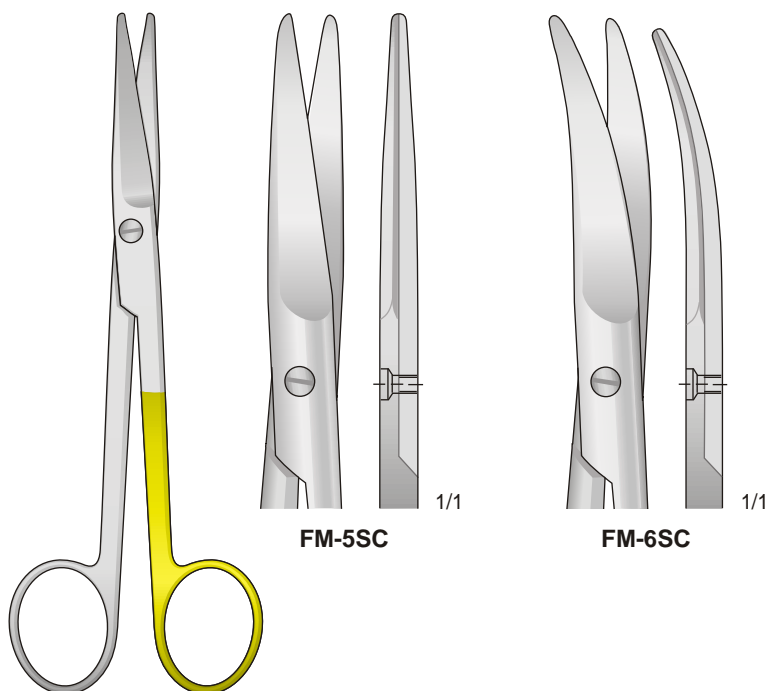

MAYO  
**FM-5SC/FM-6SC**  
 140 mm



MAYO  
**FM-24SC/FM25SC**  
 170 mm

**FM-29SC/FM30SC**  
 145 mm

L = links  
left  
mancini  
izquierda  
gauche

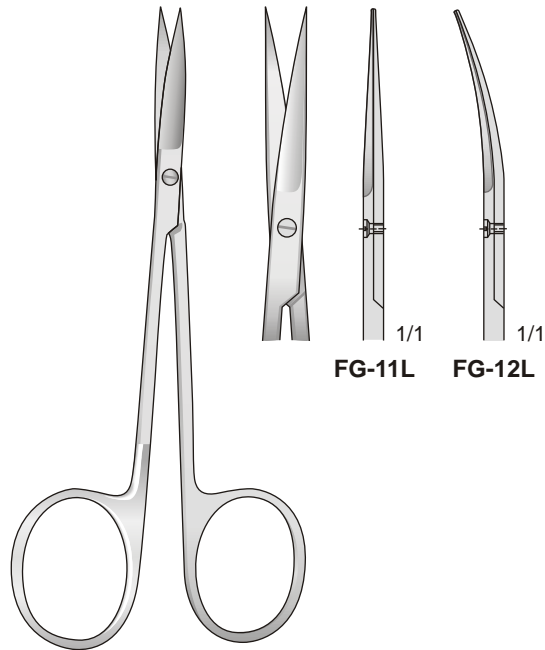

IRIS  
**FG-11L/FG-12L**  
110 mm

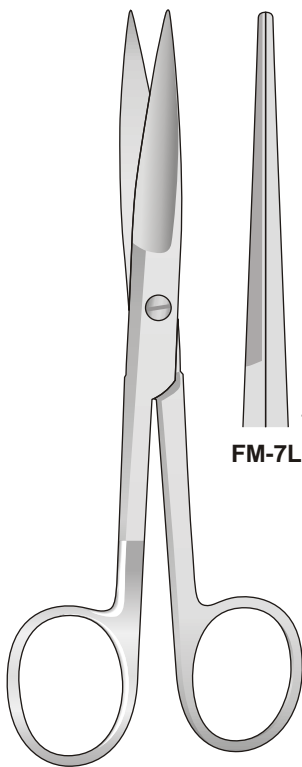

**FM-7L/FM-8L**  
145 mm

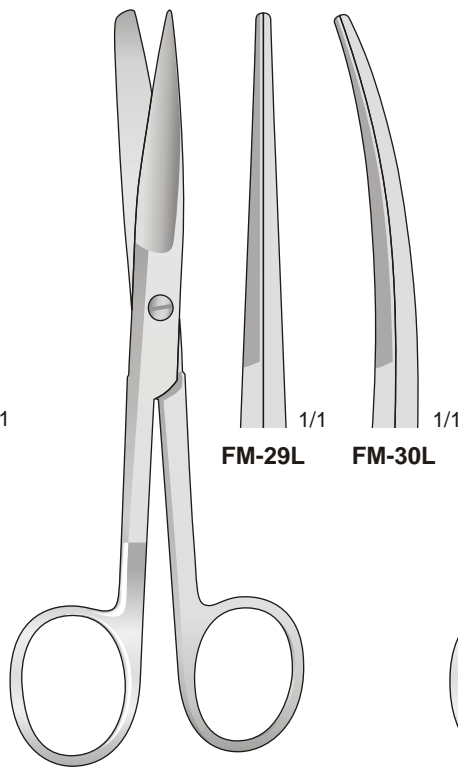

**FM-29L/FM-30L**  
145 mm

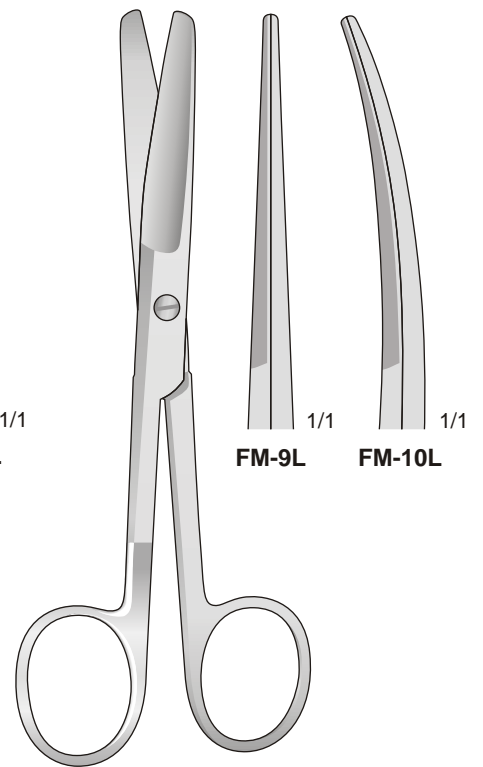

**FM-9L/FM-10L**  
145 mm



Mit Hartmetalleinsätzen - Tungsten-carbide scissors  
 Con punta al carburo di tungsteno - Tijeras de tungsteno - Avec plaquettes en carbure de tungstène

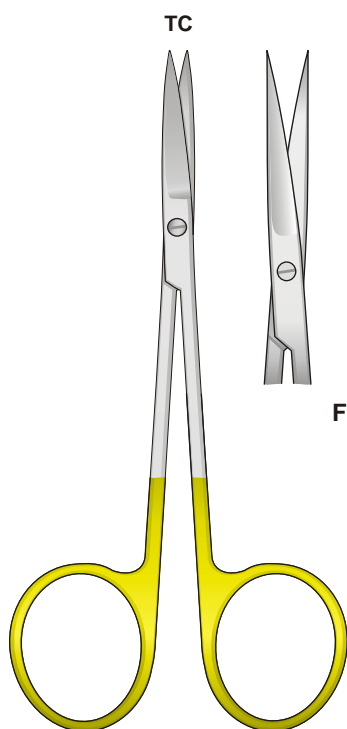

IRIS  
**FG1-TC/FG2-TC**  
 115 mm

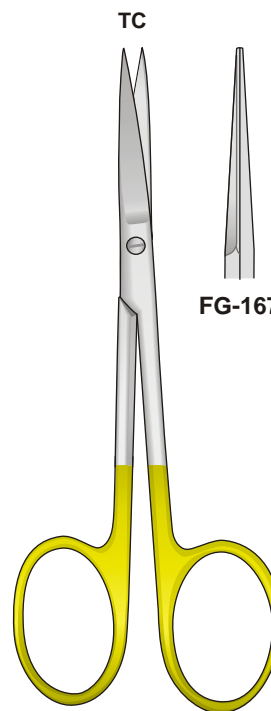
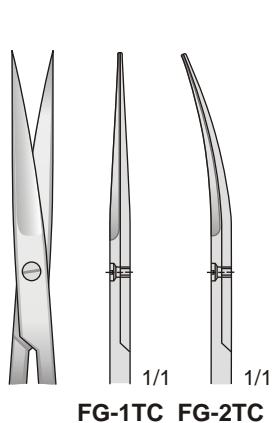

**FG-167/FG-168**  
 110 mm

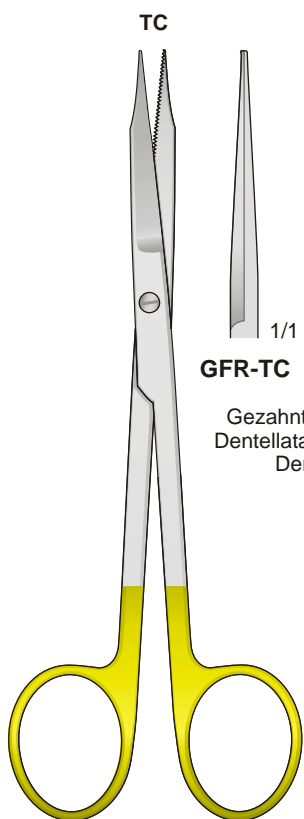
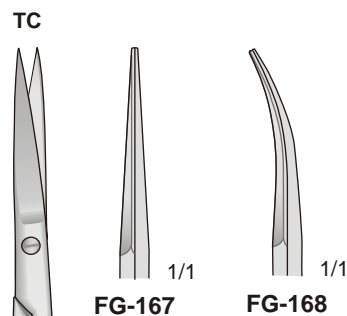

GOLDMAN-FOX  
**GFC-TC/GFR-TC**  
 135 mm

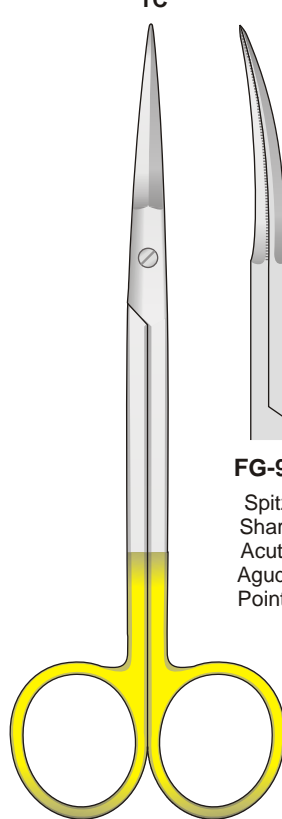
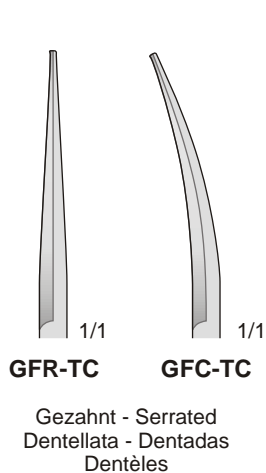

PECK-JOSEPH  
**FG-92/FG-98**  
 140 mm

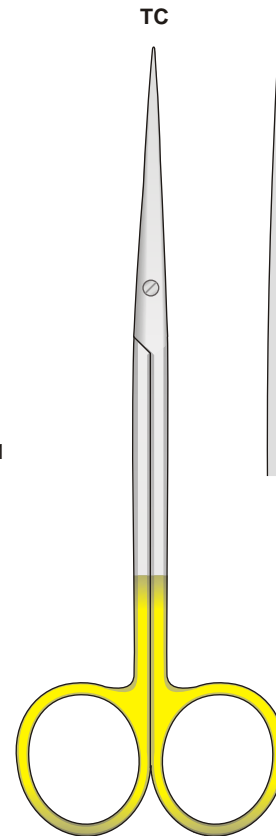
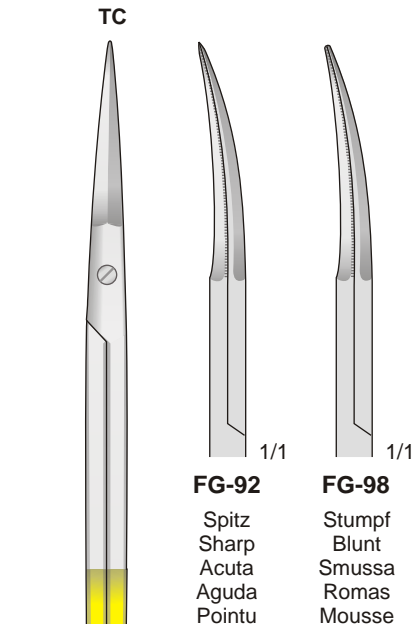

METZENBAUM-FINO  
**FM-96**  
 140 mm

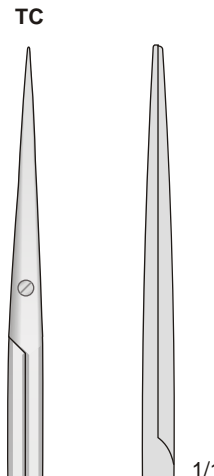

Mit Hartmetalleinsätzen - Tungsten-carbide scissors  
 Con punta al carburo di tungsteno - Tijeras de tungsteno - Avec plaquettes en carbure de tungstène

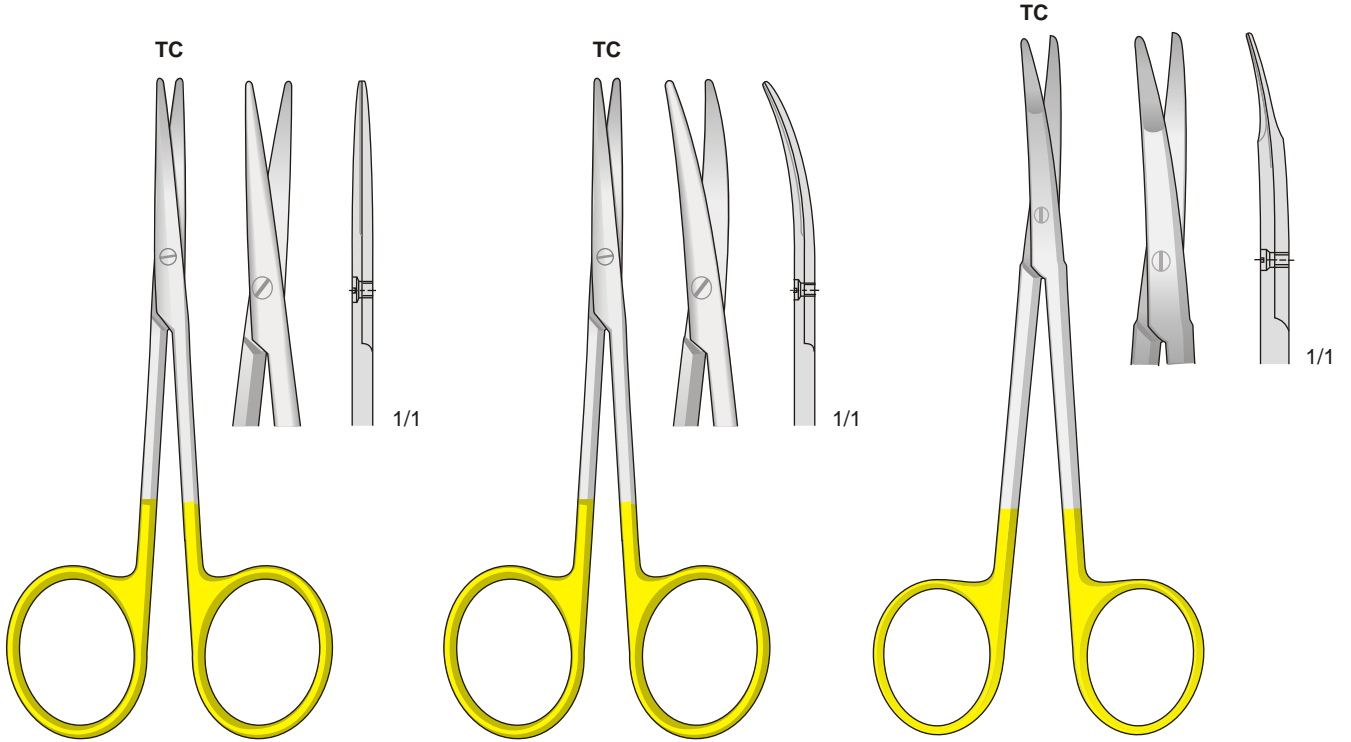

**FM-118**  
115 mm

**FM-119**  
115 mm

**KILNER (RAGNELL)**  
**FM-350**  
125 mm

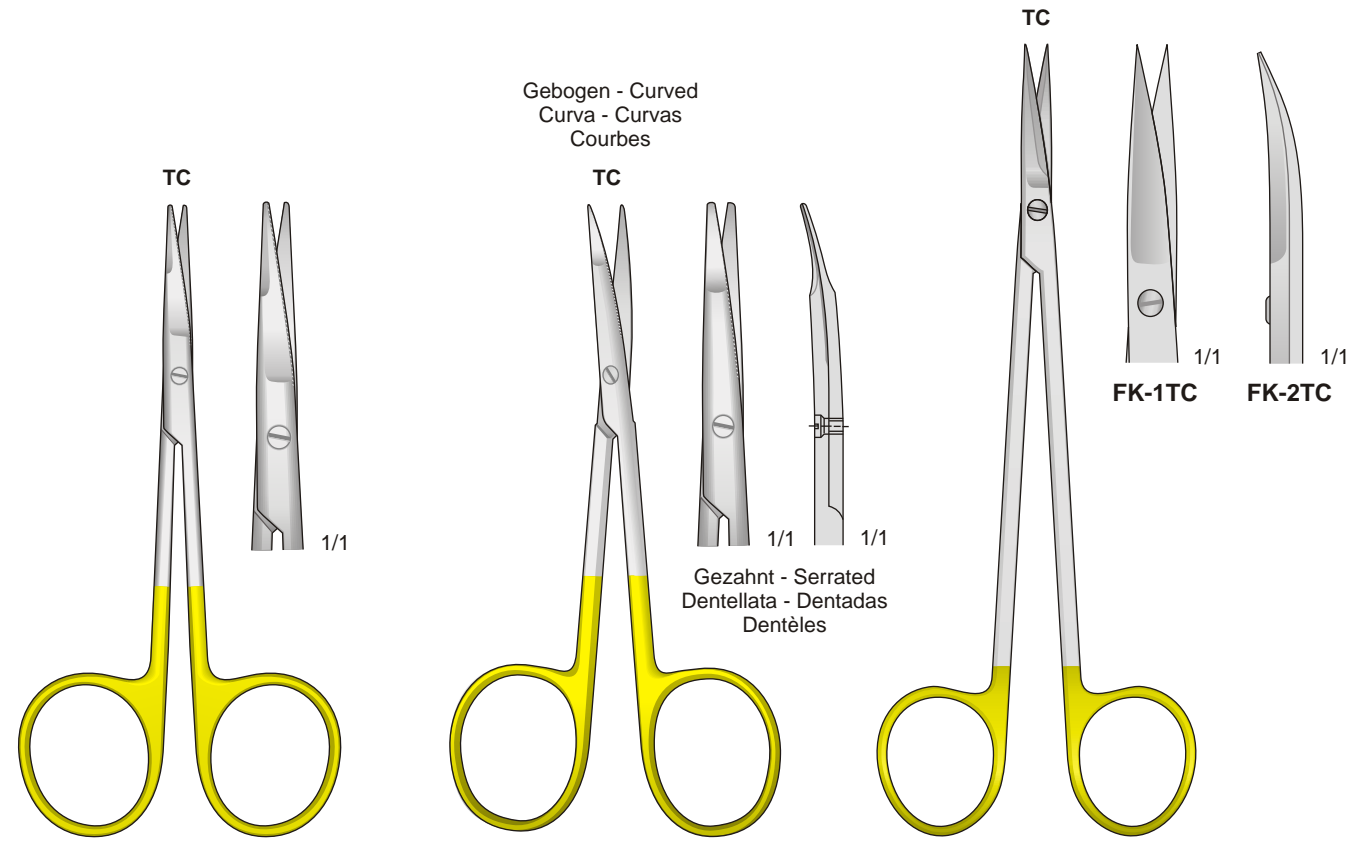

Gebogen - Curved  
 Curva - Curvas  
 Courbes

Gezahnt - Serrated  
 Dentellata - Dentadas  
 Dentèles

**PAR-TYPE**  
**FM-316**  
115 mm

**GREENBERG-PAR**  
**FM-317**  
115 mm

**KELLY**  
**FK-1TC/FK-2TC**  
160 mm

Mit Hartmetalleinsätzen - Tungsten-carbide scissors  
 Con punta al carburo di tungsteno - Tijeras de tungsteno - Avec plaquettes en carbure de tungstène

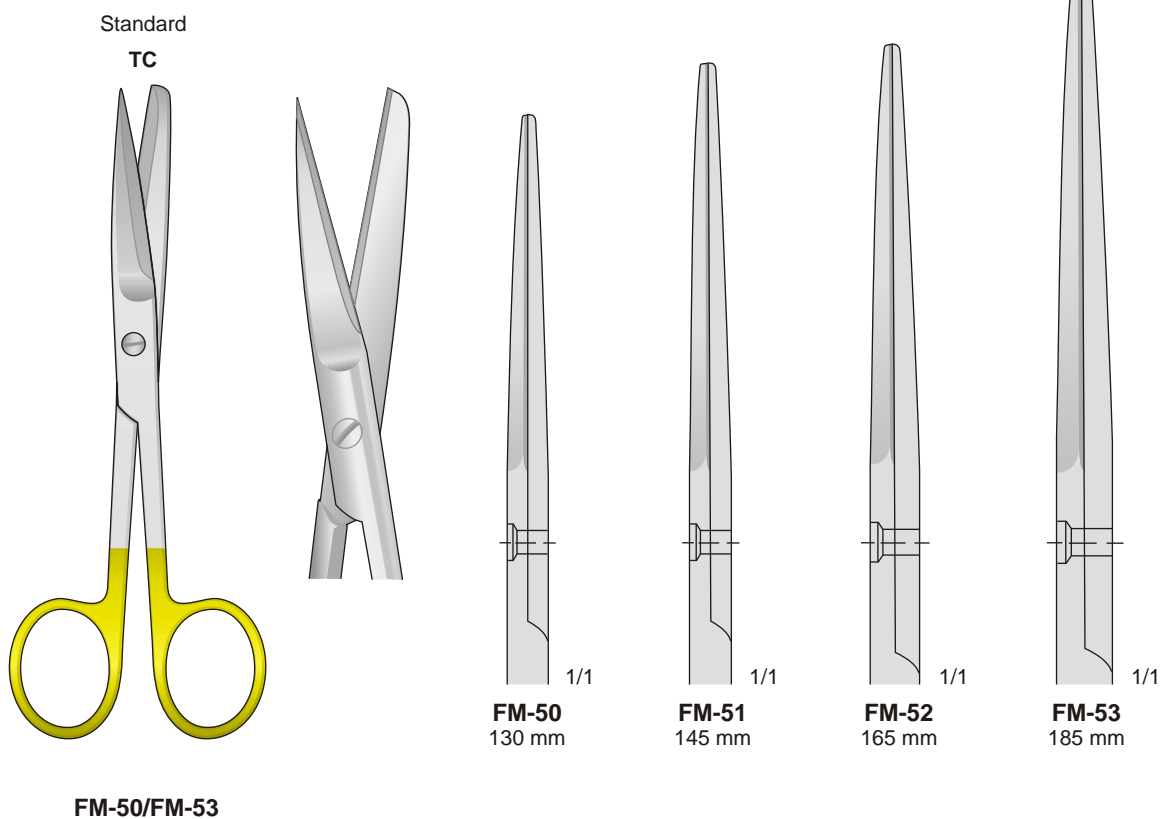

Mit Hartmetalleinsätzen - Tungsten-carbide scissors  
 Con punta al carburo di tungsteno - Tijeras de tungsteno - Avec plaquettes en carbure de tungstène

Standard  
**TC**

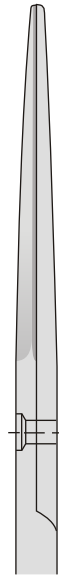
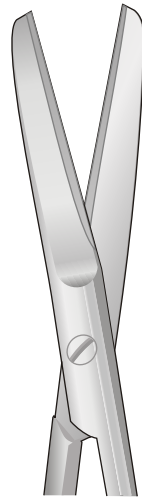
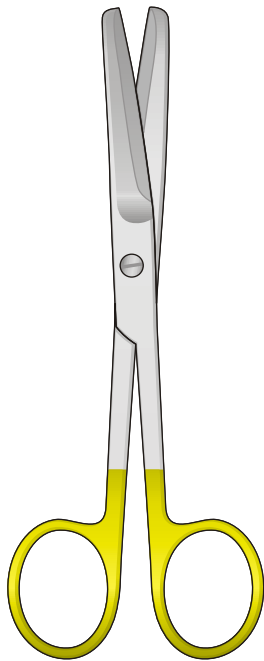

**FM-54**  
130 mm

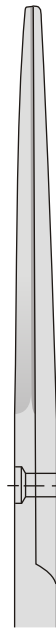

**FM-55**  
145 mm

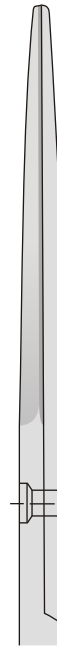

**FM-56**  
165 mm

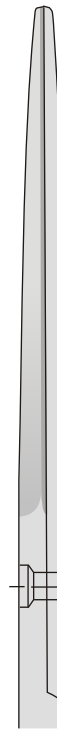

**FM-57**  
185 mm

**FM-54/FM-57**

**TC**

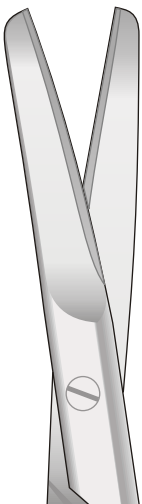
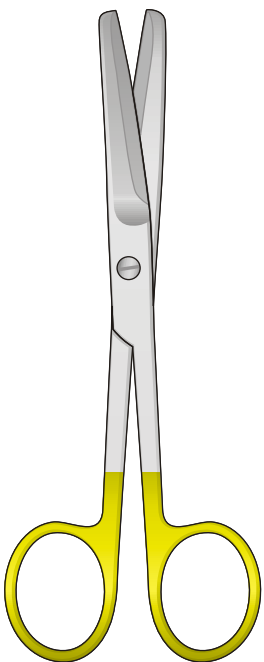

**FM-151**  
130 mm



**FM-152**  
145 mm



**FM-153**  
165 mm

**FM-151/FM-153**

Mit Hartmetalleinsätzen - Tungsten-carbide scissors  
 Con punta al carburo di tungsteno - Tijeras de tungsteno - Avec plaquettes en carbure de tungstène

Standard  
 TC

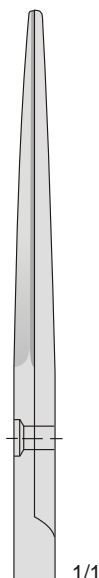
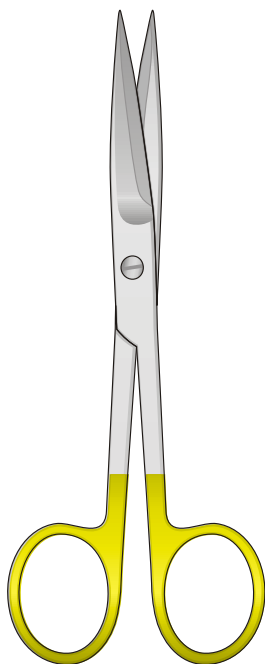

**FM-58**  
130 mm

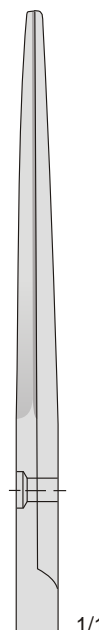

**FM-59**  
145 mm

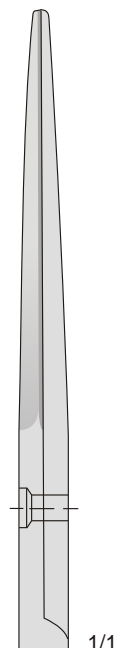

**FM-60**  
165 mm

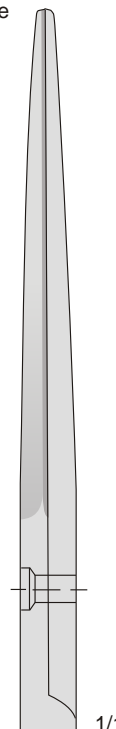

**FM-61**  
185 mm

**FM-58/FM-61**

TC

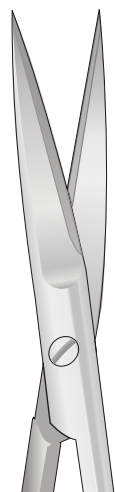
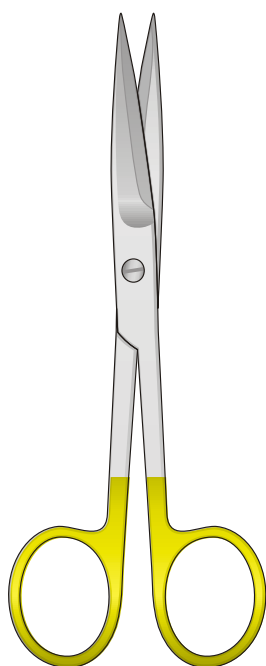

**FM-145**  
130 mm



**FM-146**  
145 mm



**FM-147**  
165 mm

**FM-145/FM-147**

Mit Hartmetalleinsätzen - Tungsten-carbide scissors  
 Con punta al carburo di tungsteno - Tijeras de tungsteno - Avec plaquettes en carbure de tungstène

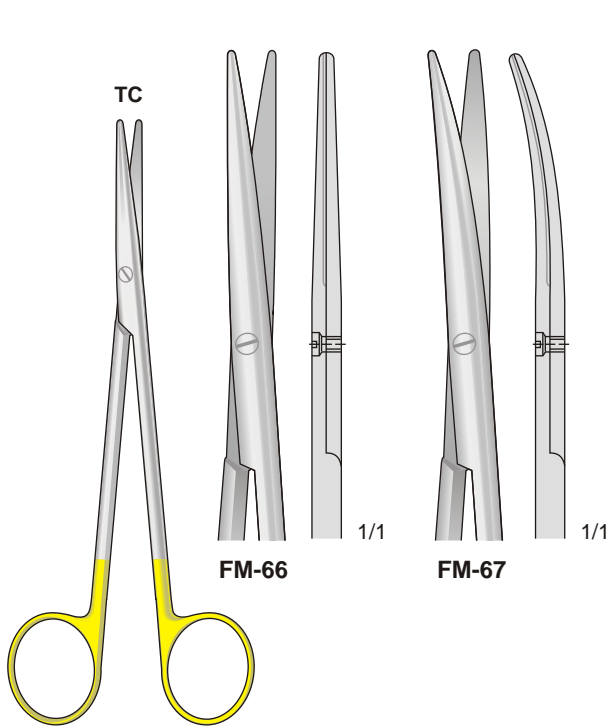

**METZENBAUM**  
**FM-66/FM-67**  
 145 mm

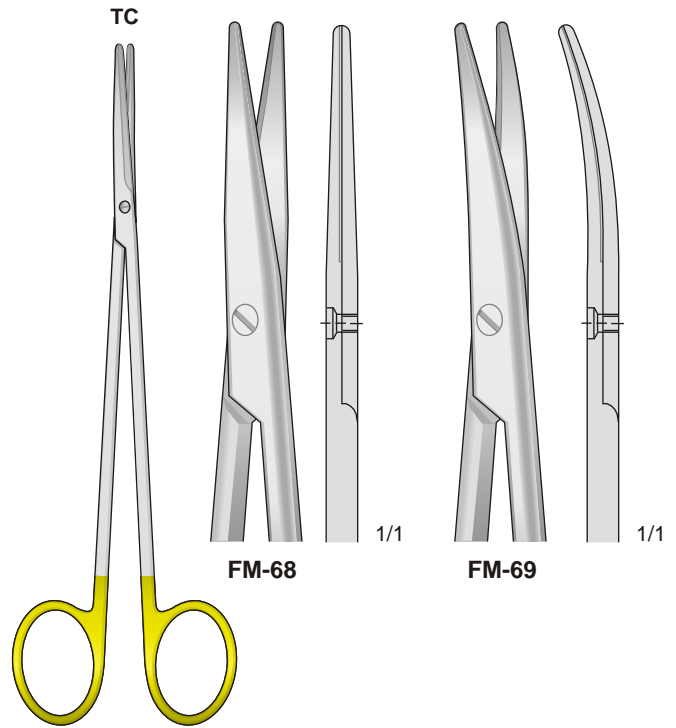

**METZENBAUM**  
**FM-68/FM-69**  
 185 mm

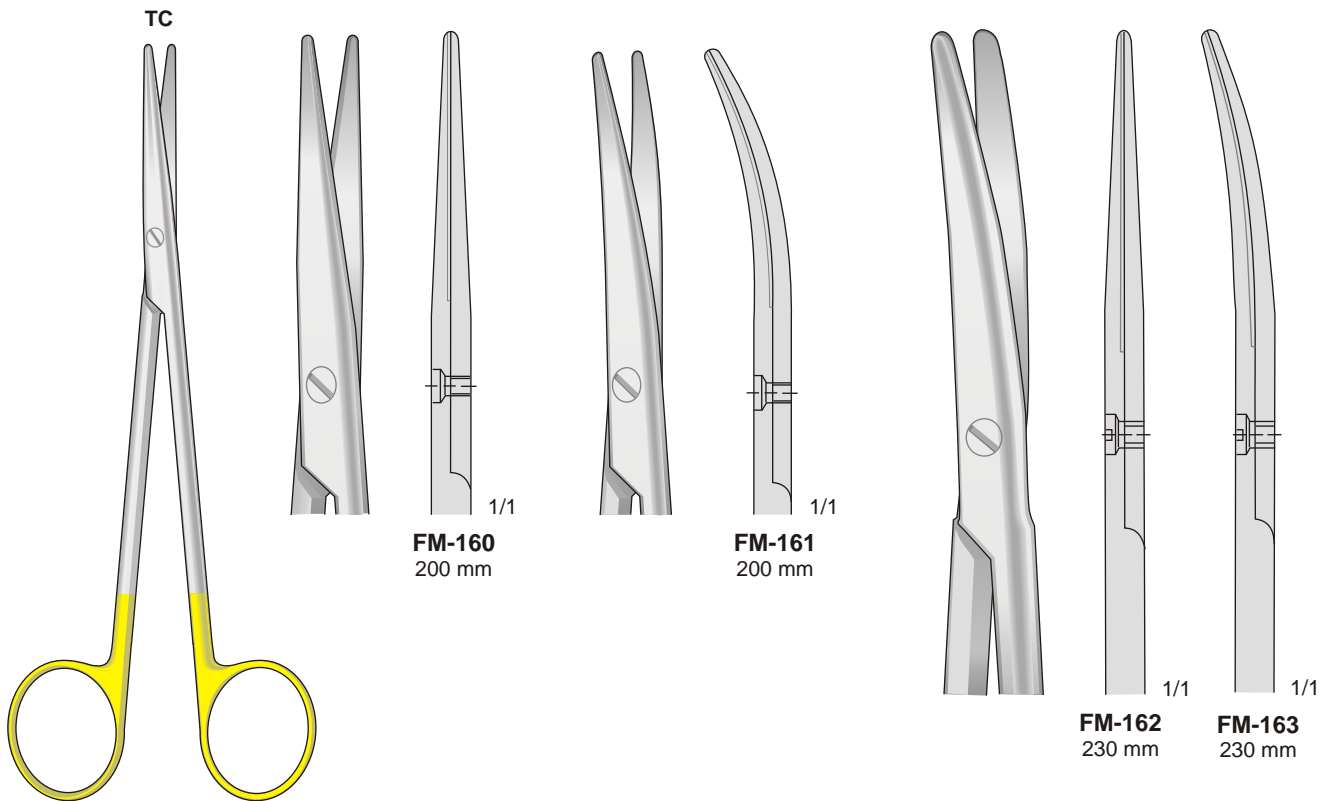

**METZENBAUM**  
**FM-160/FM-163**

Mit Hartmetalleinsätzen - Tungsten-carbide scissors  
 Con punta al carburo di tungsteno - Tijeras de tungsteno - Avec plaquettes en carbure de tungstène

TC

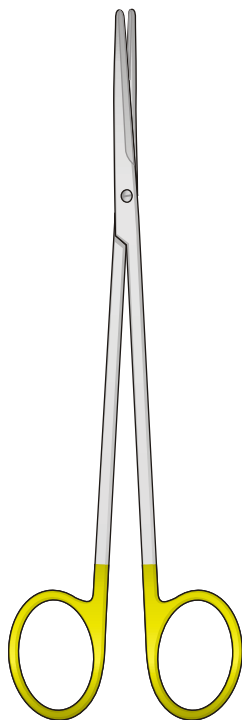

METZENBAUM-FINO  
 FM-201/FM-205

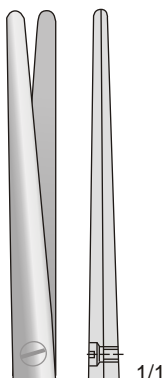

**FM-201**  
 140 mm

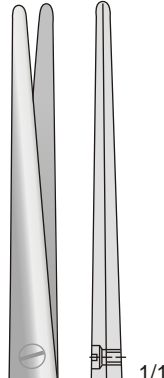

**FM-203**  
 180 mm

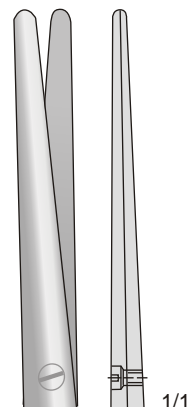

**FM-205**  
 200 mm

TC

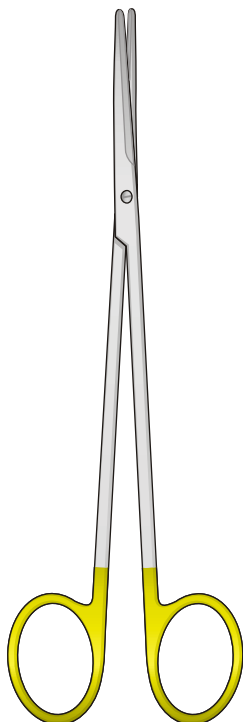

METZENBAUM-FINO  
 FM-207/FM-211

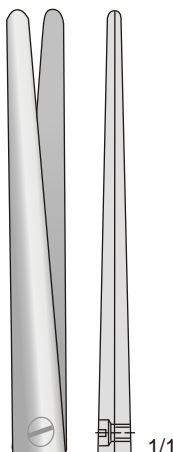

**FM-207**  
 230 mm

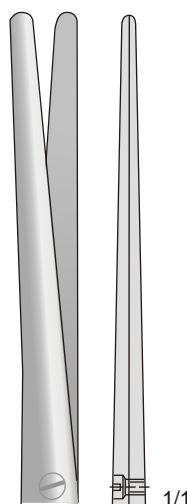

**FM-209**  
 250 mm

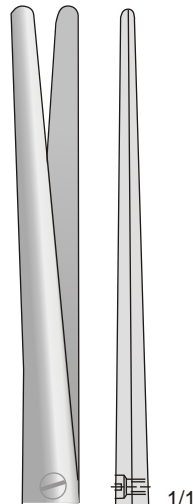

**FM-211**  
 280 mm

Mit Hartmetalleinsätzen - Tungsten-carbide scissors  
 Con punta al carburo di tungsteno - Tijeras de tungsteno - Avec plaquettes en carbure de tungstène

**TC**

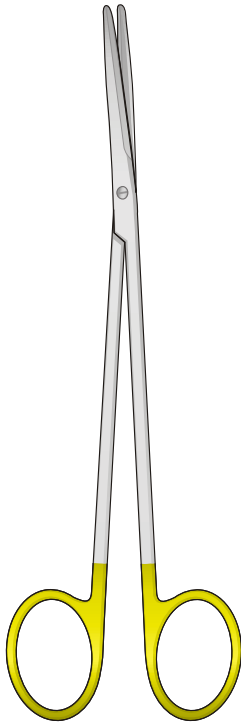

**METZENBAUM-FINO  
 FM-202/FM-206**

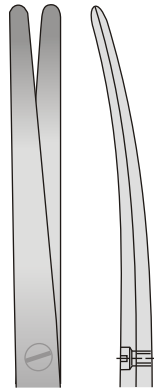

**FM-202  
 140 mm**

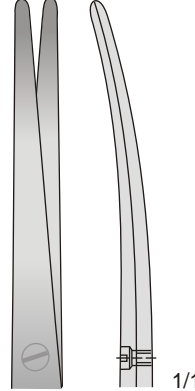

**FM-204  
 180 mm**



**FM-206  
 200 mm**

**TC**

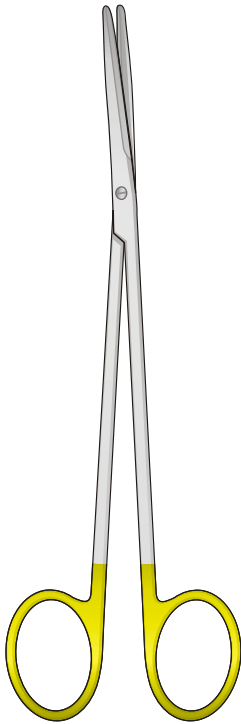

**METZENBAUM-FINO  
 FM-208/FM-212**

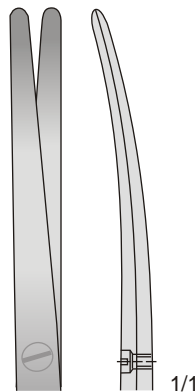

**FM-208  
 230 mm**

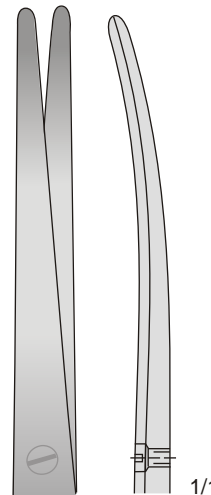

**FM-210  
 250 mm**



**FM-212  
 280 mm**



Mit Hartmetalleinsätzen - Tungsten-carbide scissors  
 Con punta al carburo di tungsteno - Tijeras de tungsteno - Avec plaquettes en carbure de tungstène

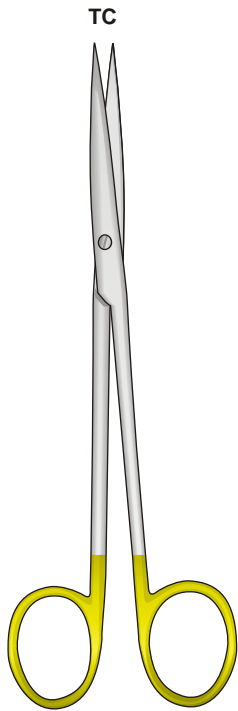

TC

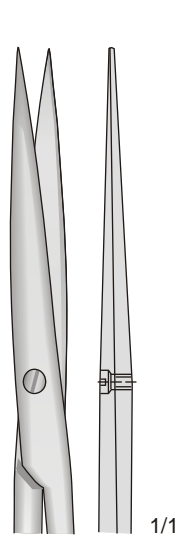

**FM-96**  
140 mm

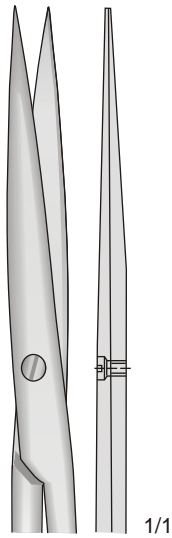

**FM-97**  
180 mm

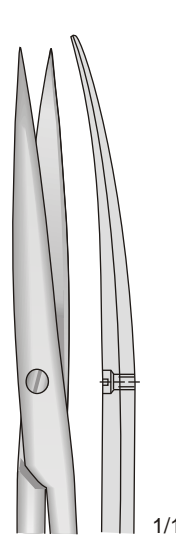

**FM-98**  
140 mm

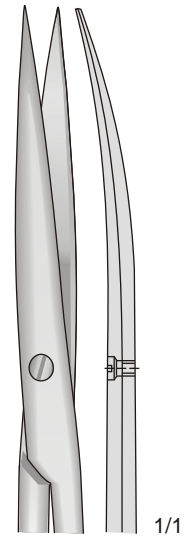

**FM-99**  
180 mm

METZENBAUM-FINO  
FM-96/FM-99

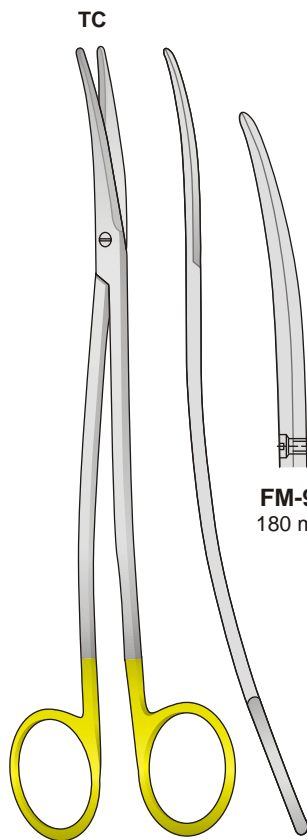

TC

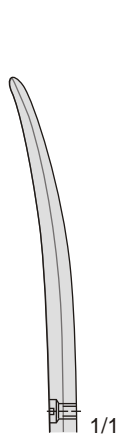

**FM-90**  
180 mm



**FM-92**  
200 mm

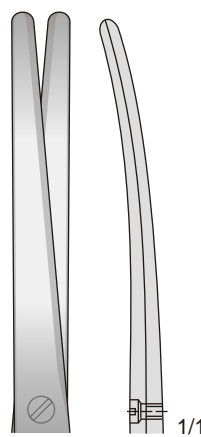

**FM-94**  
230 mm

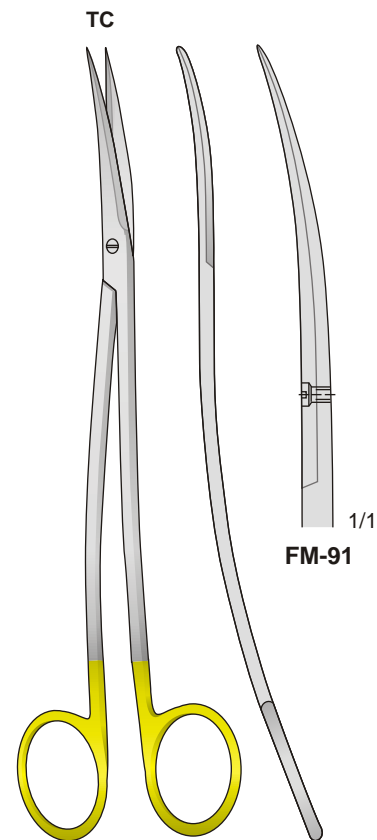

TC

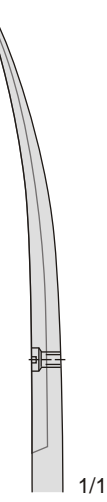

**FM-91**

METZENBAUM-FINO  
FM-90/FM-94

METZENBAUM-FINO  
FM-91  
180 mm

Mit Hartmetalleinsätzen - Tungsten-carbide scissors  
 Con punta al carburo di tungsteno - Tijeras de tungsteno - Avec plaquettes en carbure de tungstène

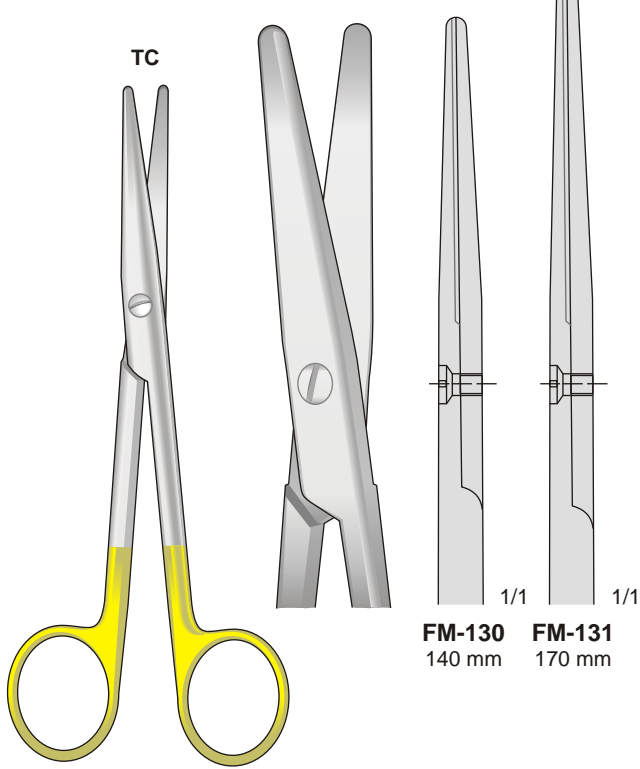

MAYO-STILLE  
**FM-130/FM-131**

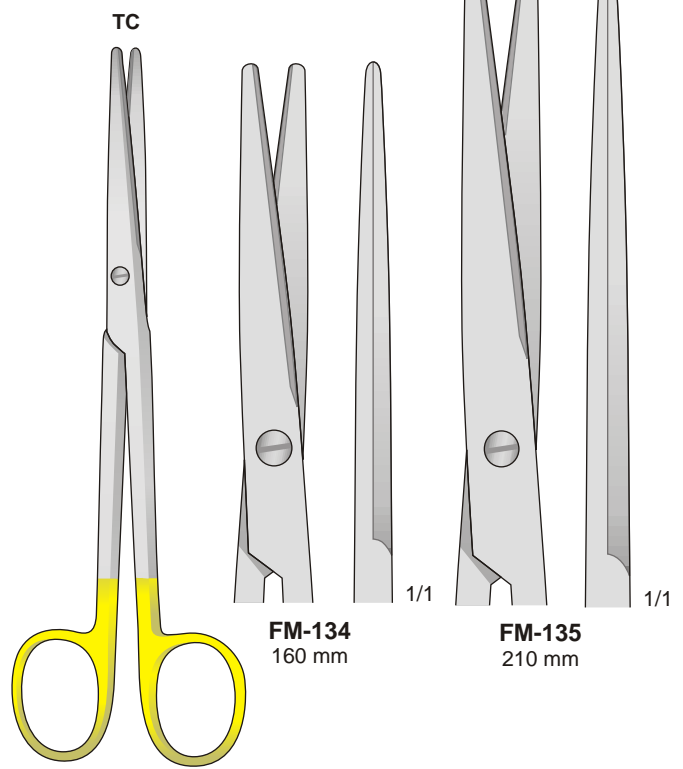

LEXER  
**FM-134/FM-135**

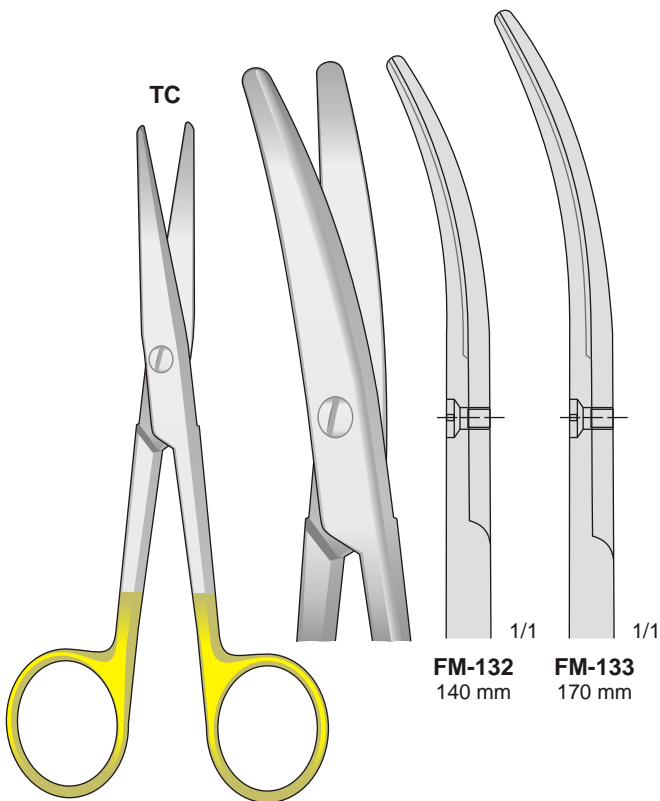

MAYO-STILLE  
**FM-132/FM-133**

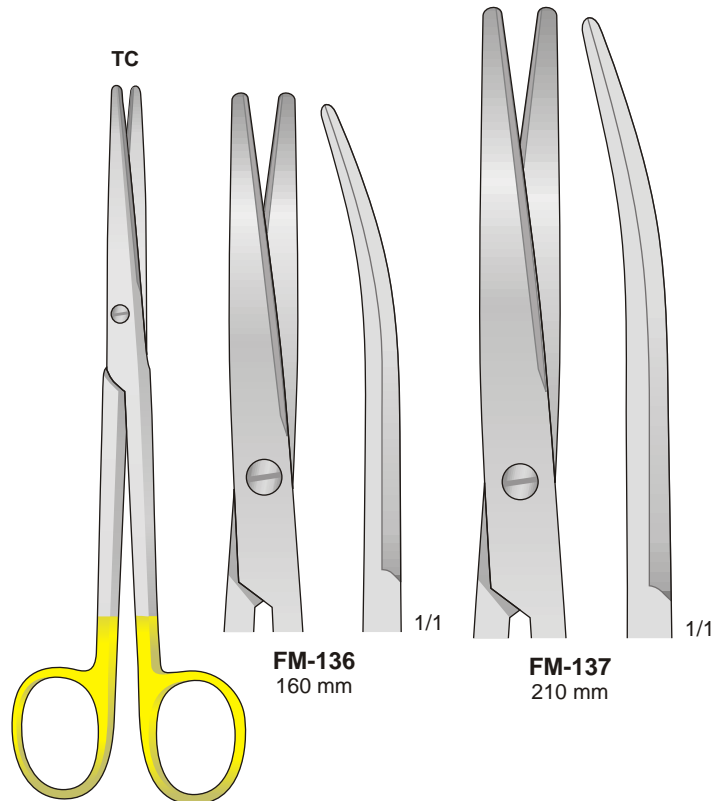

LEXER  
**FM-136/FM-137**

Mit Hartmetalleinsätzen - Tungsten-carbide scissors  
 Con punta al carburo di tungsteno - Tijeras de tungsteno - Avec plaquettes en carbure de tungstène

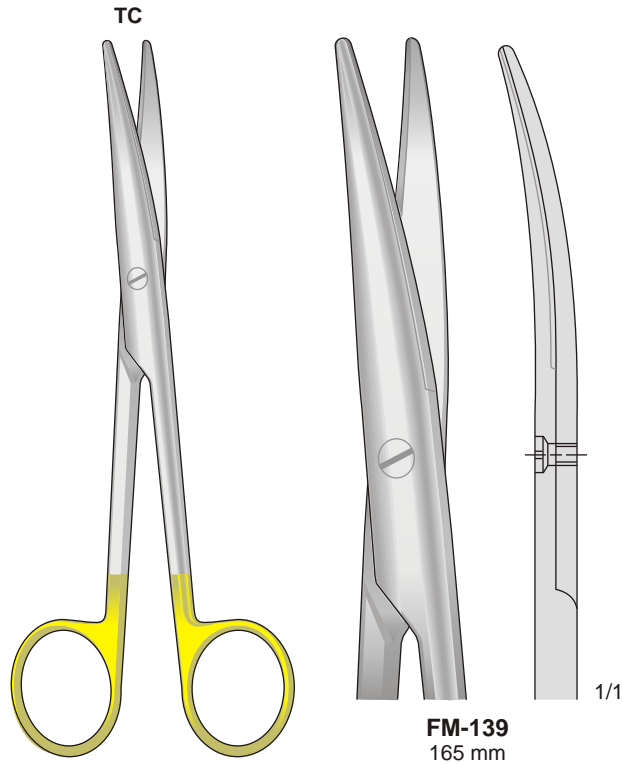

MAYO-LEXER  
**FM-139**  
 165 mm

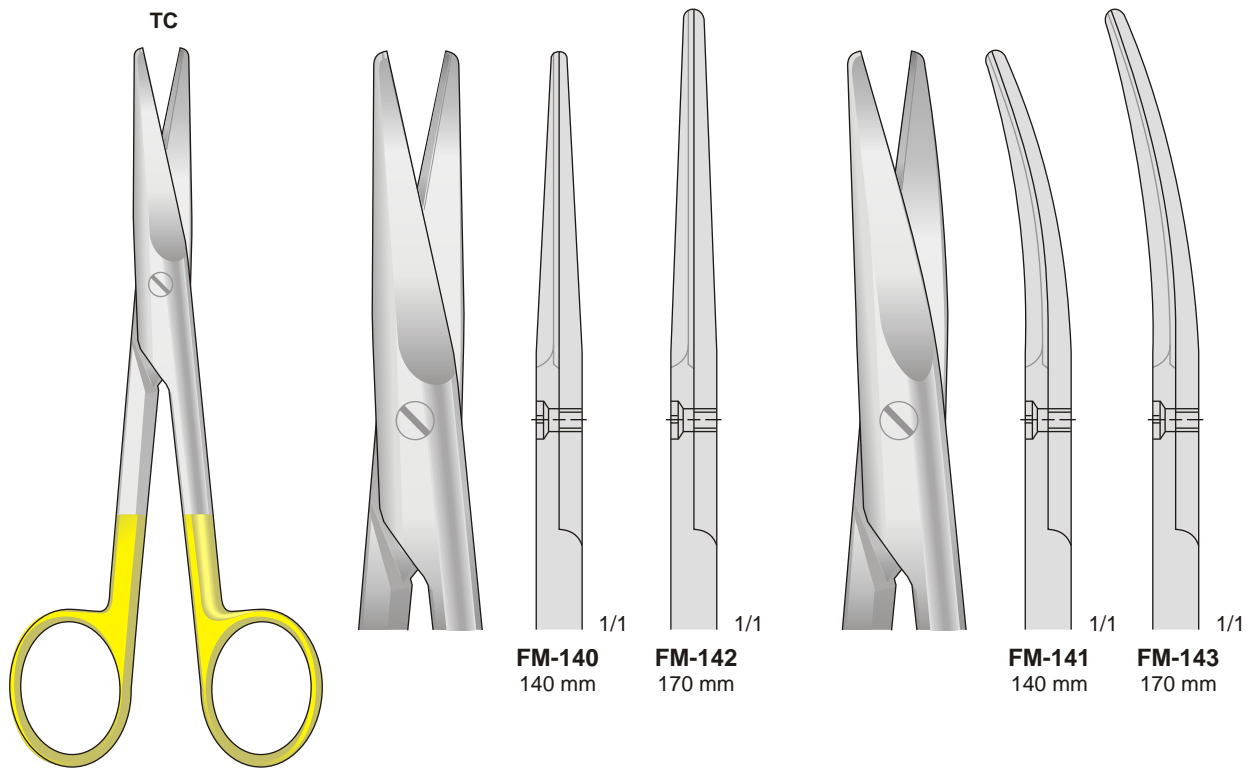

MAYO  
**FM-140/FM-143**

Mit Hartmetalleinsätzen - Tungsten-carbide scissors  
 Con punta al carburo di tungsteno - Tijeras de tungsteno - Avec plaquettes en carbure de tungstène

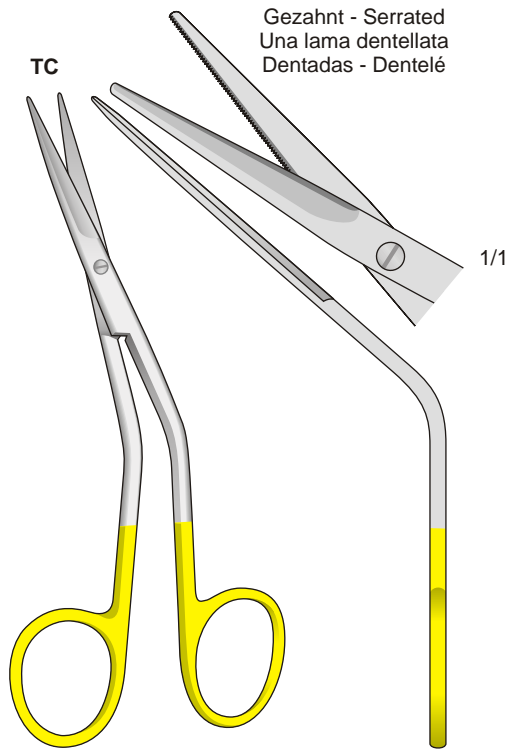

**FOMON  
 FG-165  
 135 mm**

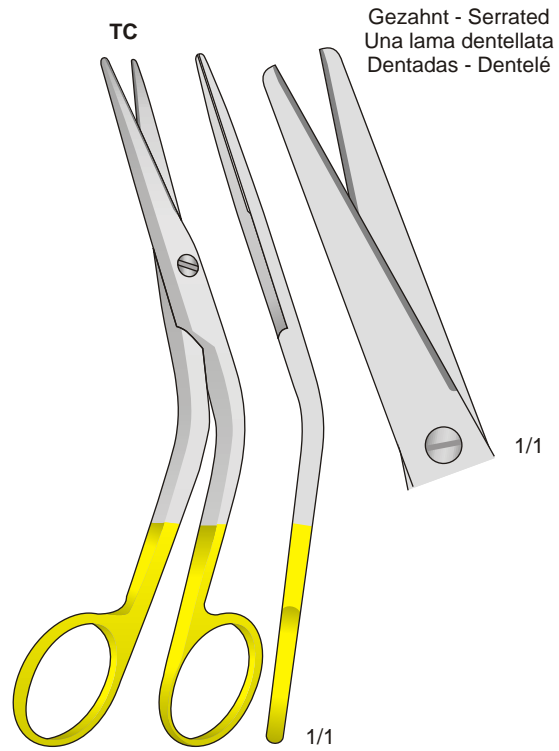

**COTTLE  
 FG-166  
 160 mm**

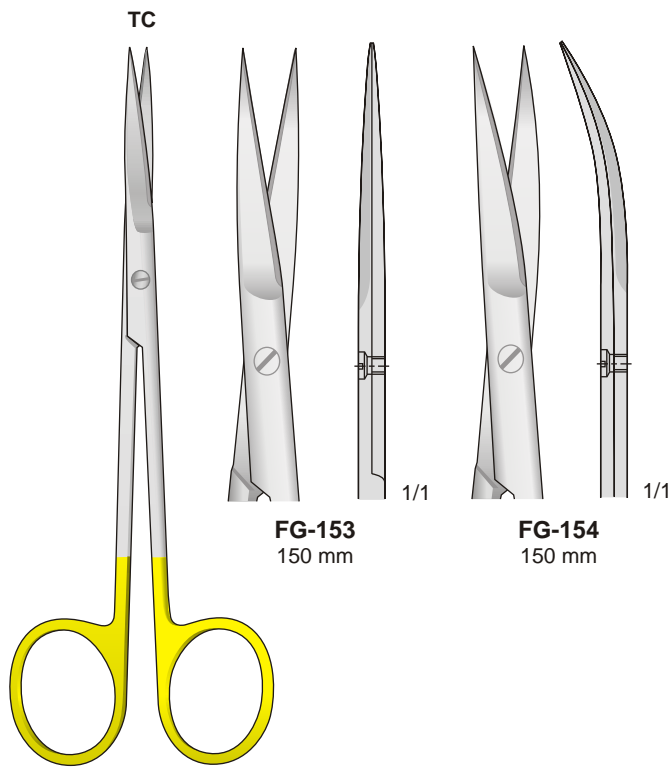

**JOSEPH  
 FG-153/FG-154  
 150 mm**

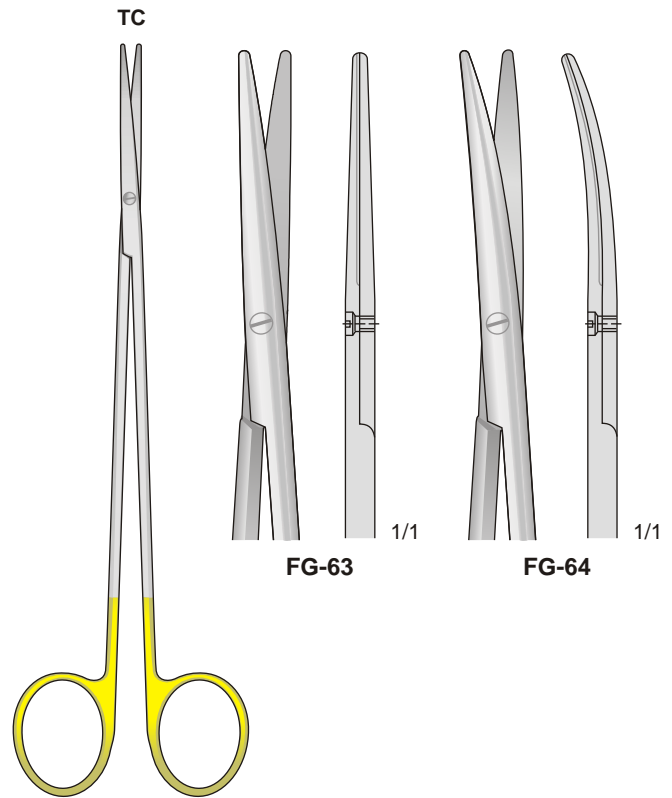

**TOENNIS-ADSON  
 FG-63/FG-64  
 180 mm**

Ligaturscheren

Ligature scissors

Forbici per suture

Tijeras para ligaduras

Ciseaux à ligatures

Mit Hartmetalleinsätzen - Tungsten-carbide scissors  
 Con punta al carburo di tungsteno - Tijeras de tungsteno - Avec plaquettes en carbure de tungstène

Scheren mit Wellenschliff auf einer Schnittfläche  
 Scissors cut one serrated cutting edge  
 Forbici con taglio ondulato su una lama  
 Tijeras con ondas afilados  
 Ciseaux avec affutage spécial ont une lame dentée

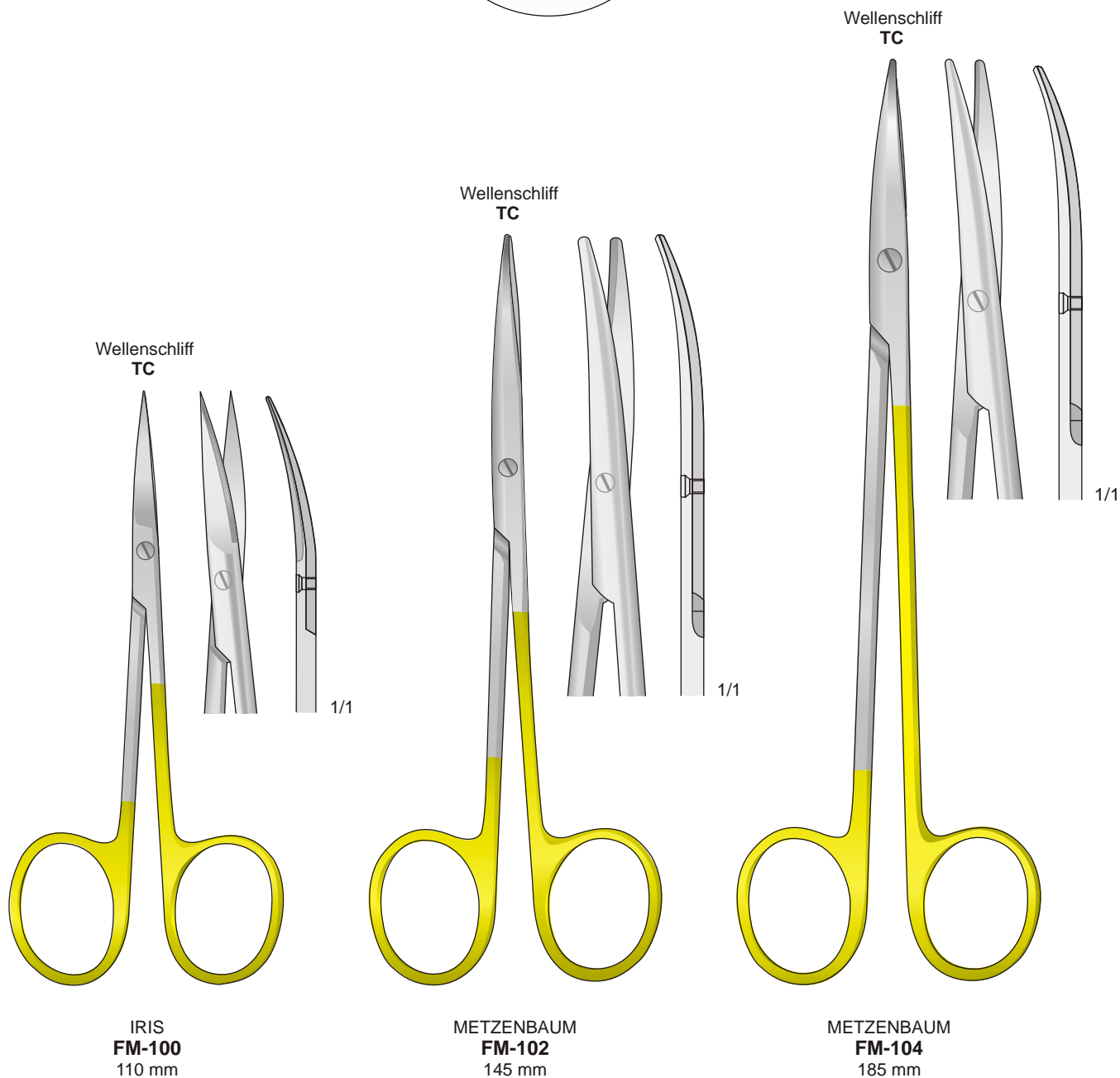
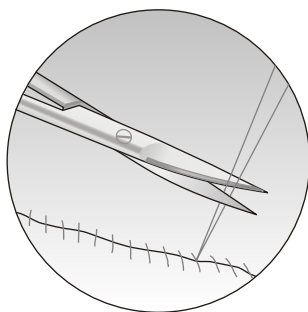

Mit Hartmetalleinsätzen - Tungsten-carbide scissors  
 Con punta al carburo di tungsteno - Tijeras de tungsteno - Avec plaquettes en carbure de tungstène

Mit einer Schneide gezahnt  
 With one blade serrated  
 Con una lama zigrinata  
 Con una hoja dentada  
 Avec lame dentèle

**TC**

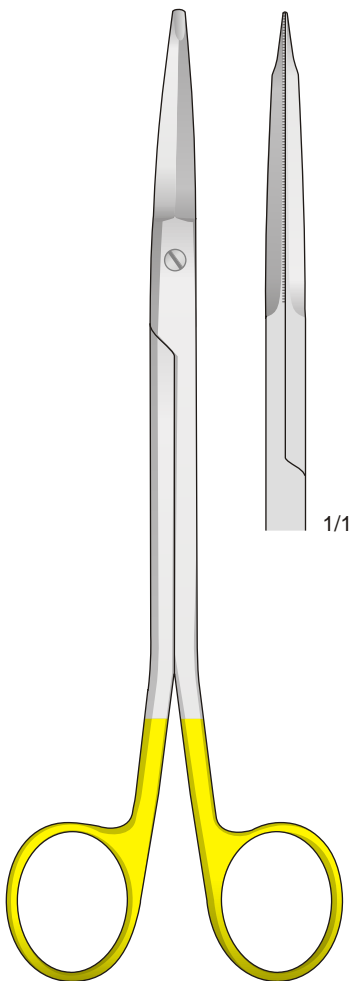

**FREEMAN-GORNEY**  
**FM-311**  
 180 mm

Mit einer Schneide gezahnt  
 With one blade serrated  
 Con una lama zigrinata  
 Con una hoja dentada  
 Avec lame dentèle

**TC**

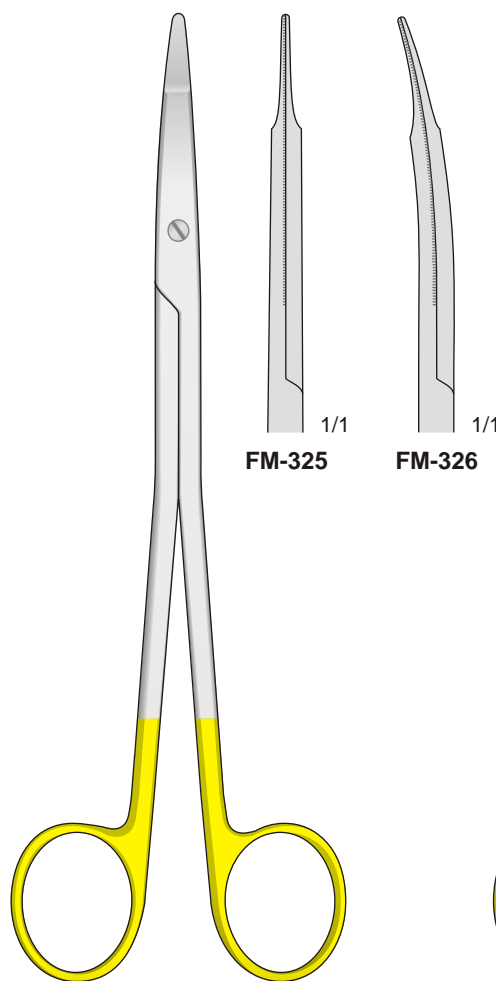

**FREEMAN**  
**FM-325/FM-326**  
 180 mm

Mit einer Schneide gezahnt  
 With one blade serrated  
 Con una lama zigrinata  
 Con una hoja dentada  
 Avec lame dentèle

**TC**

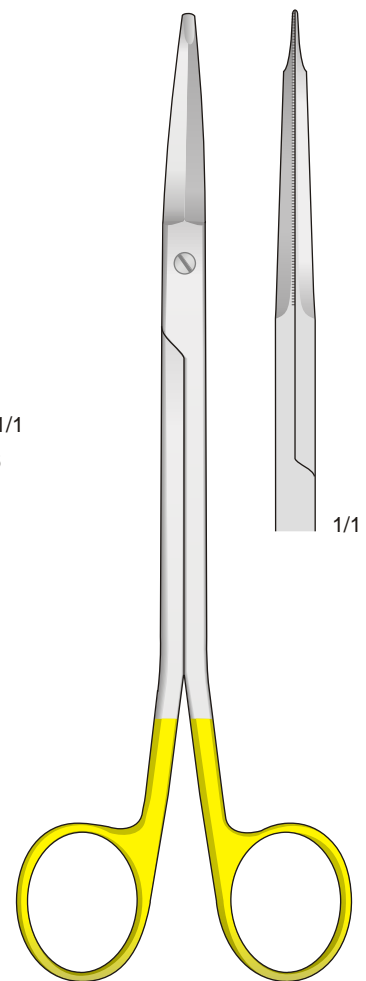

**FREEMAN-KAYE**  
**FM-334**  
 180 mm

Mit Hartmetalleinsätzen - Tungsten-carbide scissors  
 Con punta al carburo di tungsteno - Tijeras de tungsteno - Avec plaquettes en carbure de tungstène

Mit einer Schneide gezahnt  
 With one blade serrated  
 Con una lama zigrinata  
 Con una hoja dentada  
 Avec lame dentèle

TC

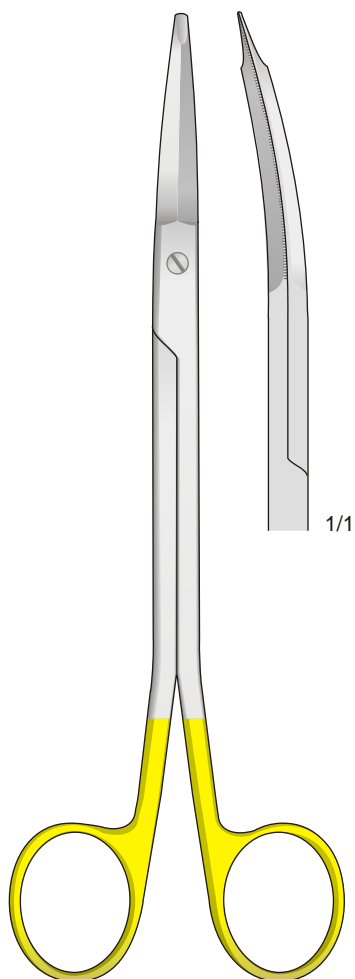

FREEMAN-KAYE  
**FM-335**  
 180 mm

Mit einer Schneide gezahnt  
 With one blade serrated  
 Con una lama zigrinata  
 Con una hoja dentada  
 Avec lame dentèle

TC

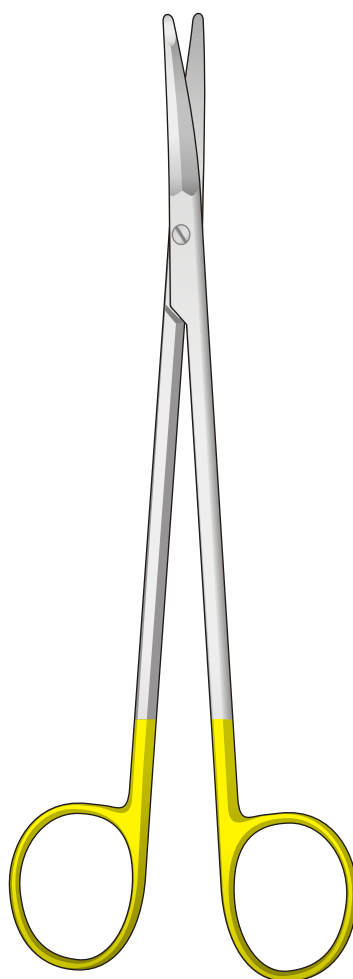

FACE LIFT  
**FM-338**  
 180 mm

Mit einer Schneide gezahnt  
 With one blade serrated  
 Con una lama zigrinata  
 Con una hoja dentada  
 Avec lame dentèle

TC

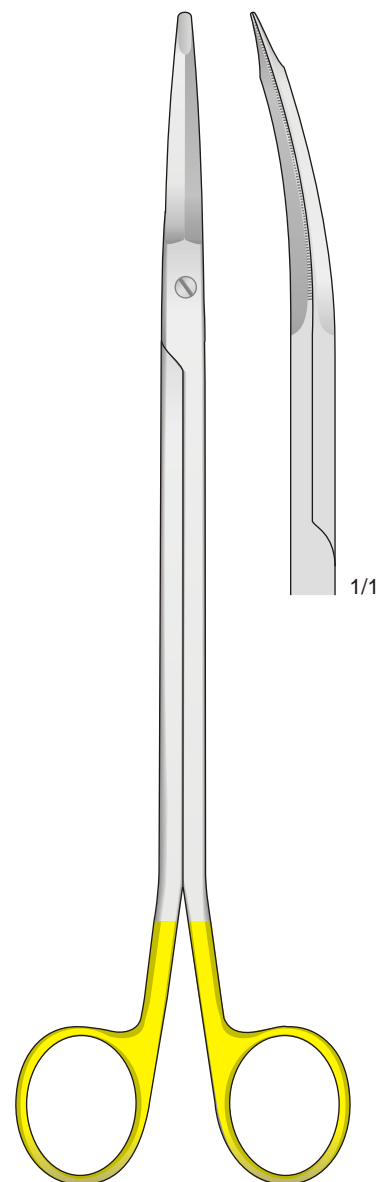

GORNEY  
**FM-312**  
 230 mm

Mit Hartmetalleinsätzen - Tungsten-carbide scissors  
 Con punta al carburo di tungsteno - Tijeras de tungsteno - Avec plaquettes en carbure de tungstène

Mit einer Schneide gezahnt  
 With one blade serrated  
 Con una lama zigrinata  
 Con una hoja dentada  
 Avec lame dentèle

Mit einer Schneide gezahnt  
 With one blade serrated  
 Con una lama zigrinata  
 Con una hoja dentada  
 Avec lame dentèle

S-Förmig Gebogen  
 S-Shaped  
 Forma S  
 Informa a S  
 Forme S

Mit einer Schneide gezahnt  
 With one blade serrated  
 Con una lama zigrinata  
 Con una hoja dentada  
 Avec lame dentèle



**GORNEY**  
**FM-320/FM-321**  
 180 mm

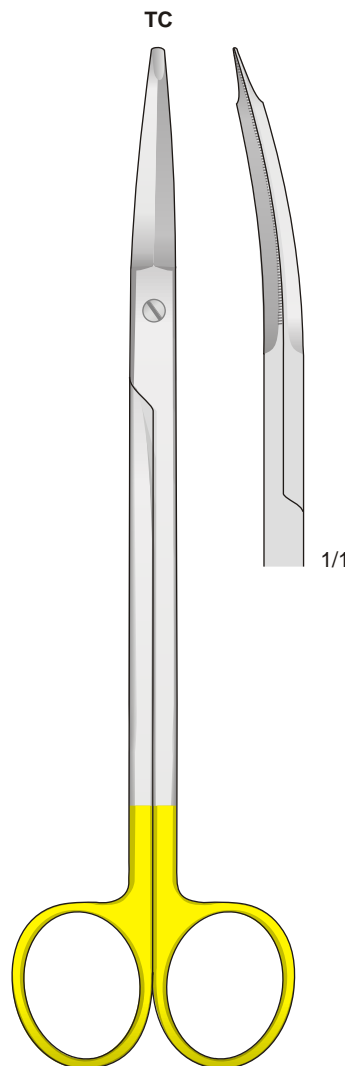

**GORNEY**  
**FM-323**  
 190 mm

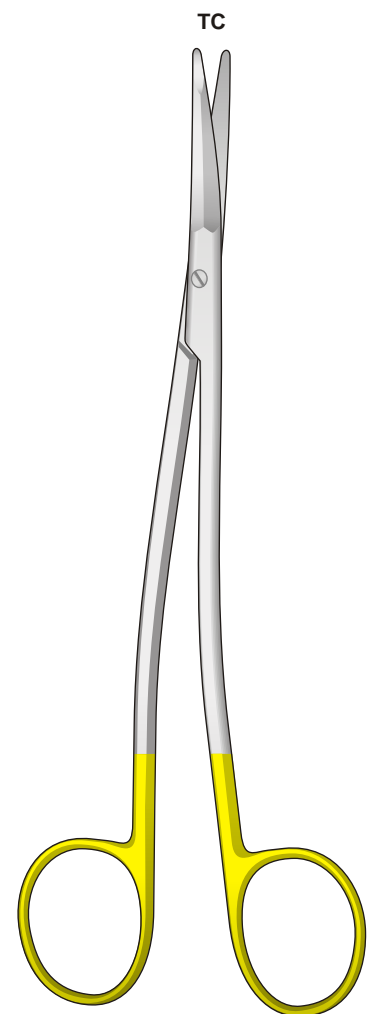

**STELLA**  
**FM-341**  
 180 mm



Mit Hartmetalleinsätzen - Tungsten-carbide scissors  
 Con punta al carburo di tungsteno - Tijeras de tungsteno - Avec plaquettes en carbure de tungstène

Mit einer Schneide gezahnt  
 With one blade serrated  
 Con una lama zigrinata  
 Con una hoja dentada  
 Avec lame dentèle

TC

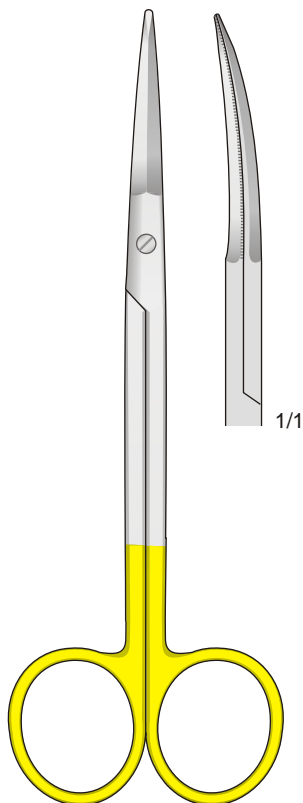

GREGORY  
**FM-339**  
 140 mm

Mit einer Schneide gezahnt  
 With one blade serrated  
 Con una lama zigrinata  
 Con una hoja dentada  
 Avec lame dentèle

TC

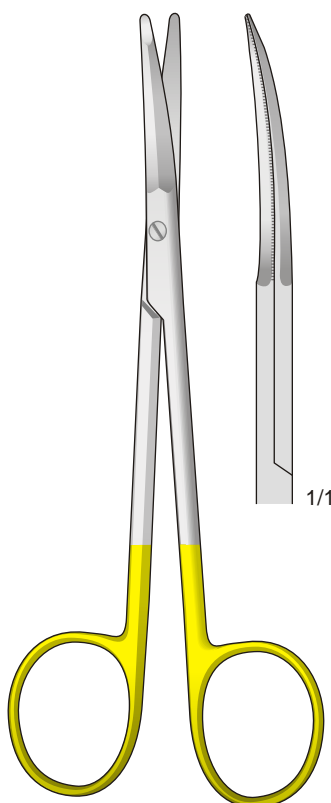

FACE LIFT  
**FM-340**  
 150 mm

Mit einer Schneide gezahnt  
 With one blade serrated  
 Con una lama zigrinata  
 Con una hoja dentada  
 Avec lame dentèle

TC

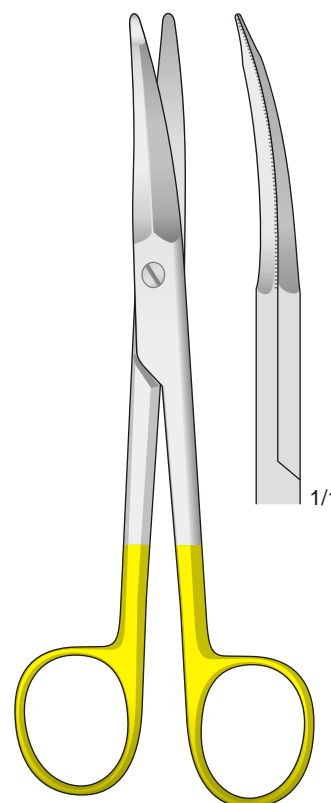

FACE LIFT  
**FM-342**  
 140 mm

Mit Hartmetalleinsätzen - Tungsten-carbide scissors  
 Con punta al carburo di tungsteno - Tijeras de tungsteno - Avec plaquettes en carbure de tungstène

Mit einer Schneide gezahnt  
 With one blade serrated  
 Con una lama zigrinata  
 Con una hoja dentada  
 Avec lame dentèle

Mit einer Schneide gezahnt  
 With one blade serrated  
 Con una lama zigrinata  
 Con una hoja dentada  
 Avec lame dentèle

**TC**

**TC**

Mit einer Schneide gezahnt  
 With one blade serrated  
 Con una lama zigrinata  
 Con una hoja dentada  
 Avec lame dentèle

**TC**

Super Cut

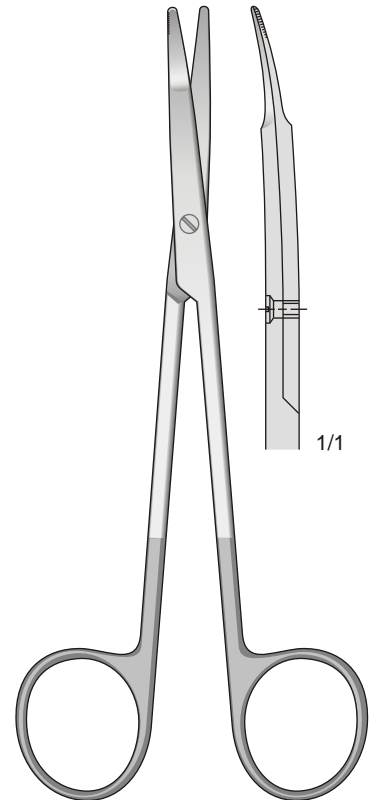
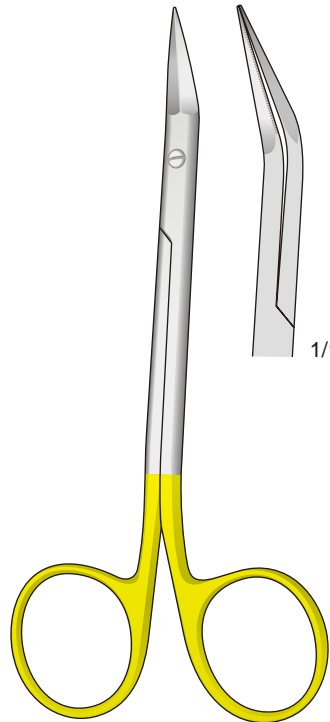
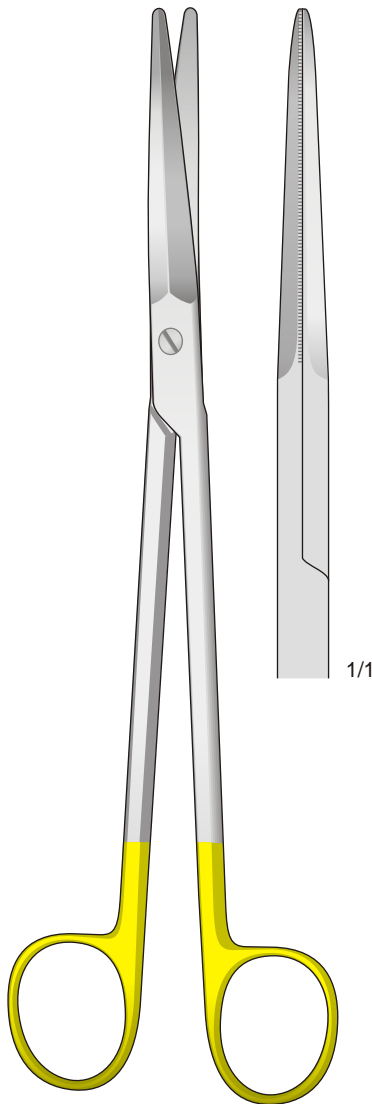
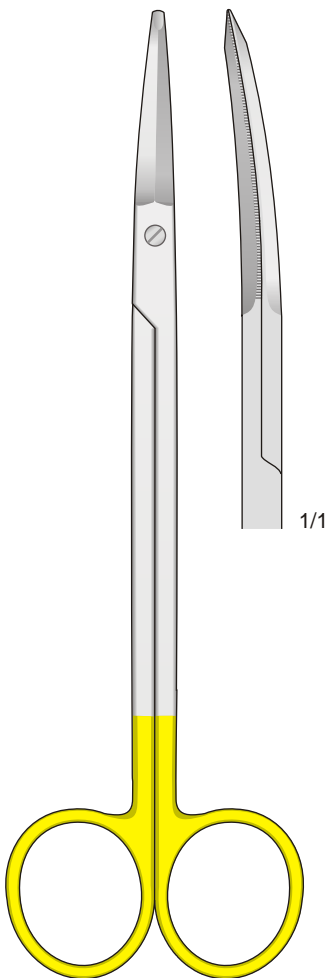

**FACE-LIFT**  
**FM-343**  
 180 mm

**GORNEY**  
**FM-344**  
 200 mm

**GIUNTA-NASAL**  
**FM-351**  
 130 mm

**KILNER**  
**FM-305**  
 150 mm

Mit Hartmetalleinsätzen - Tungsten-carbide scissors  
 Con punta al carburo di tungsteno - Tijeras de tungsteno - Avec plaquettes en carbure de tungstène

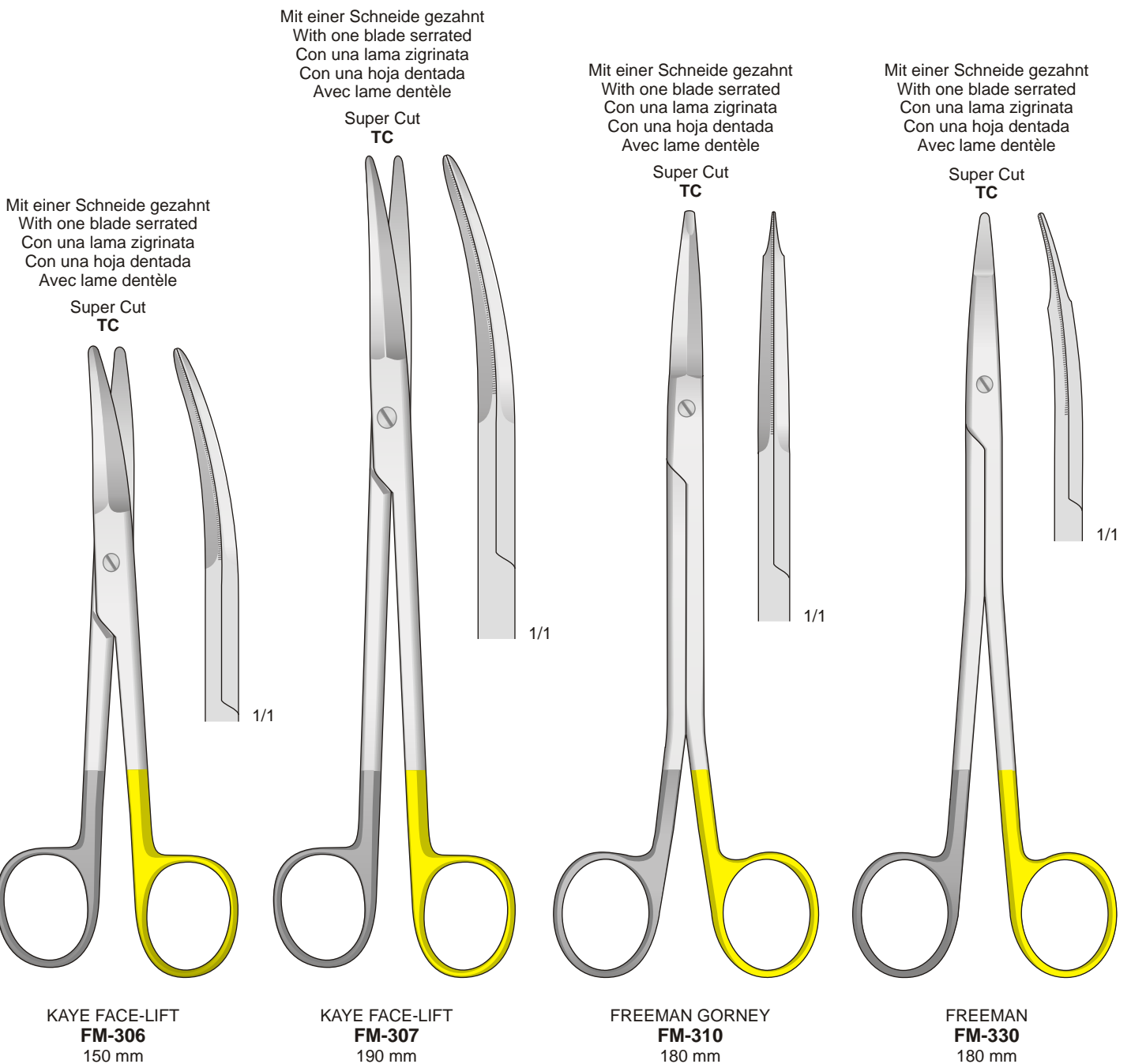

Mit Hartmetalleinsätzen  
Tungsten-carbide scissors  
Con punta al carburo di tungsteno  
Tijeras de tungsteno  
Avec plaquettes en carbure de tungstène

Mit einer Schneide gezahnt  
With one blade serrated  
Con una lama zigrinata  
Con una hoja dentada  
Avec lame dentèle

Super Cut  
**TC**

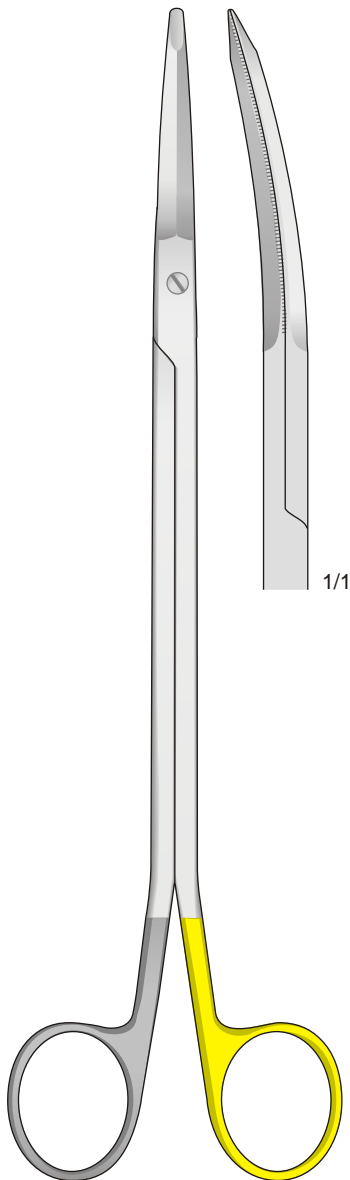

**GORNEY  
FM-331  
230 mm**

Mit einer Schneide gezahnt  
With one blade serrated  
Con una lama zigrinata  
Con una hoja dentada  
Avec lame dentèle

Super Cut

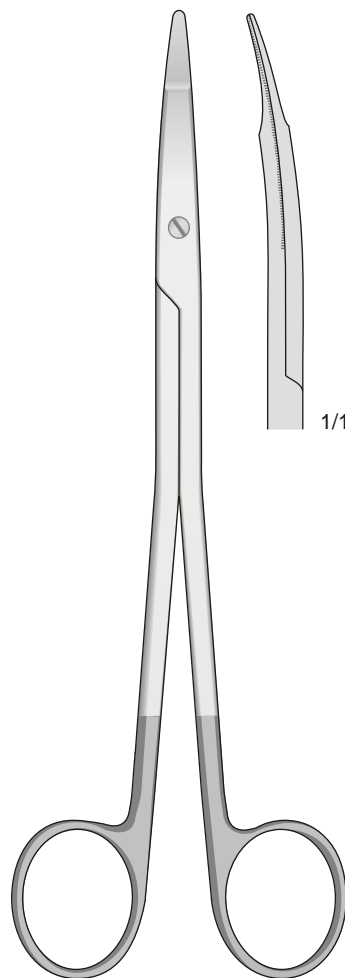

**FREEMAN  
FM-328  
180 mm**

Mit Hartmetalleinsätzen  
Tungsten-carbide scissors  
Con punta al carburo di tungsteno  
Tijeras de tungsteno  
Avec plaquettes en carbure de tungstène

Mit einer Schneide gezahnt  
With one blade serrated  
Con una lama zigrinata  
Con una hoja dentada  
Avec lame dentèle

Super Cut  
**TC**

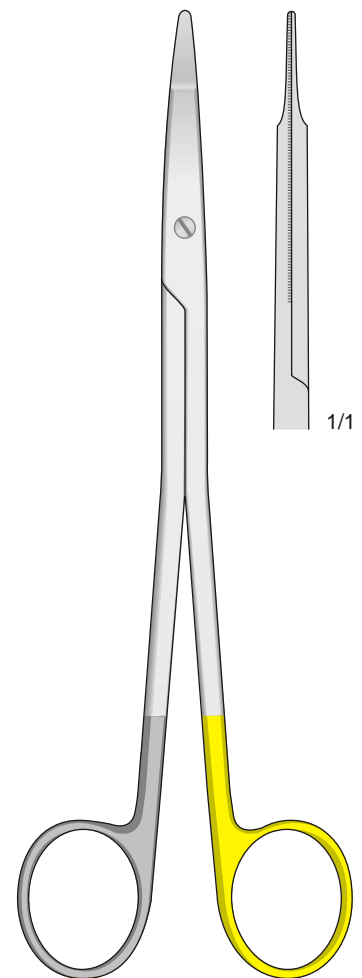

**FREEMAN  
FM-329  
180 mm**

Mit Hartmetalleinsätzen - Tungsten-carbide scissors  
 Con punta al carburo di tungsteno - Tijeras de tungsteno - Avec plaquettes en carbure de tungstène

Mit einer Schneide gezahnt  
 With one blade serrated  
 Con una lama zigrinata  
 Con una hoja dentada  
 Avec lame dentèle

Super Cut  
**TC**

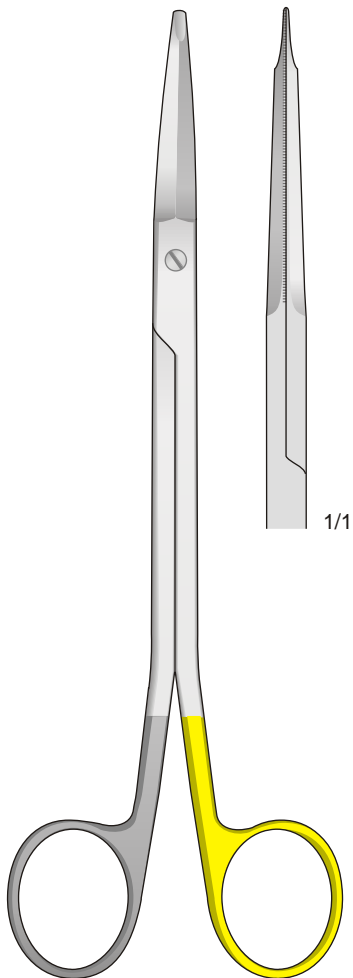

FREEMAN KAYE  
**FM-336**  
 180 mm

Mit einer Schneide gezahnt  
 With one blade serrated  
 Con una lama zigrinata  
 Con una hoja dentada  
 Avec lame dentèle

Super Cut  
**TC**

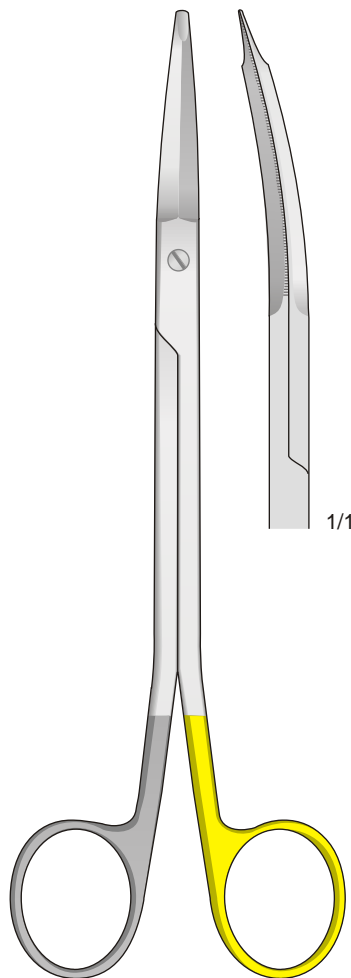

FREEMAN KAYE  
**FM-337**  
 180 mm

Mit einer Schneide gezahnt  
 With one blade serrated  
 Con una lama zigrinata  
 Con una hoja dentada  
 Avec lame dentèle

Super Cut  
**TC**

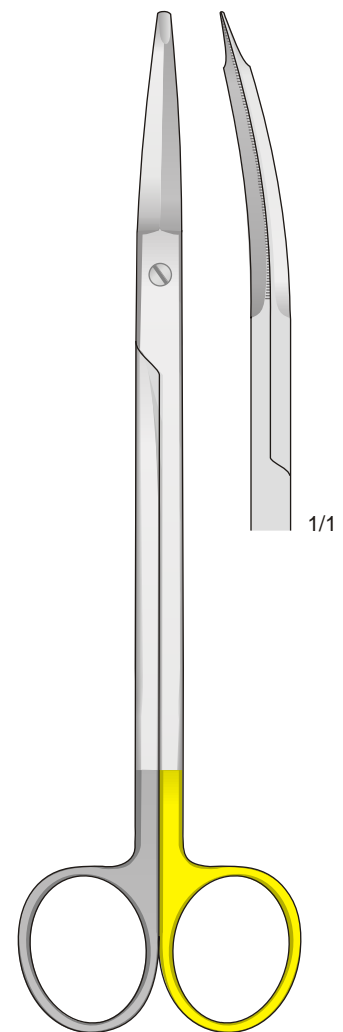

GORNEY  
**FM-324**  
 190 mm

Ligaturscheren

Ligature scissors

Forbici per suture

Tijeras para ligaduras

Ciseaux à ligatures

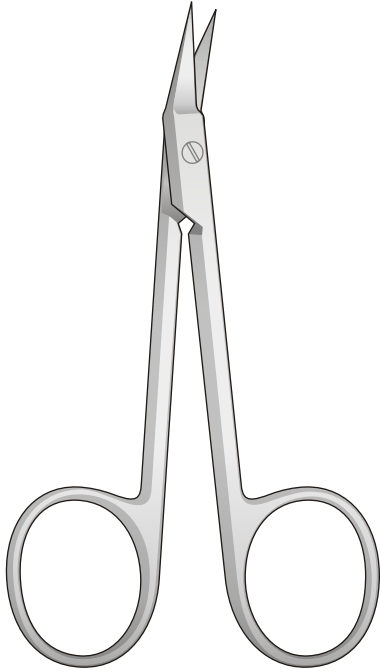

**O'BRIEN  
FG-151**  
95 mm

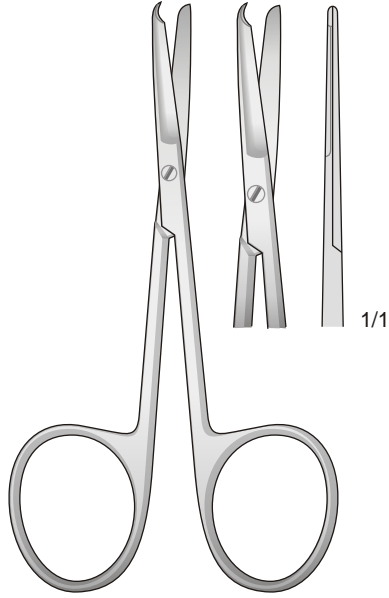

**SPENCER  
SC-9**  
90 mm

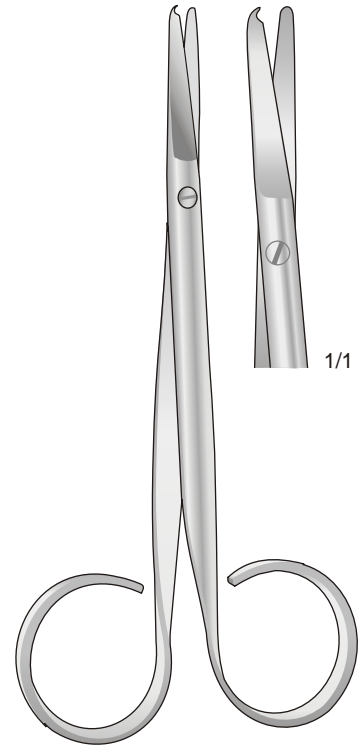

**SPENCER  
SC-1**  
110 mm

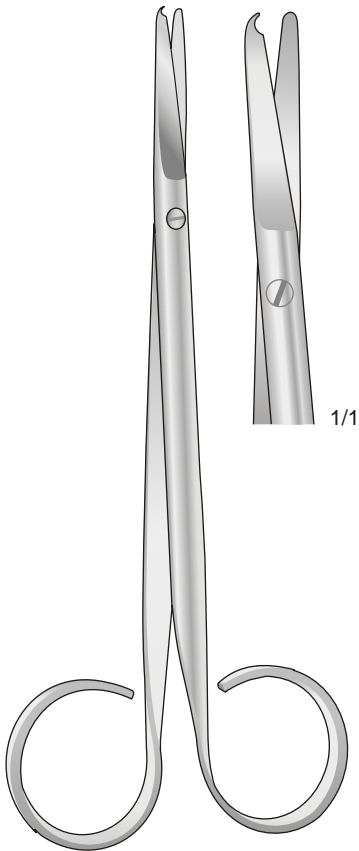

**SPENCER  
SC-2**  
145 mm

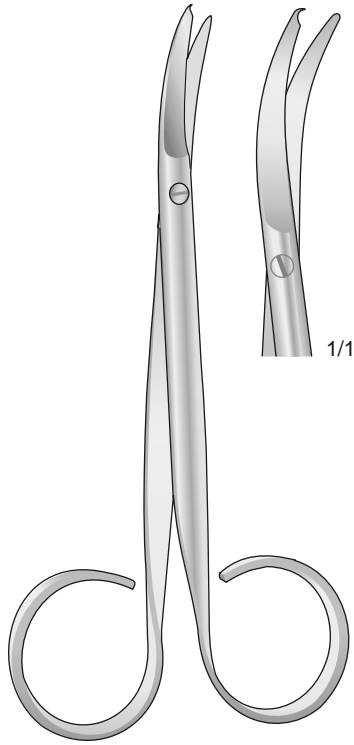

**SPENCER  
SC-5**  
110 mm

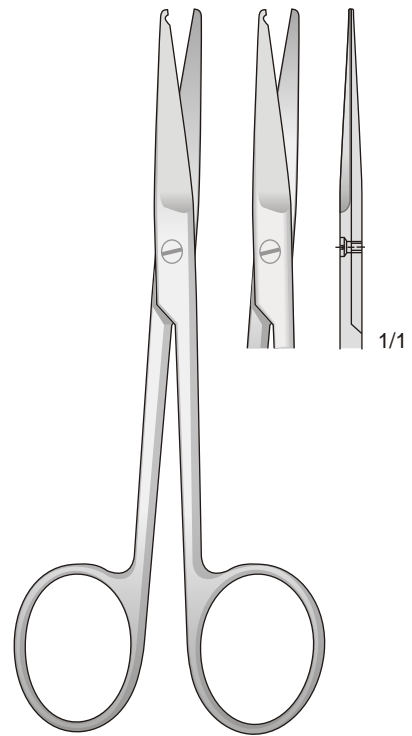

**SC-12**  
115 mm

Nagelscheren

Nail Scissors

Forbici per unghie

Tijeras para hojas

Ciseaux pour les ongles

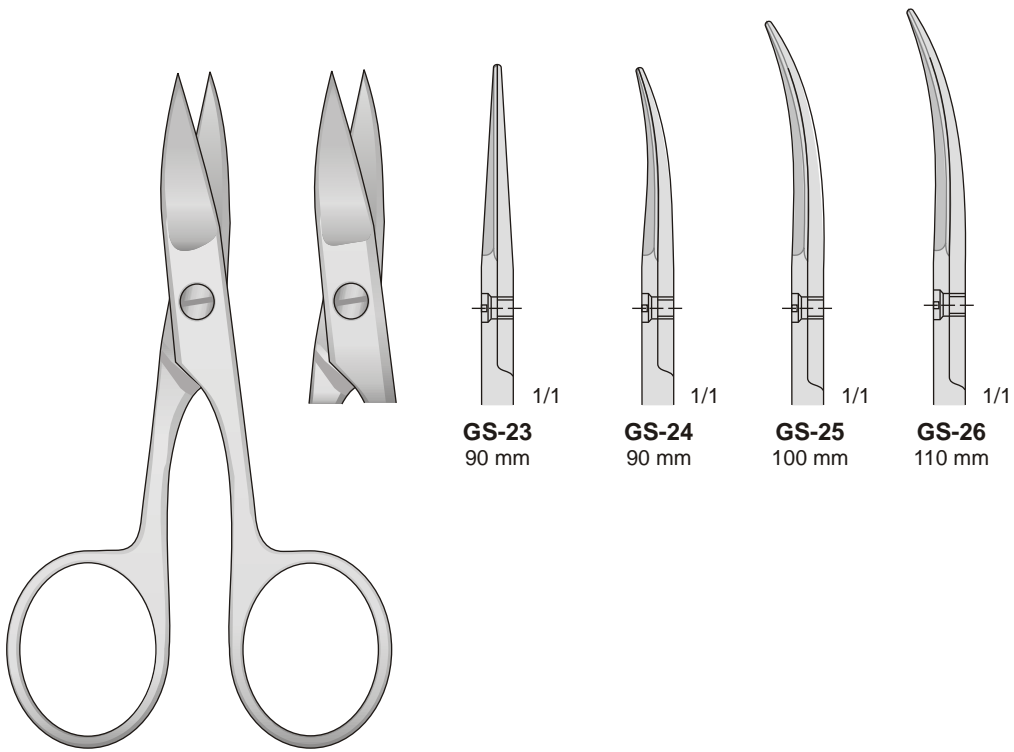

**GS-23**  
90 mm

**GS-24**  
90 mm

**GS-25**  
100 mm

**GS-26**  
110 mm

**GS-23/GS-26**

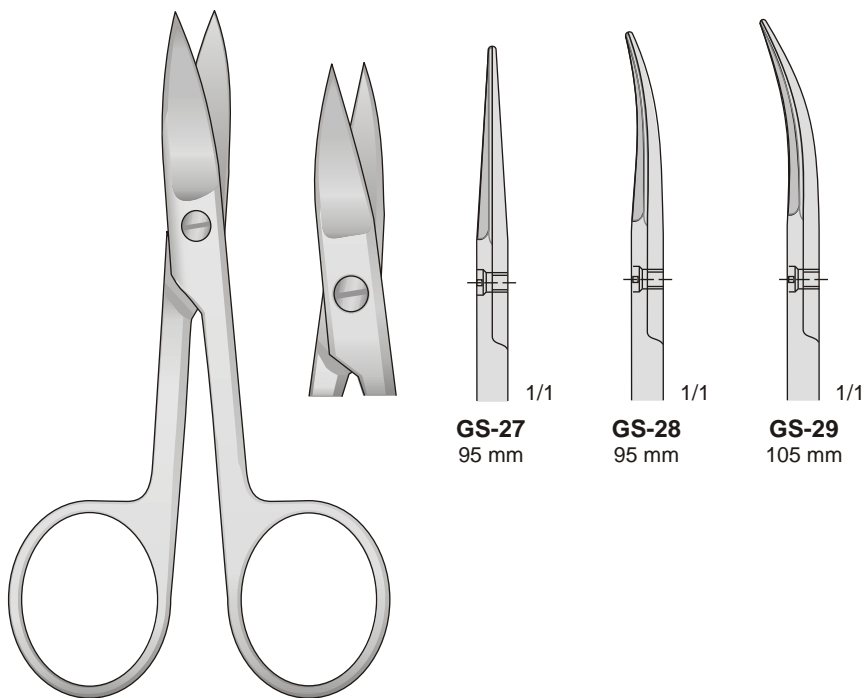

**GS-27**  
95 mm

**GS-28**  
95 mm

**GS-29**  
105 mm

**GS-27/GS-29**







**SADIQ SURGICAL CO.**

Catalogue 2015 / 2016



3

Pinzetten  
Tissue Forceps  
Pinzette  
Pinzas  
Pincas



Mikro Pinzetten

Delicate forceps

Micro pinzette

Pinzas finos

Micro pincers

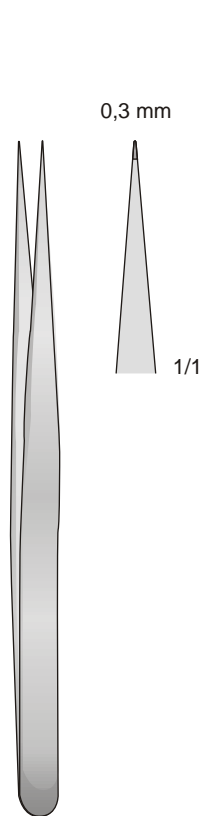

**BD-235**  
120 mm

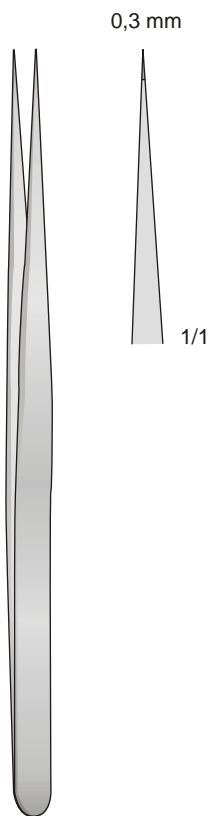

**BD-236**  
135 mm

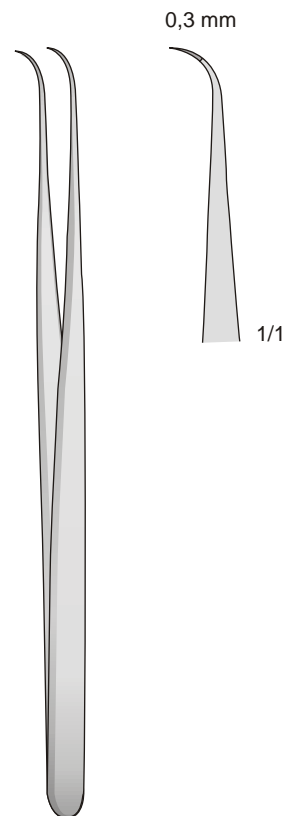

**BD-237**  
135 mm

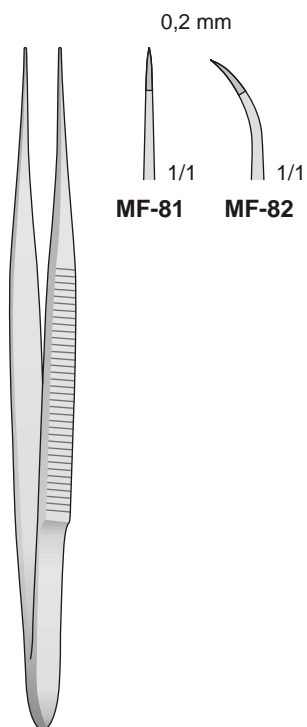

**MF-81/MF-82**  
125 mm

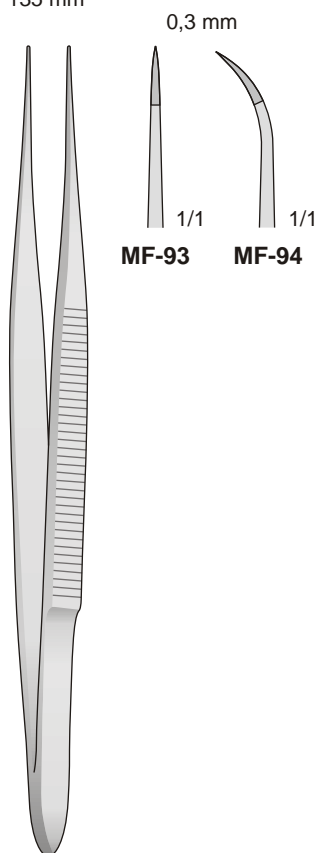

**MF-93/MF-94**  
150 mm

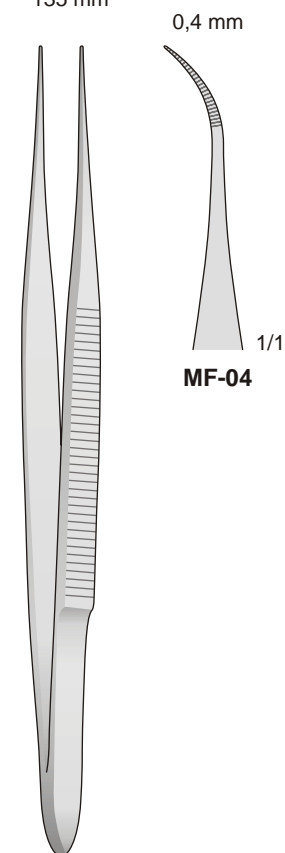

**MF-04**  
150 mm

Mikro Pinzetten

Delicate forceps

Micro pinzette

Pinzas finos

Micro pinces

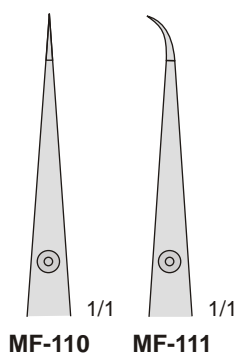
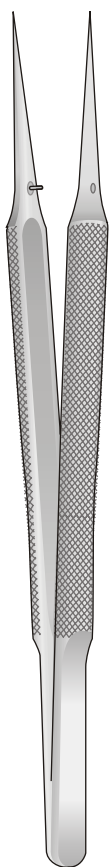

**MF-110/MF-111**  
120 mm

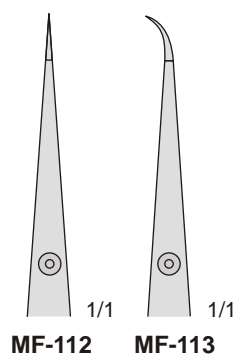
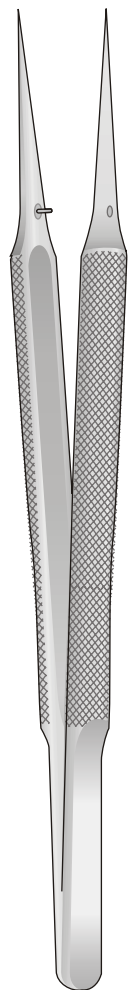

**MF-112/MF-113**  
150 mm

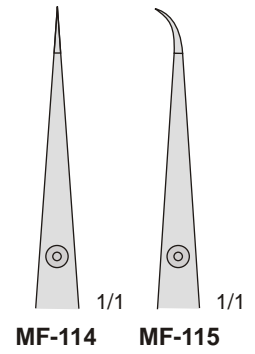
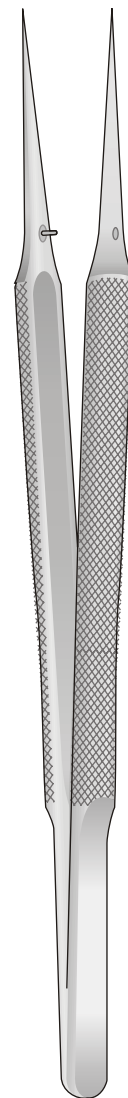

**MF-114/MF-115**  
180 mm

Mikro Pinzetten

Delicate forceps

Micro pinzette

Pinzas finos

Micro pincers

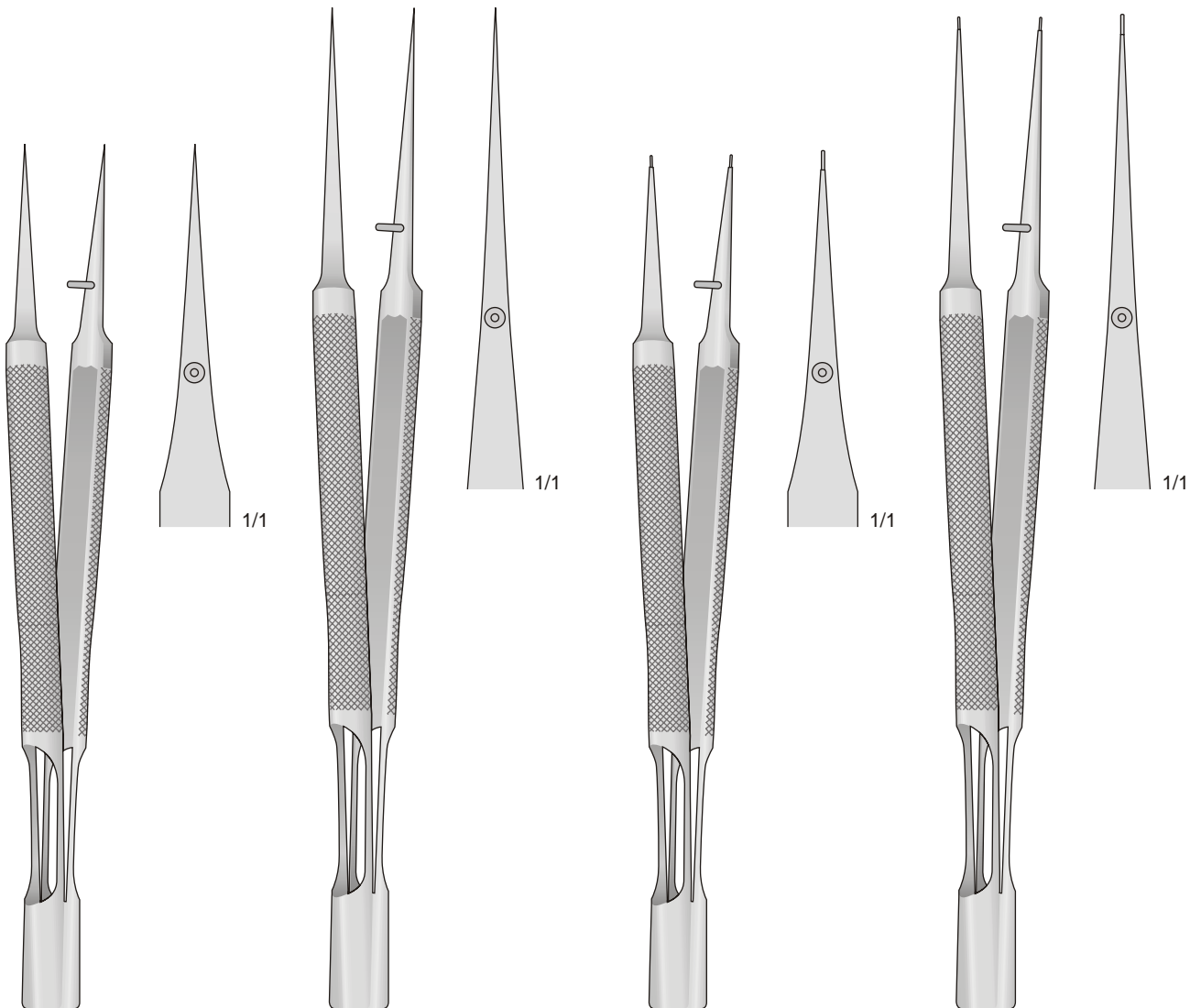
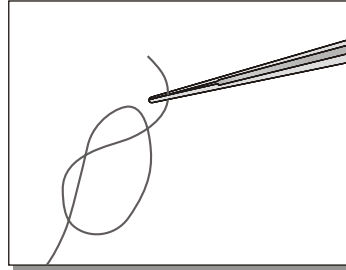

**BROCK  
FD-201**  
130 mm

**BROCK  
FD-202**  
150 mm

**BROCK  
FD-203**  
130 mm

**BROCK  
FD-204**  
150 mm

**Titan - Titanium - Titanio - Titane**

Mikro-Ringpinzette Ø 8 mm

Glatt - Smooth  
Liscia - Lisa  
Lisses

Gerieft - Serrated  
Zigrinata - Estriadas  
Stries

1 x 0,5 mm

1 x 0,5 mm

1/1

1/1

**MF-142T**  
150 mm

**MF-342T**  
150 mm

1 x 0,5 mm

1 x 0,5 mm

1/1

1/1

**MF-143T**  
180 mm

**MF-343T**  
180 mm

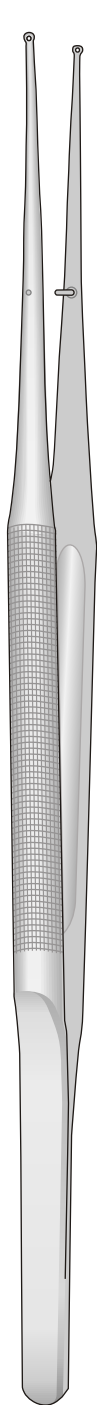

Ø 1 mm  
**MF-124** - 150 mm  
**MF-125** - 180 mm  
**MF-126** - 210 mm  
**MF-148** - 230 mm

Ø 2 mm  
**MF-127** - 150 mm  
**MF-128** - 180 mm  
**MF-129** - 210 mm  
**MF-149** - 230 mm

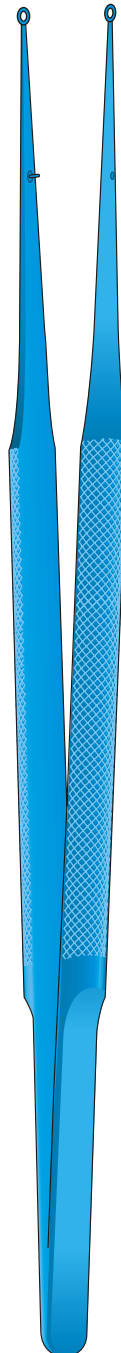

**MF-124/MF-149**

**MF-142T/MF-343T**

**Titan - Titanium - Titanio - Titane**

Mikro-Atrauma-Pinzette Ø 8 mm

Atrauma-Standard  
1,8 mm



1/1

**MF-354T**  
150 mm

Atrauma-Standard  
1,8 mm



1/1

**MF-355T**  
150 mm

Atrauma-Standard  
1,8 mm



1/1

**MF-356T**  
180 mm

Atrauma-Standard  
1,8 mm



1/1

**MF-357T**  
180 mm

Atrauma-Standard  
1,8 mm



1/1

**MF-358T**  
210 mm

Atrauma-Standard  
1,8 mm



1/1

**MF-359T**  
210 mm

Mikro-Knüpfpinzette Ø 8 mm

6 x 0,4 mm

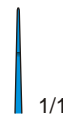

1/1

**MF-362T**  
150 mm

6 x 0,4 mm

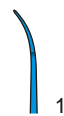

1/1

**MF-363T**  
150 mm

6 x 0,8 mm

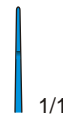

1/1

**MF-364T**  
180 mm

6 x 0,8 mm

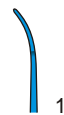

1/1

**MF-365T**  
180 mm

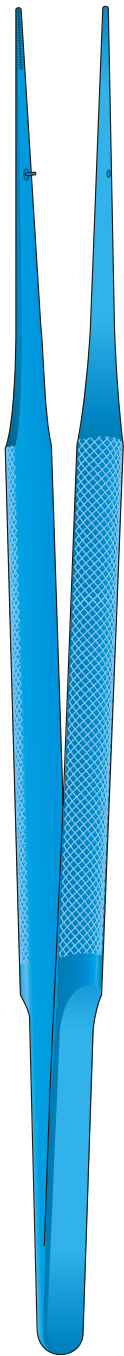

**MF-354T/MF-359T**

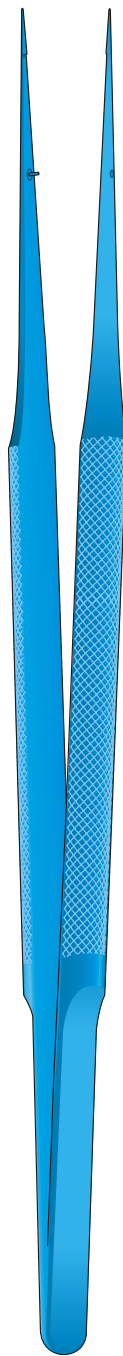

**MF-362T/MF-365T**

Mikro Pinzetten

Delicate forceps

Micro pinzette

Pinzas finos

Micro pincas

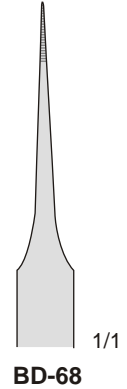
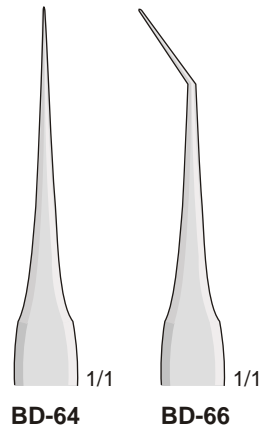
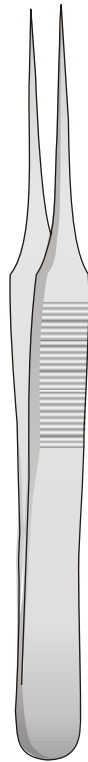
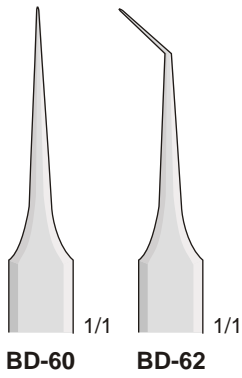
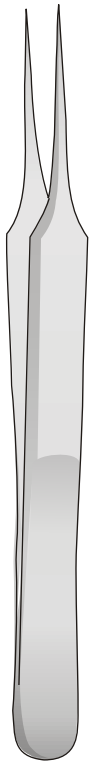

**BD-60/BD-62**  
110 mm

**BD-64/BD-66**  
110 mm

**BD-68**  
90 mm

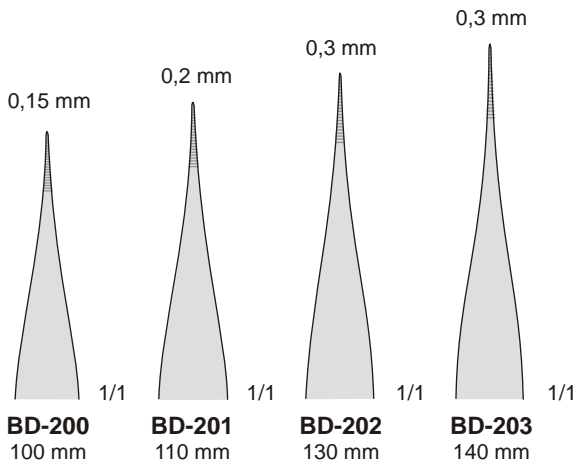
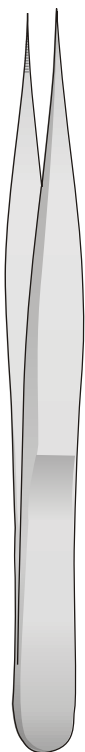

**BD-200/BD-203**

**BD-205**  
115 mm

**BD-206**  
115 mm



Feine Pinzetten

Delicate forceps

Pinzette delicate

Pinzas delicadas

Pincas d elicates

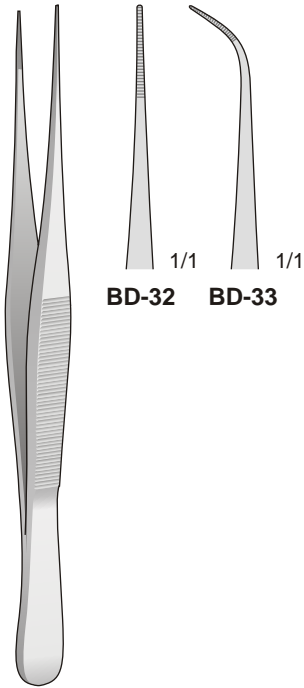

**BD-32** **BD-33**

**BD-32/BD-33**  
100 mm

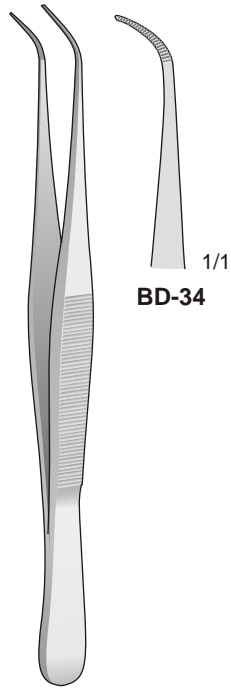

**BD-34**

**BD-34**  
100 mm

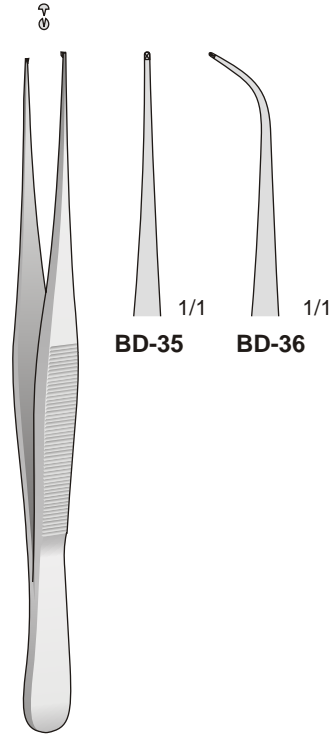

**BD-35** **BD-36**

**BD-35/BD-36**  
100 mm

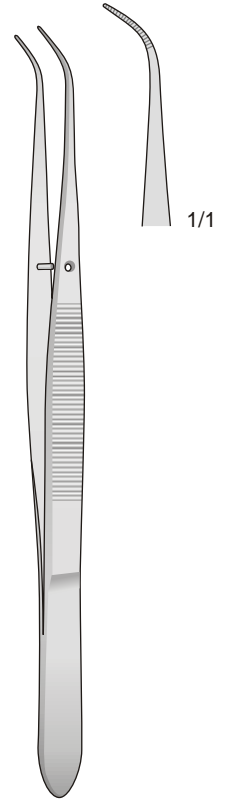

**PERRY**  
**BD-05**  
125 mm

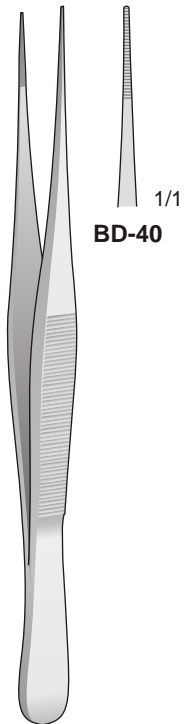

**BD-40**

**BD-40**  
110 mm

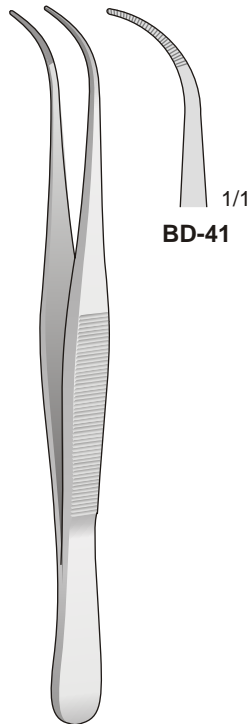

**BD-41**

**BD-41**  
110 mm

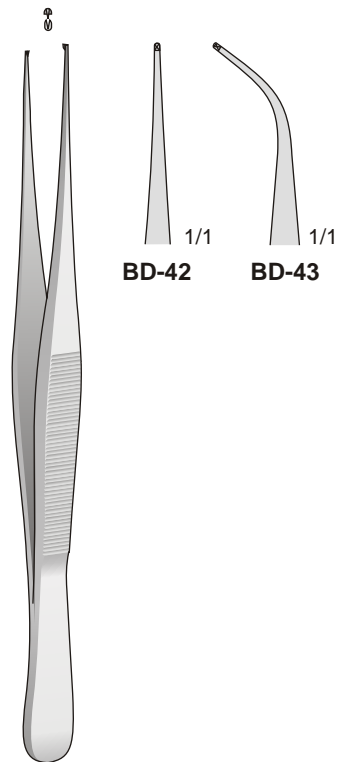

**BD-42** **BD-43**

**BD-42/BD-43**  
110 mm

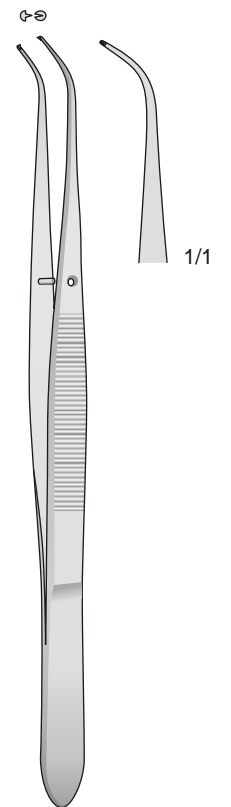

**PERRY**  
**BD-06**  
125 mm

Chirurgische Pinzetten

Tissue forceps

Pinzette chirurgiche

Pinzas quirúrgicas

Pinces chirurgicales



**BD-56/BD-59**  
100 mm

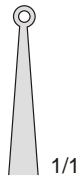

**BD-56**  
1/1

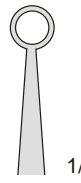

**BD-57**  
1/1

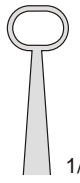

**BD-58**  
1/1



**BD-59**  
1/1



1x2 denti  
0,2 mm  
1/1  
**BD-238**  
95 mm

**BD-238**  
95 mm

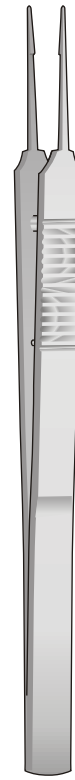

**AUSTIN**  
**BD-239**  
140 mm

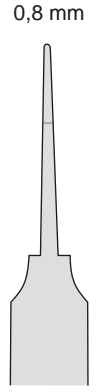

1/1



**GRAEFE**  
**BD-04/BD-96**  
100 mm

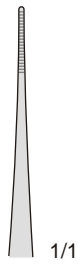

**BD-04**  
1/1

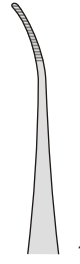

**BD-96**  
1/1

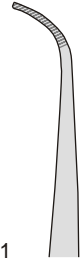

**BD-07**  
1/1



**GRAEFE**  
**BD-194/BD-196**  
100 mm

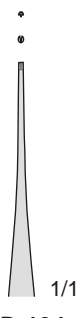

**BD-194**  
1/1



**BD-195**  
1/1

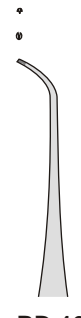

**BD-196**  
1/1

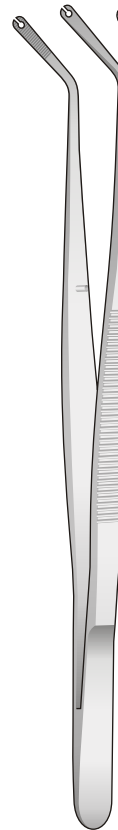

**CORN**  
**DA-07**  
150 mm

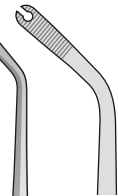

1/1

Chirurgische Pinzetten

Tissue forceps

Pinzette chirurgiche

Pinzas quirúrgicas

Pincas chirurgicales

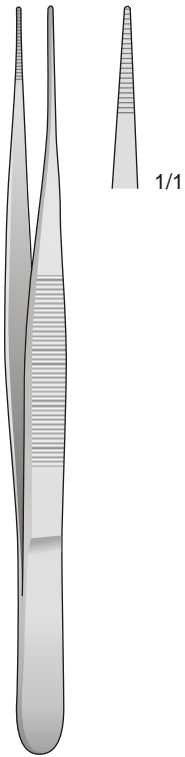

**BD-145**  
130 mm

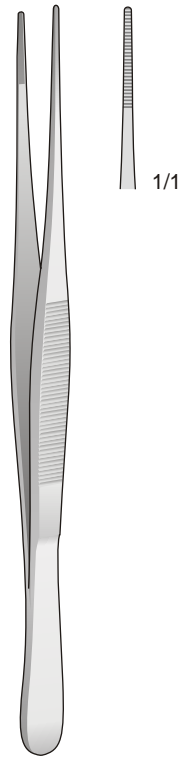

**SEMKEN  
BD-44**  
130 mm

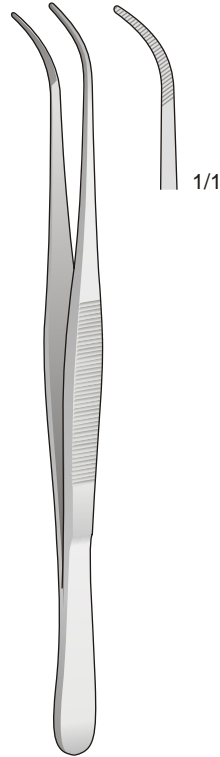

**SEMKEN  
BD-45**  
130 mm

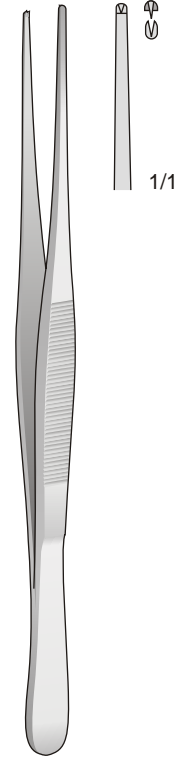

**SEMKEN  
BD-46**  
130 mm

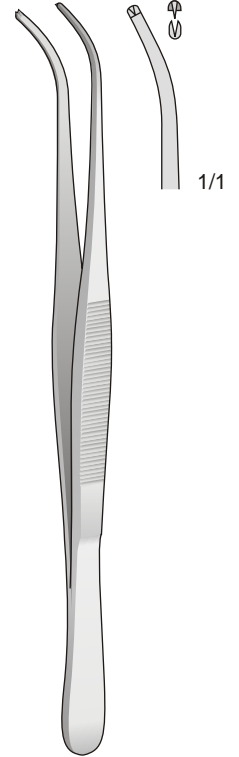

**SEMKEN  
BD-47**  
130 mm

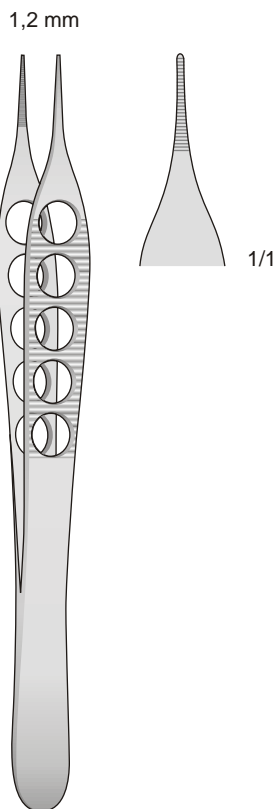

**ADSON  
BD-207**  
120 mm

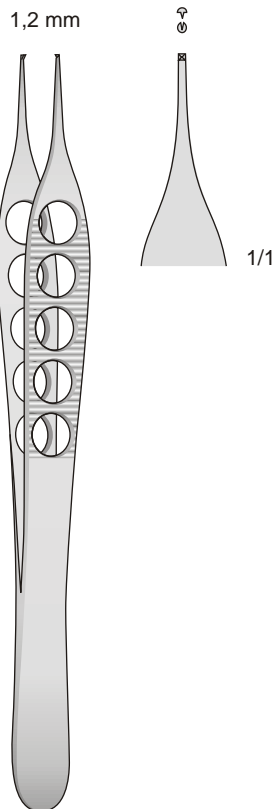

**ADSON  
BD-208**  
120 mm

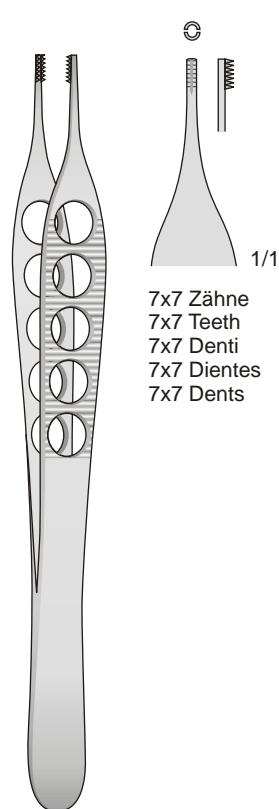

**ADSON-BROWN  
BD-209**  
120 mm

7x7 Zähne  
7x7 Teeth  
7x7 Denti  
7x7 Dientes  
7x7 Dents

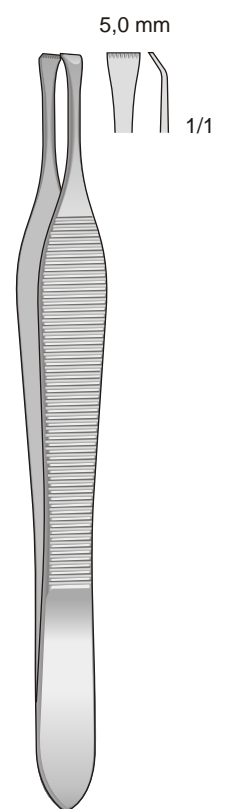

**BEASLEY-BABCOCK  
BD-51**  
120 mm

Chirurgische Pinzetten

Tissue forceps

Pinzette chirurgiche

Pinzas quirúrgicas

Pincas chirurgicales

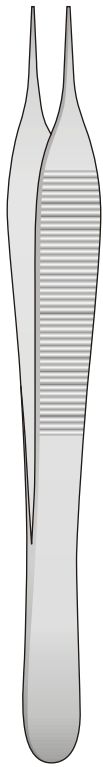

ADSON  
**BD-30/BD-73**

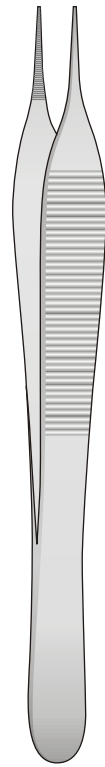
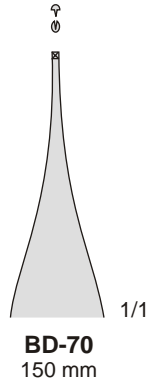
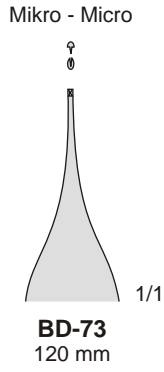
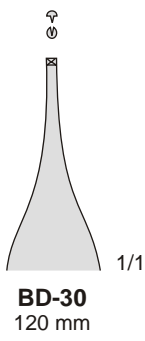

ADSON  
**BD-31/BD-72**

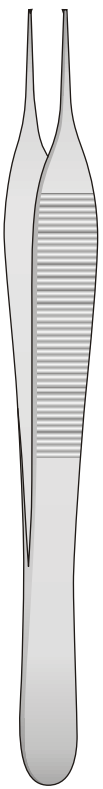
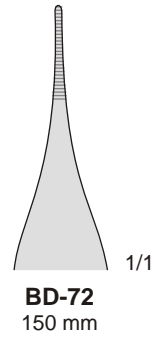
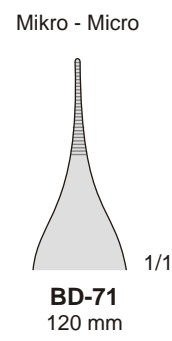
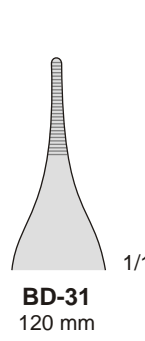

ADSON  
**BD-177/BD-178**  
150 mm

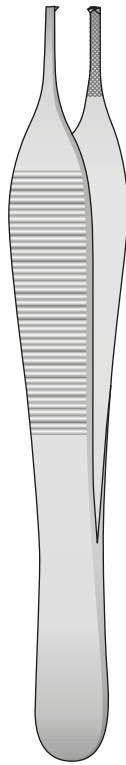
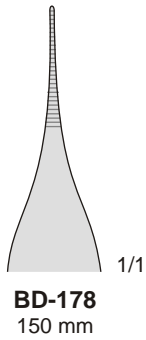
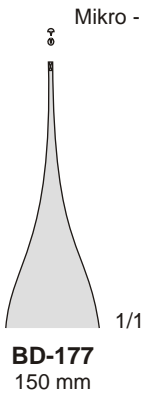

ADSON  
**BD-90**  
120 mm

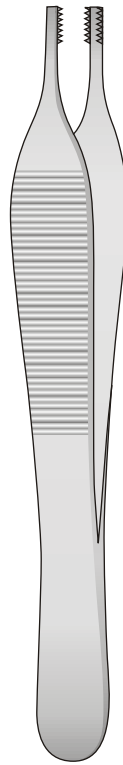
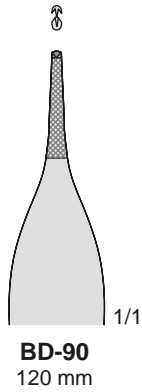

ADSON-BROWN  
**BD-92/BD-141**  
120 mm

6x6 Zähne  
6x6 Teeth  
6x6 Denti  
6x6 Dientes  
6x6 Dents

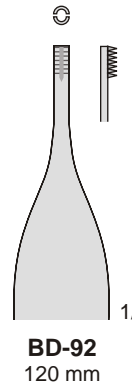

9x9 Zähne  
9x9 Teeth  
9x9 Denti  
9x9 Dientes  
9x9 Dents

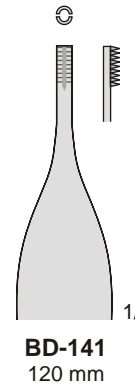

6x6 Zähne  
6x6 Teeth  
6x6 Denti  
6x6 Dientes  
6x6 Dents

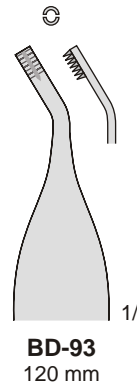

Anatomische Pinzetten

Dressing forceps

Pinzette anatomiche

Pinzas anatómicas

Pinces anatomiques

Standard

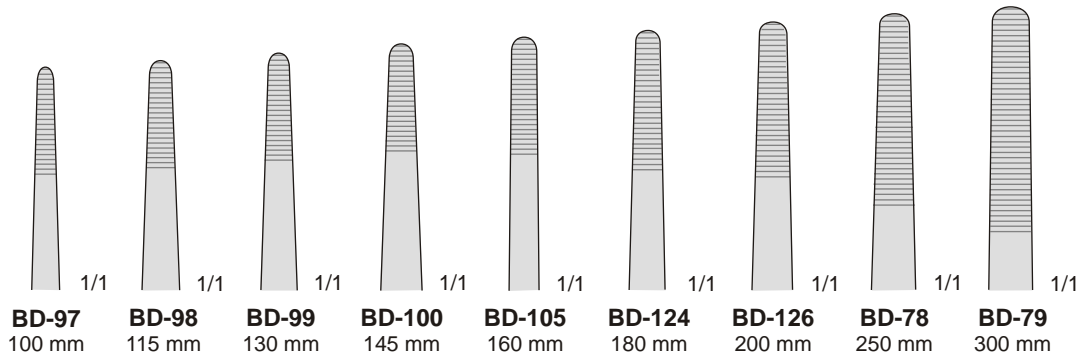

BD-78/BD-126



Mod. Fine

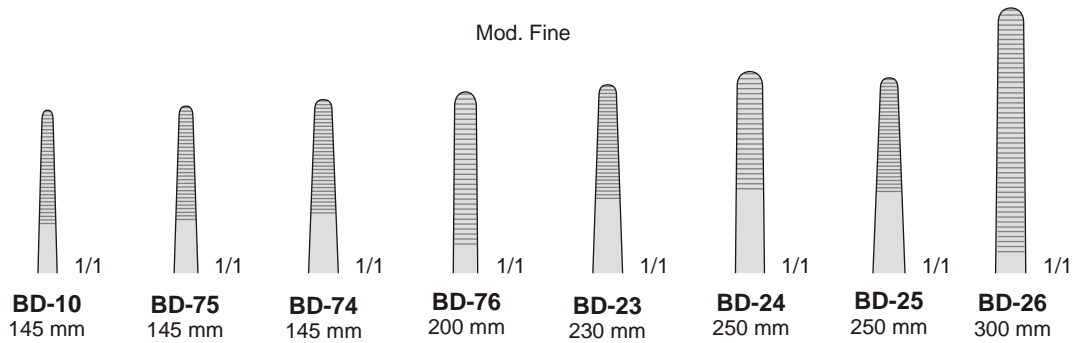

BD-10/BD-76

Anatomische Pinzetten

Dressing forceps

Pinzette anatomiche

Pinzas anatómicas

Pinces anatomiques

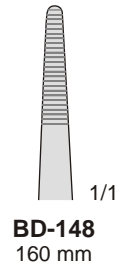
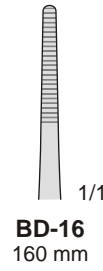
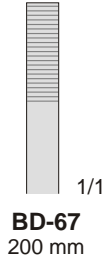
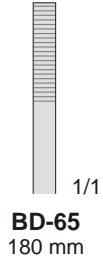
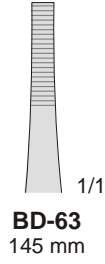
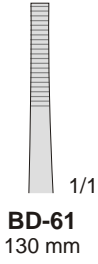

STILLE  
BD-61/BD-67

BD-16/BD-148  
160 mm

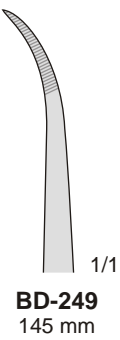
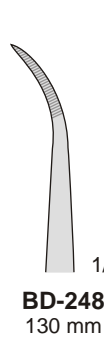
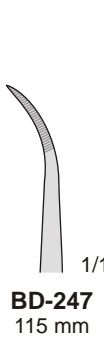
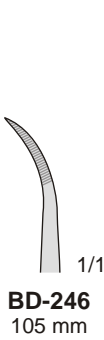
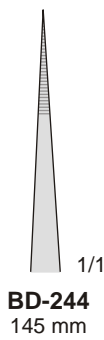
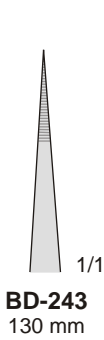
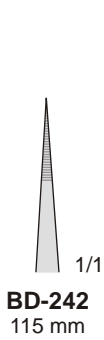
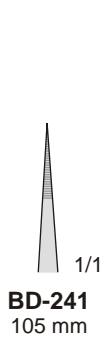

BD-240/BD-249

Chirurgische Pinzetten

Tissue forceps

Pinzette chirurgiche

Pinzas quirúrgicas

Pinces chirurgicales

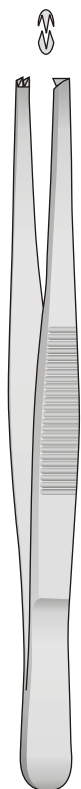

1x2 Zähne  
1x2 Teeth  
1x2 Denti  
1x2 Dientes  
1x2 Dents

Standard

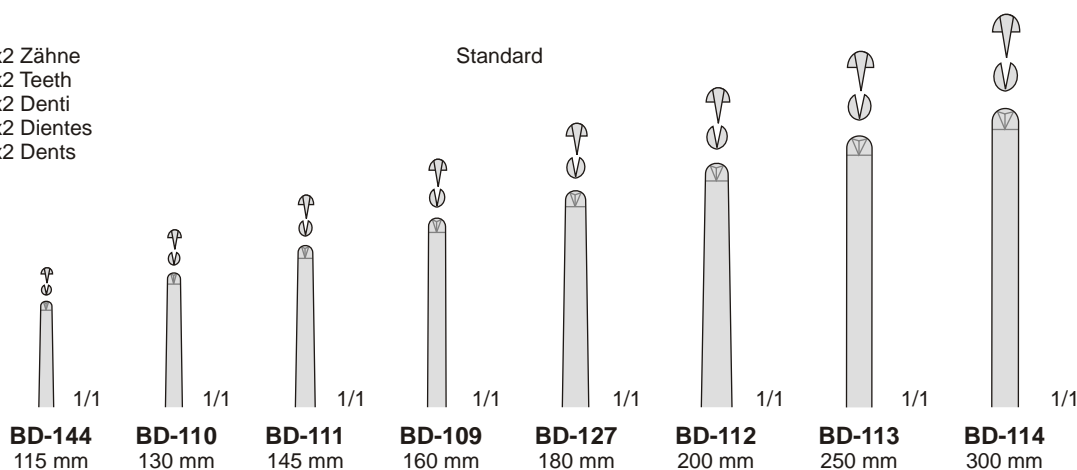

**BD-109/BD-144**



1x2 Zähne  
1x2 Teeth  
1x2 Denti  
1x2 Dientes  
1x2 Dents

Schmal - Narrow - Strette - Estrechas - Étroites

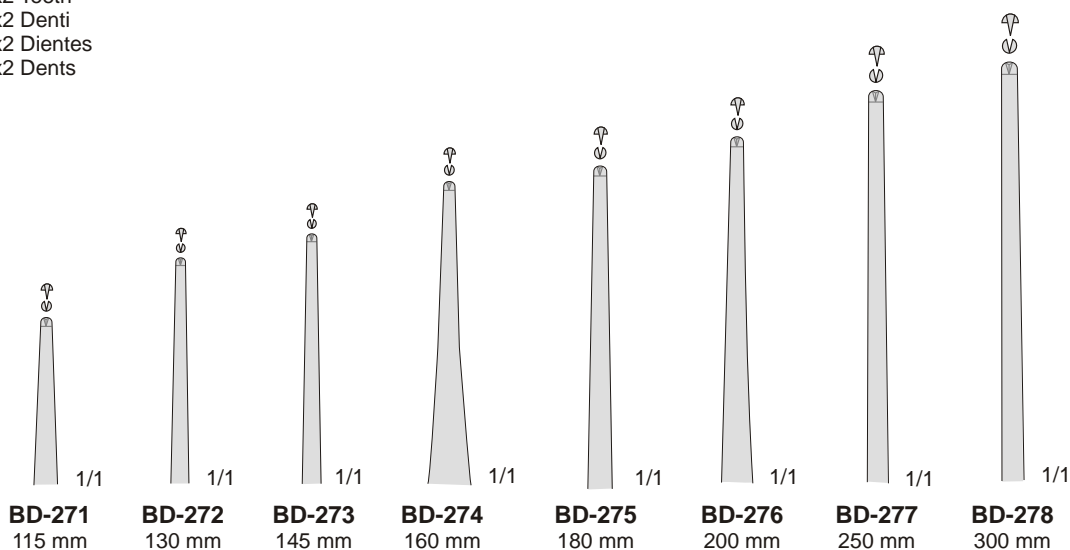

**BD-271/BD-278**

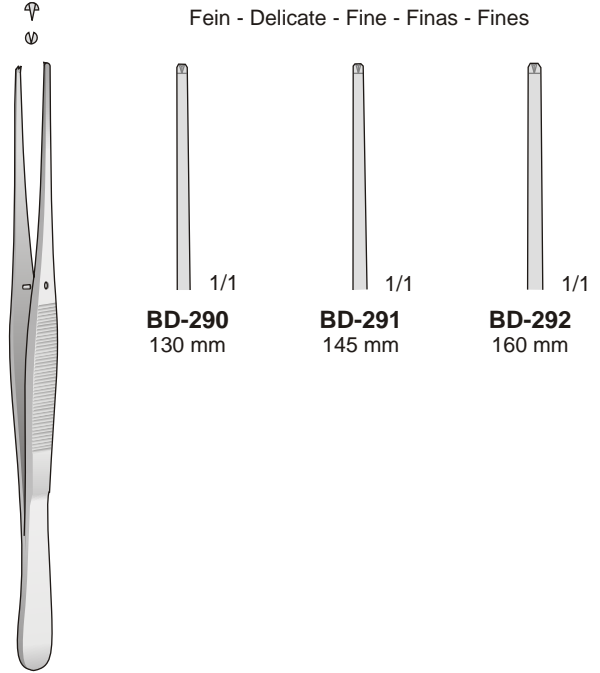
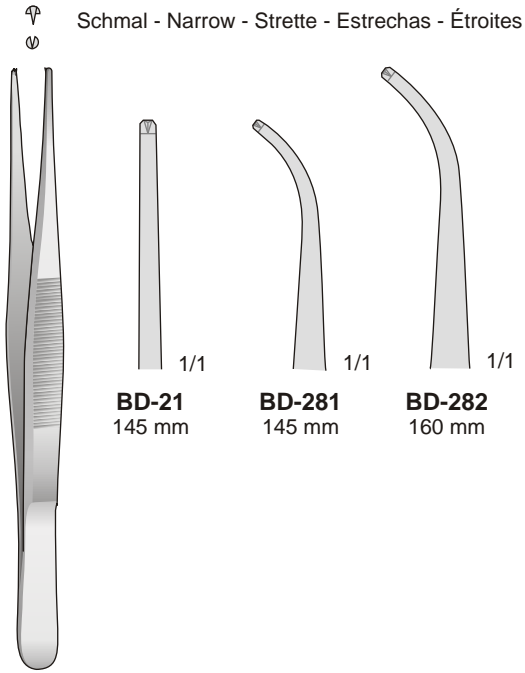

**BD-21/BD-282**

- 1 x 2 Zähne
- 1 x 2 Teeth
- 1 x 2 Denti
- 1 x 2 Dientes
- 1 x 2 Dents

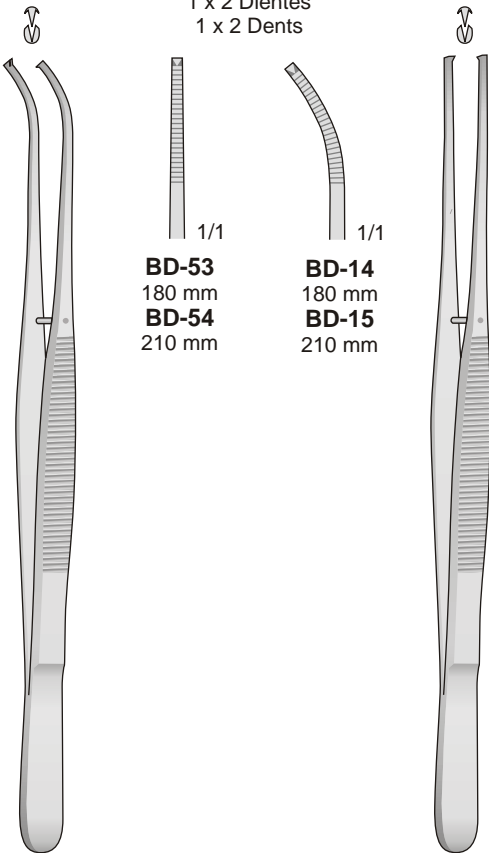

**POTTS-SMITH**  
**BD-14/BD-54**

**BD-290/BD-292**

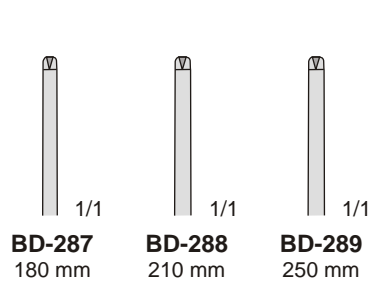

**POTTS-SMITH**  
**BD-287/BD-289**

- 1 x 2 Zähne
- 1 x 2 Teeth
- 1 x 2 Denti
- 1 x 2 Dientes
- 1 x 2 Dents

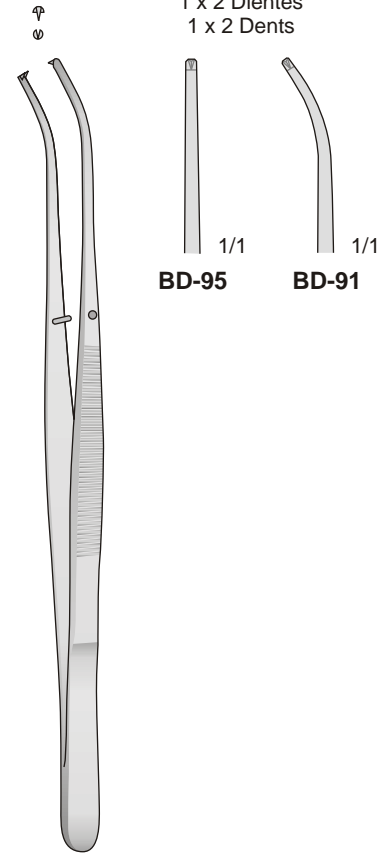

**SEMKEN**  
**BD-91/BD-95**  
150 mm



Chirurgische Pinzetten

Tissue forceps

Pinzette chirurgiche

Pinzas quirúrgicas

Pinces chirurgicales

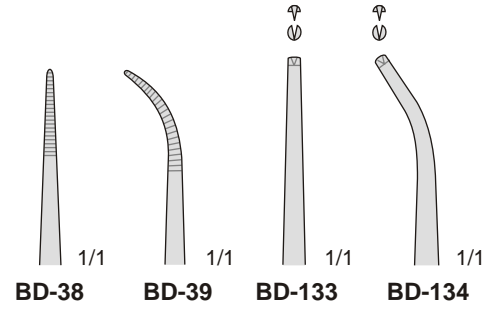
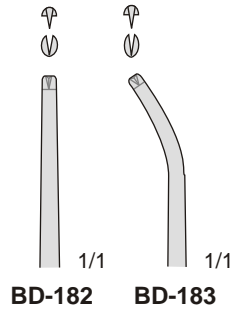
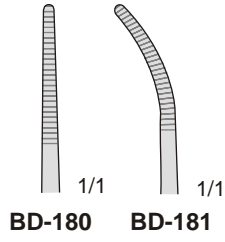

**CUSHING**  
**BD-180/BD-181**  
175 mm

**CUSHING**  
**BD-182/BD-183**  
175 mm

**BD-38/BD-134**  
200 mm

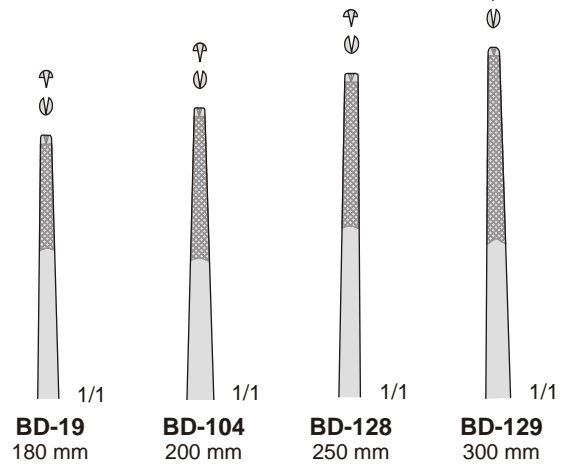
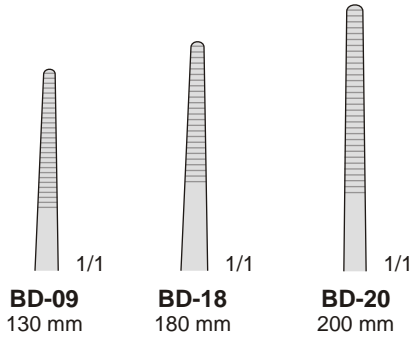

**BD-09/BD-20**

**BD-19/BD-129**

2 x 3 Zähne - 2 x 3 Teeth - 2 x 3 Denti  
2 x 3 Dientes - 2 x 3 Dents

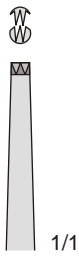

**BD-106**  
115 mm

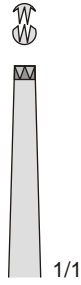

**BD-138**  
145 mm

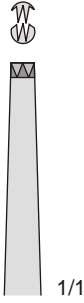

**BD-107**  
160 mm

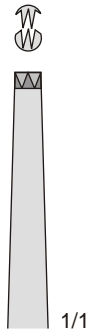

**BD-139**  
180 mm

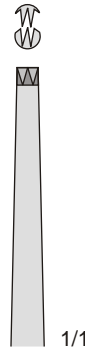

**BD-108**  
200 mm

**BD-106/BD-139**

3 x 4 Zähne - 3 x 4 Teeth - 3 x 4 Denti  
3 x 4 Dientes - 3 x 4 Dents

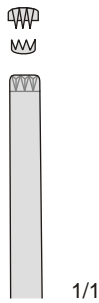

**BD-115**  
145 mm



**BD-119**  
160 mm

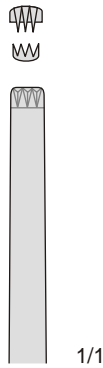

**BD-116**  
200 mm

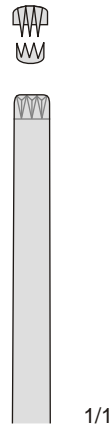

**BD-117**  
250 mm

4 x 5 Zähne  
4 x 5 Teeth  
4 x 5 Denti  
4 x 5 Dientes  
4 x 5 Dents

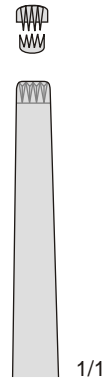
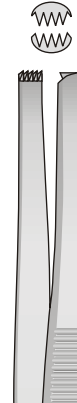

**BD-118**  
145 mm

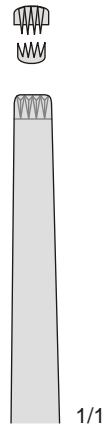

**BD-149**  
160 mm

**BD-115/BD-119**

**BD-118/BD-149**

Chirurgische Pinzetten

Tissue forceps

Pinzette chirurgiche

Pinzas quirúrgicas

Pinces chirurgicales

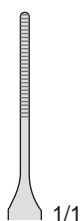

**GERALD  
MF-101**  
180 mm

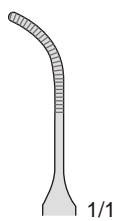
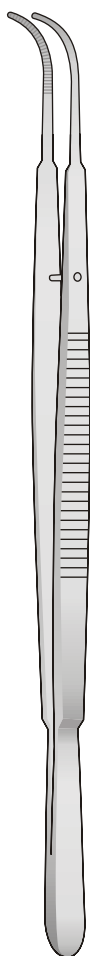

**GERALD  
MF-102**  
180 mm

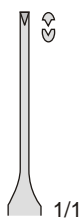

**GERALD  
MF-103**  
180 mm

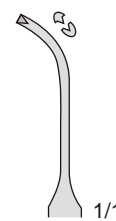

**GERALD  
MF-104**  
180 mm

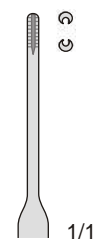

**GERALD-BROWN  
MF-105**  
180 mm

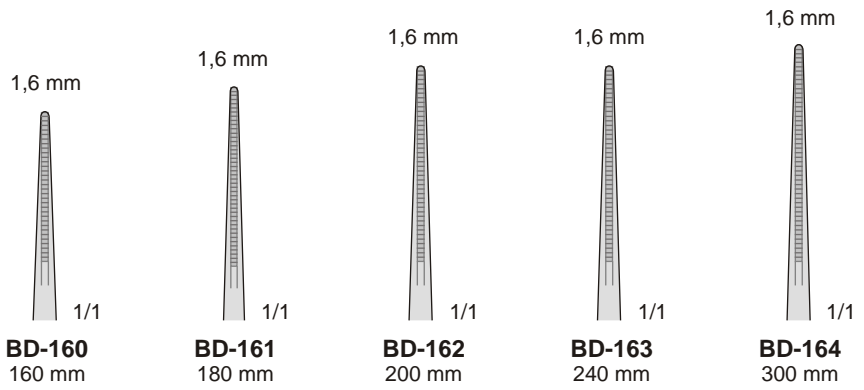

Atraumatische Pinzetten  
Atraumatic Forceps  
Pinzette atraumatiche  
Pinzas atraumáticas  
Pinces atraumatiques

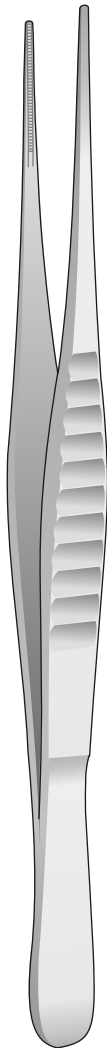

DE BAKEY  
**BD-80/BD-164**

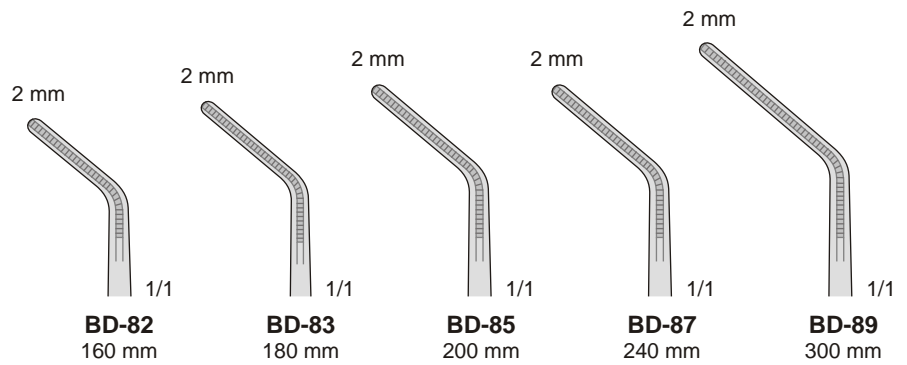
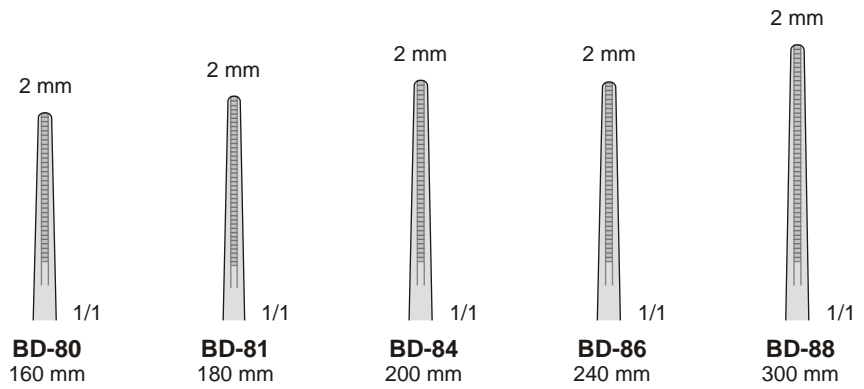

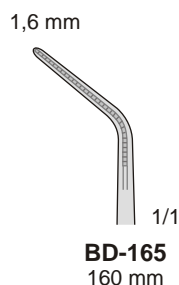

Atraumatische Pinzetten  
Atraumatic Forceps  
Pinzette atraumatiche  
Pinzas atraumáticas  
Pinces atraumatiques



DE BAKEY  
**BD-165/BD-173**

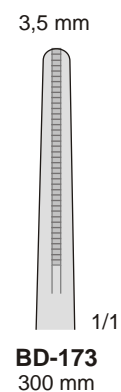
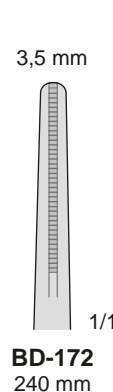
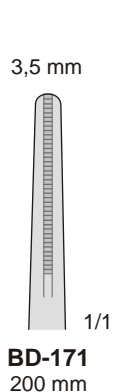
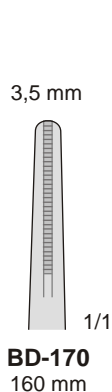
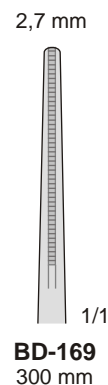
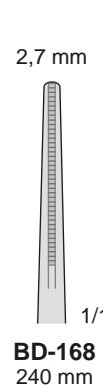
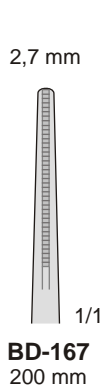
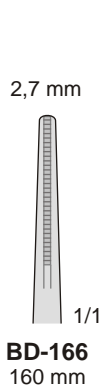

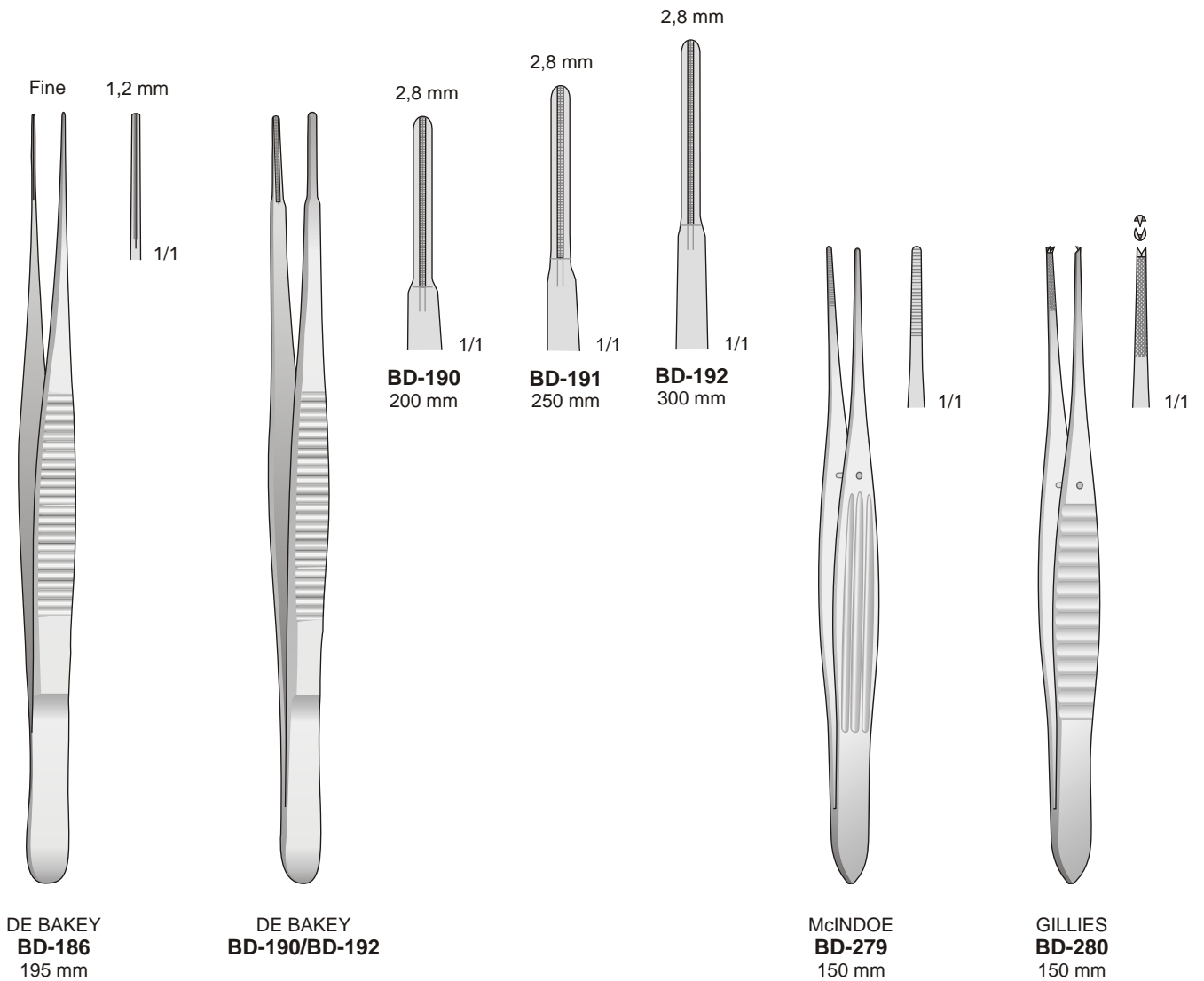

Mikro Pinzetten

Delicate forceps

Micro pinzette

Pinzas finos

Micro pincas

Fixier und Fasspinzetten - Fixation and Grasping forceps  
 Pinze da Fissazione - Pinzas de fijación y de aprehensión  
 Pincas pour saisir les tissus

Columella-Klemmen - Columella forceps  
 Pinzetta-Columella con stop - Pinzas para Columella  
 Pincas pour Columelle

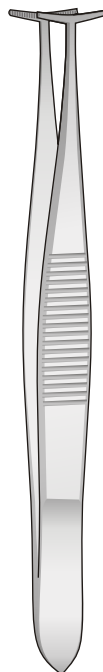

BD-333

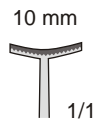

BD-334

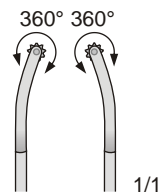
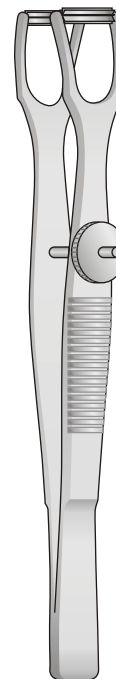

GRAEFE  
BD-135  
110 mm

GRAEFE  
BD-136  
110 mm

GREEN  
BD-333/BD-334  
100 mm

COTTLE  
BD-140  
100 mm

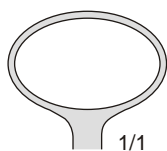
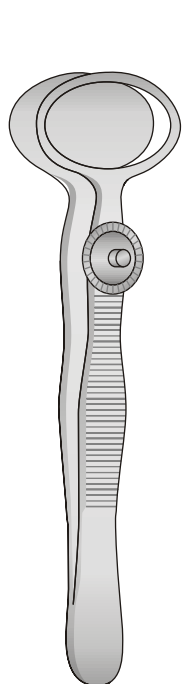
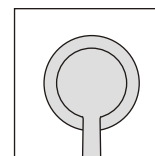
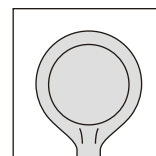
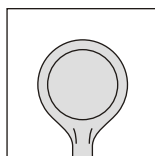

BD-130  
20 mm

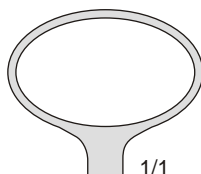

BD-131  
26 mm

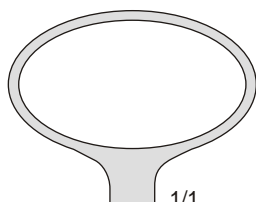

BD-132  
31 mm

DESMARRES  
BD-130/BD-132  
90 mm

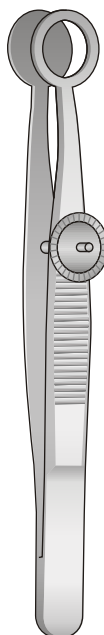

LAMBERT  
BD-260  
90 mm



HUNT  
BD-261  
95 mm

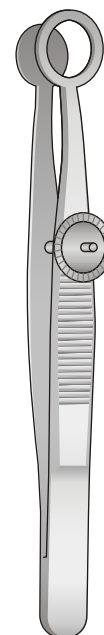

AYERS  
BD-263  
90 mm

Chirurgische Pinzetten

Tissue forceps

Pinzette chirurgiche

Pinzas quirúrgicas

Pinces chirurgicales

Dressing Forceps  
criss-cross serrated tips

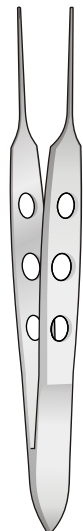
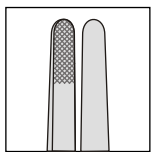

**BISHOP-HARMON**  
**MF-175**  
85 mm

Tissue Forceps  
1x2 Teeth

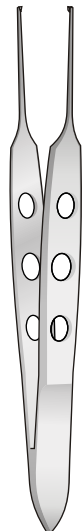
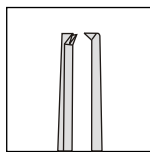

**BISHOP-HARMON**  
**MF-176** 0,3 mm  
**MF-177** 0,6 mm  
85 mm

Iris Forceps  
serrated jaws

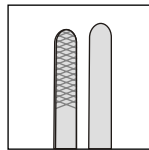

**GRAEFE**  
**MF-178** Straight  
**MF-179** Curved  
65 mm

Iris Forceps  
1x2 Teeth

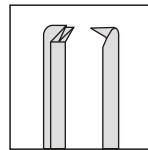

**GRAEFE**  
**MF-180** Straight  
**MF-181** Curved  
65 mm

Micro Iris Forceps  
straight, ultra fine shanks  
with 1x2 teeth, 0,12 mm

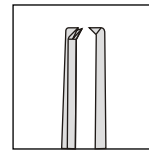

**BONN**  
**MF-182** 75 mm

Ultra fine 5 mm  
Straight

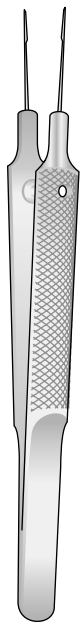
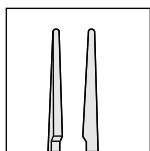

**MF-150**  
100 mm

Suturing Forceps  
1x2 teeth of 0,12 mm set at 90°,  
extra delicate platform

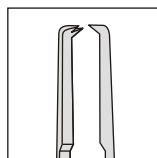

**TENNANT**  
**MF-230**  
100 mm

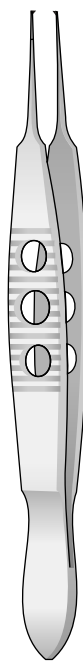
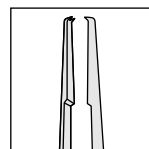

**MC PHERSON**  
**MF-235**  
105 mm

1x2 curved teeth

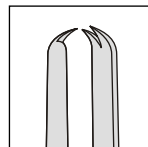

**KUHNT**  
**BD-255**  
110 mm

1x2 angular teeth

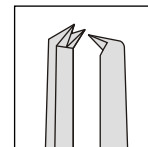

**ELSCHNIG**  
**BD-256** 0,6 mm  
105 mm



Chirurgische Pinzetten

Tissue forceps

Pinzette chirurgiche

Pinzas quirúrgicas

Pinces chirurgicales

Mit Hartmetalleinsätzen - Tungsten-carbide forceps  
 Con punta al carburo di tungsteno - Pinzas con tungsteno  
 Avec plaquettes en carbure de tungstène

Pinzette mit Häkchen  
 Suturing Forceps  
 Pinzette per sutura

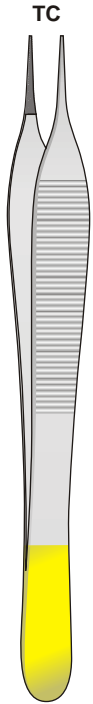

ADSON  
BD-230/BD-231

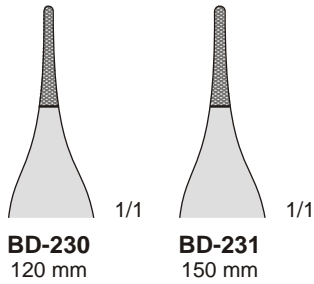

ADSON  
BD-250/BD-251

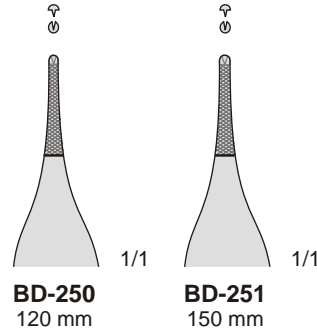

ADSON  
BD-300  
125 mm



BD-210/BD-215

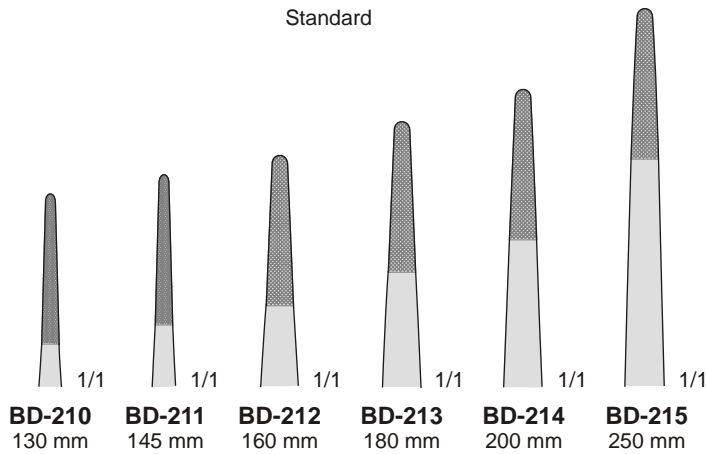

SEMKEN  
BD-216/BD-217

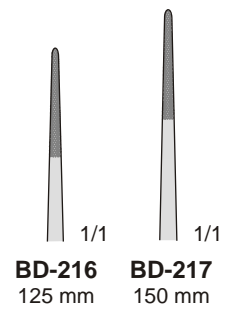

Chirurgische Pinzetten

Tissue forceps

Pinzette chirurgiche

Pinzas quirúrgicas

Pinces chirurgicales



**WANGENSTEEN**  
**BD-232/BD-234**

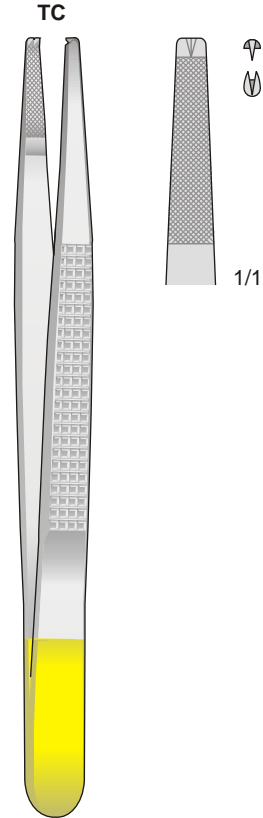
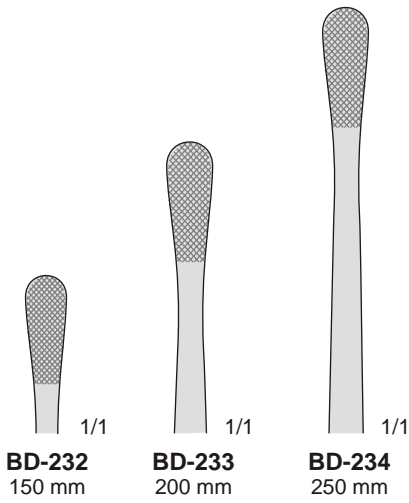

**BONNEY**  
**BD-252**  
180 mm



**CUSHING**  
**BD-226/BD-227**  
175 mm

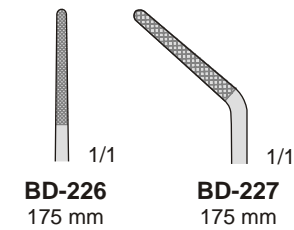

Mit Dissektor-Ende  
With Dissector End  
Con dissettore  
Con cabo disecador  
Avec bout disecteur



**POTTS-SMITH**  
**BD-218/BD-220**

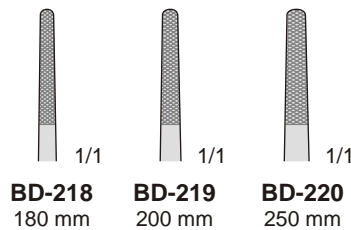

Mit Dissektor-Ende  
With Dissector End  
Con dissettore  
Con cabo disecador  
Avec bout disecteur



**TAYLOR**  
**BD-228**  
185 mm

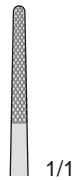







Mit Dissektor-Ende  
With Dissector End  
Con dissettore  
Con cabo disecador  
Avec bout disecteur

Mit Hartmetalleinsätzen - Tungsten-carbide forceps  
 Con punta al carburo di tungsteno - Pinzas con tungsteno  
 Avec plaquettes en carbure de tungstène

TC







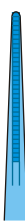

					
1/1	1/1	1/1	1/1	1/1	1/1
<b>BD-221</b> 145 mm	<b>BD-222</b> 160 mm	<b>BD-223</b> 180 mm	<b>BD-224</b> 200 mm	<b>BD-225</b> 250 mm	<b>BD-229</b> 300 mm

BD-221/BD-229

Titan - Titanium - Titanio - Titane

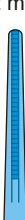
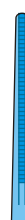

			
1,6 mm	1,6 mm	1,6 mm	1,6 mm
1/1	1/1	1/1	1/1
<b>BD-160T</b> 160 mm	<b>BD-161T</b> 180 mm	<b>BD-162T</b> 200 mm	<b>BD-163T</b> 240 mm
			
2 mm	2 mm	2 mm	2 mm
1/1	1/1	1/1	1/1
<b>BD-80T</b> 160 mm	<b>BD-81T</b> 180 mm	<b>BD-84T</b> 200 mm	<b>BD-86T</b> 240 mm

DE BAKEY  
 BD-80T/BD-163T

**Titan - Titanium - Titanio - Titane**

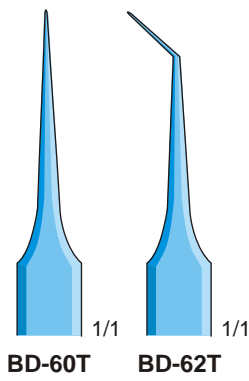
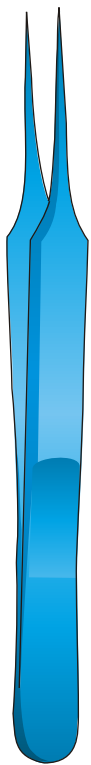

**BD-60T/BD-62T**  
110 mm

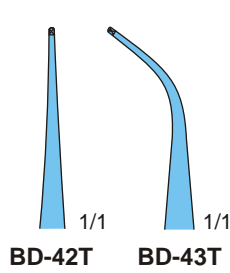

**BD-42T/BD-43T**  
110 mm

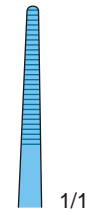

**BD-09T**  
130 mm

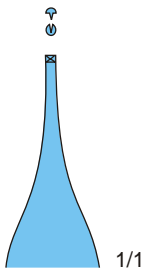

**ADSON  
BD-30T**  
120 mm

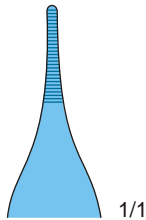
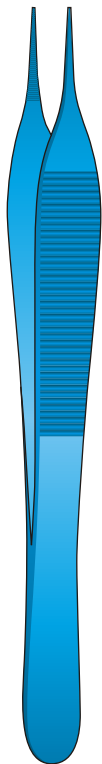

**ADSON  
BD-31T**  
120 mm

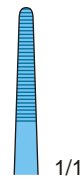

**BD-75T**  
145 mm

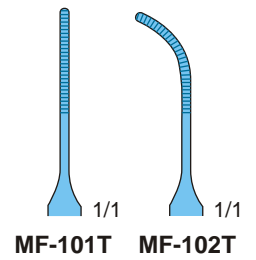

**GERALD  
MF-101T/MF-102T**  
180 mm

Ohr Pinzetten

Ear forceps

Pinzette auricolari

Pinzas auriculares

Pinces auriculaires

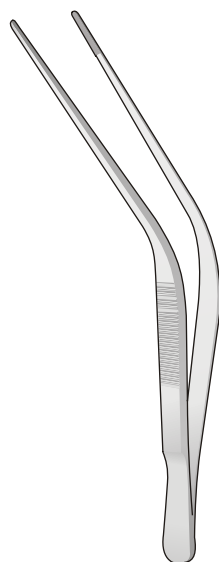

TROELTSCH  
**BD-22**  
110 mm

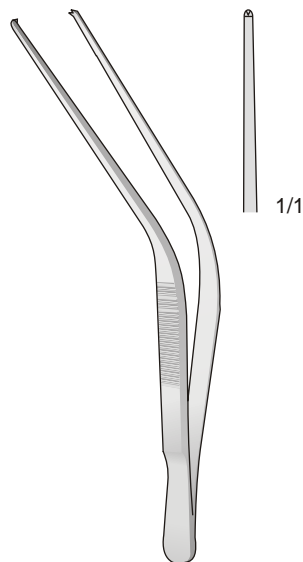

TROELTSCH  
**BD-146**  
110 mm

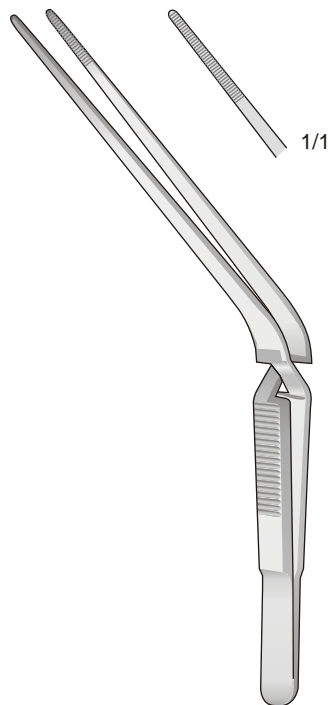

TROELTSCH  
**BD-179**  
130 mm

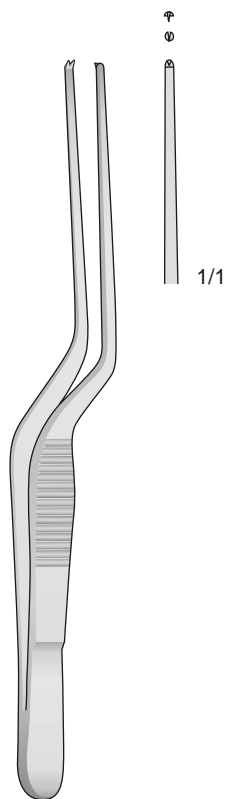

LUCAE  
**BD-147**  
140 mm

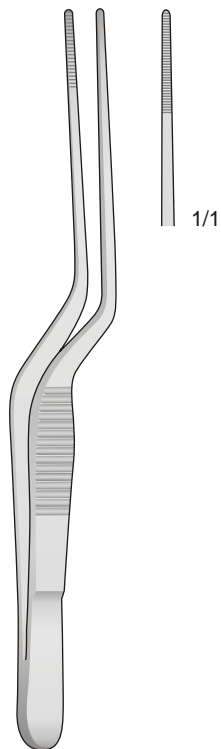

LUCAE  
**BD-101**  
140 mm

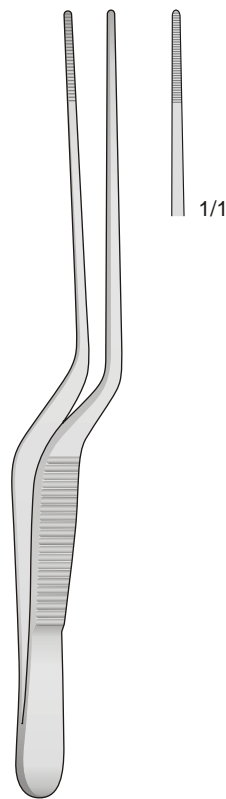

JANSEN  
**BD-102**  
160 mm

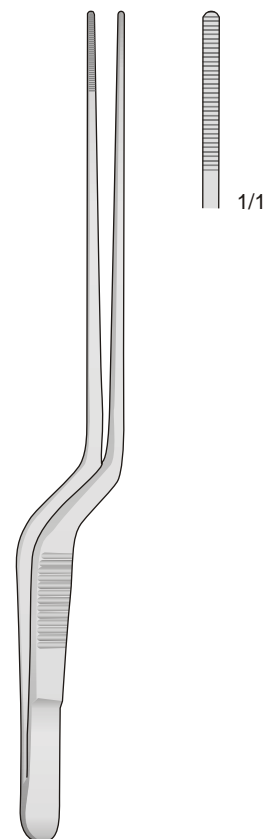

GRÜENWALD  
**BD-193**  
200 mm

Cilienpinzetten

Cilia forceps

Pinzette Depilatorie

Pinzas depilatorias

Pinces à épiler les cils

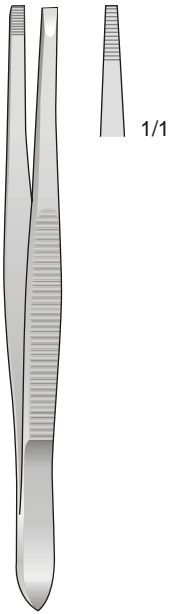

**ES-45**  
90 mm

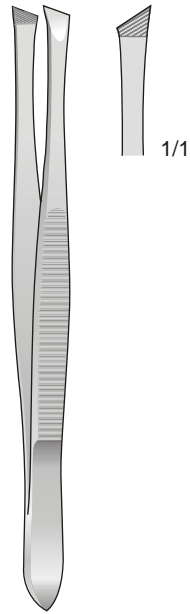

**ES-46**  
90 mm

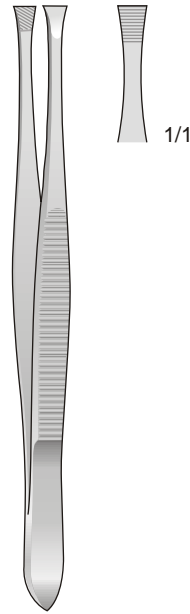

**LITTAUER**  
**ES-64**  
85 mm

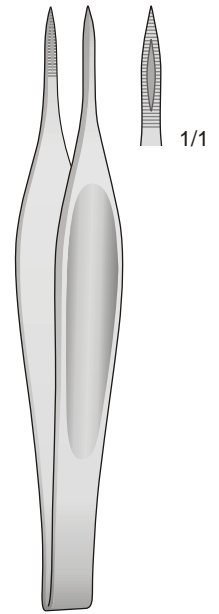

**FEICHENFELD**  
**BD-122**  
90 mm

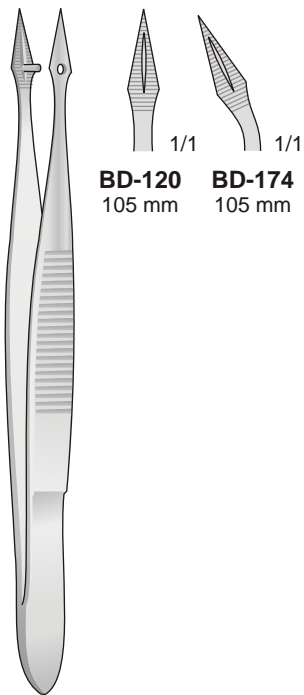
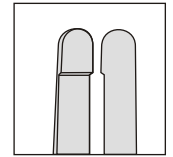
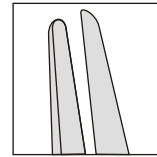
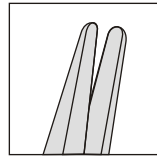

**HUNTER**  
**BD-120/BD-174**

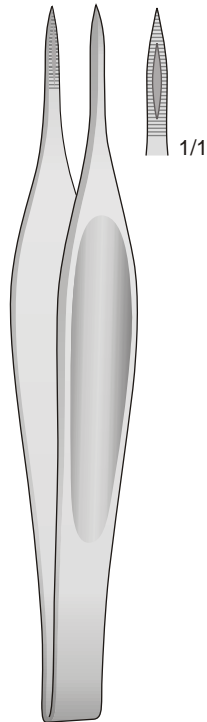

**FEICHENFELD**  
**BD-123**  
115 mm

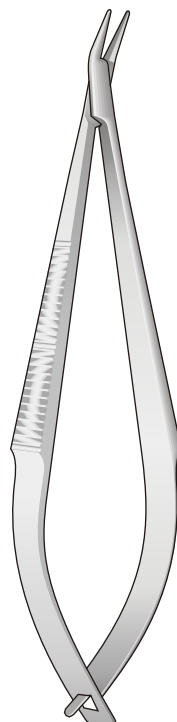

**BEAUPRE**  
**FD-117**  
110 mm

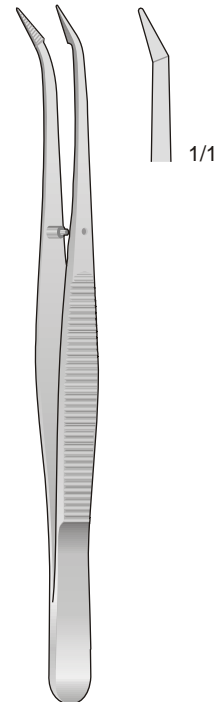

**BARRAQUER**  
**ES-65**  
105 mm

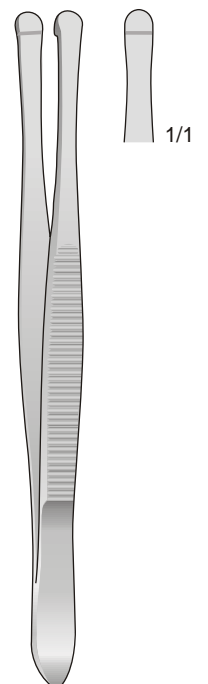

**BEER**  
**ES-48**  
90 mm



# SADIQ SURGICAL CO.

Catalogue 2015 / 2016



4

Arterienklemmen, Drahtumföhrungsnadel  
Hemostatic Forceps, Wire guides  
Pinze emostatische, Passafili  
Pinzas hemostáticas, Agujas para ligadura  
Pinces hémostatiques, Cerclage instruments





Demarcator

Face-Lift Klemmen  
 Face-Lift Forceps  
 Pinze per Face-Lift  
 Pinzas para Face-Lift  
 Pincés pour Face-Lift

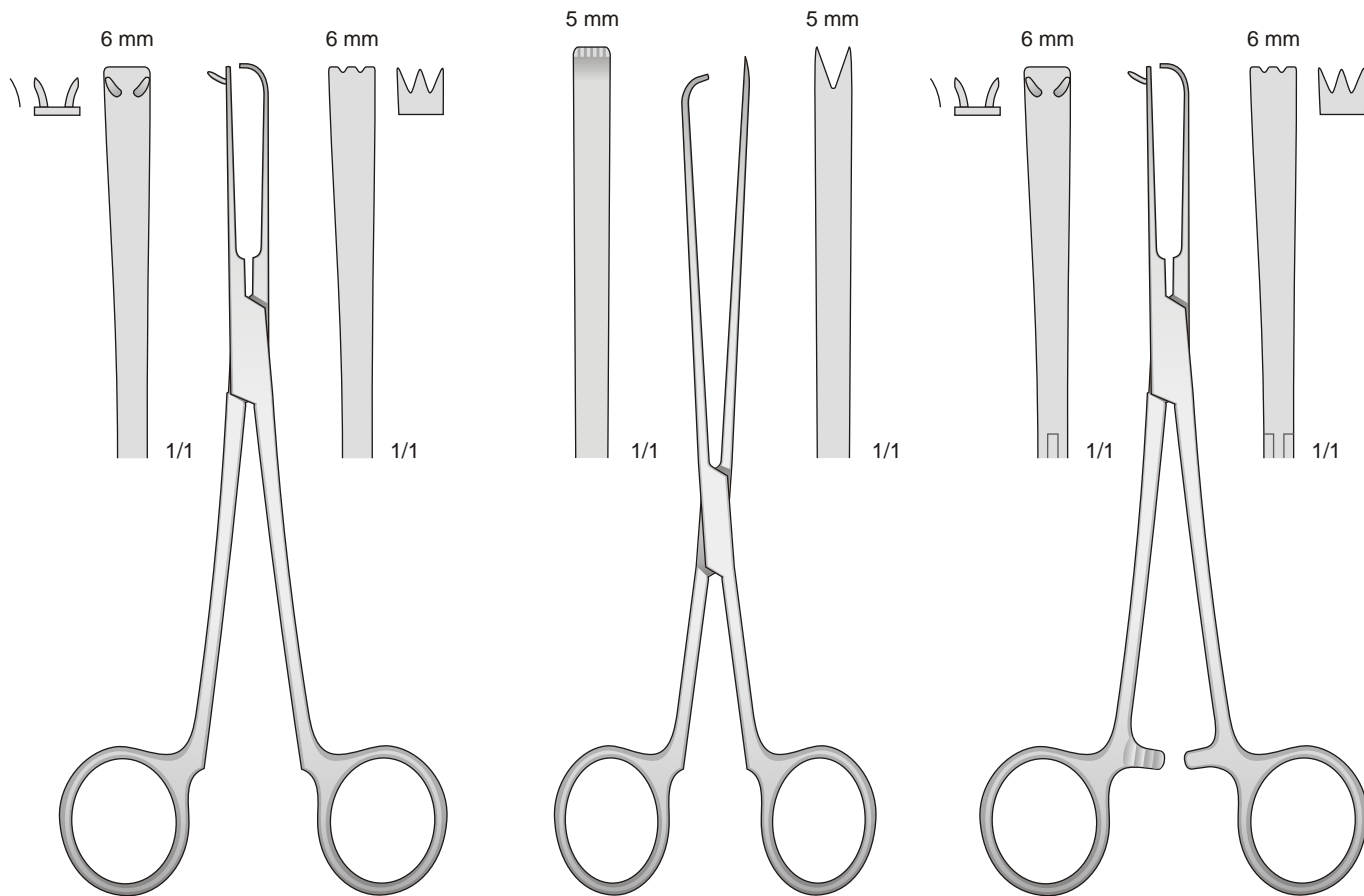

PITANGUI  
**ES-200**  
 165 mm

**ES-201**  
 165 mm

**ES-202**  
 165 mm

Gewebe und organ  
Fasszangen

Gum and tissue  
forceps

Pinze per afferrare  
i tessuti

Pinzas para coger las  
encias

Pinces pour saisir les  
tissue

4 x 5 Zähne  
4 x 5 Teeth  
4 x 5 Denti  
4 x 5 Dientes  
4 x 5 Dents

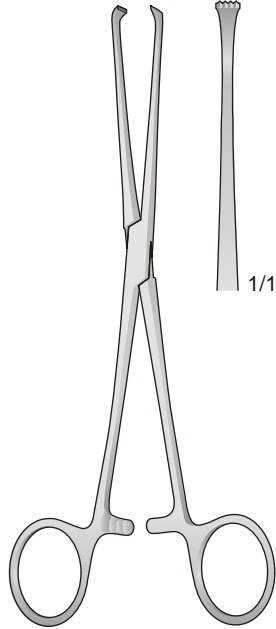

**BABY-ALLIS  
P-100**  
130 mm

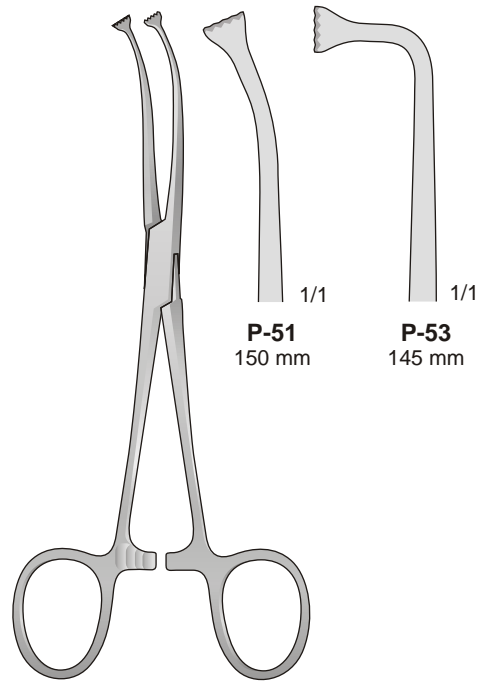

**ALLIS  
P-51/P-53**

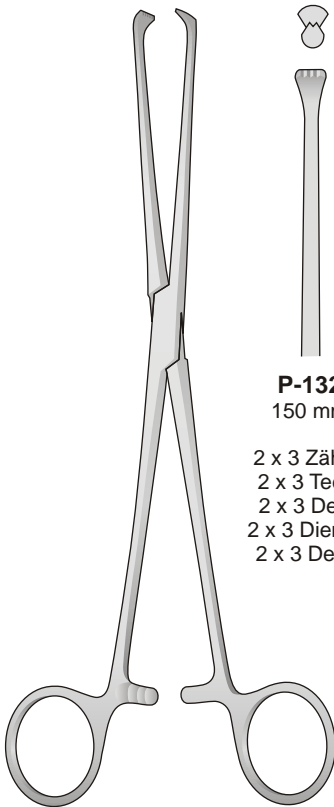

**ALLIS  
P-50/P-134**

1/1	1/1	1/1	1/1	1/1	1/1	1/1
<b>P-132</b> 150 mm	<b>P-133</b> 150 mm	<b>P-134</b> 150 mm	<b>P-50</b> 160 mm	<b>P-115</b> 200 mm	<b>P-119</b> 220 mm	<b>P-118</b> 250 mm
2 x 3 Zähne 2 x 3 Teeth 2 x 3 Denti 2 x 3 Dientes 2 x 3 Dents	3 x 4 Zähne 3 x 4 Teeth 3 x 4 Denti 3 x 4 Dientes 3 x 4 Dents	4 x 5 Zähne 4 x 5 Teeth 4 x 5 Denti 4 x 5 Dientes 4 x 5 Dents	5 x 6 Zähne 5 x 6 Teeth 5 x 6 Denti 5 x 6 Dientes 5 x 6 Dents	5 x 6 Zähne 5 x 6 Teeth 5 x 6 Denti 5 x 6 Dientes 5 x 6 Dents	5 x 6 Zähne 5 x 6 Teeth 5 x 6 Denti 5 x 6 Dientes 5 x 6 Dents	5 x 6 Zähne 5 x 6 Teeth 5 x 6 Denti 5 x 6 Dientes 5 x 6 Dents

Fine-Arterienklemmen

Fine  
Artery forceps

Pinze emostatiche  
delicate

Pinzas hemostáticas  
fino

Delicate  
Pincers hémostàtiques

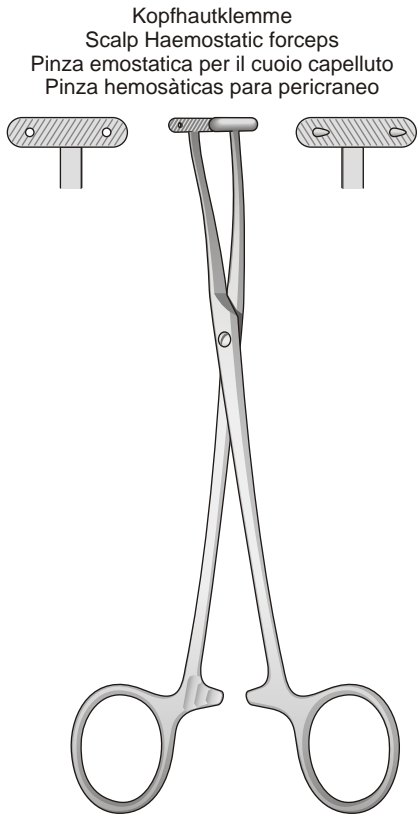

**DE MARTEL**  
**FB-120**  
180 mm

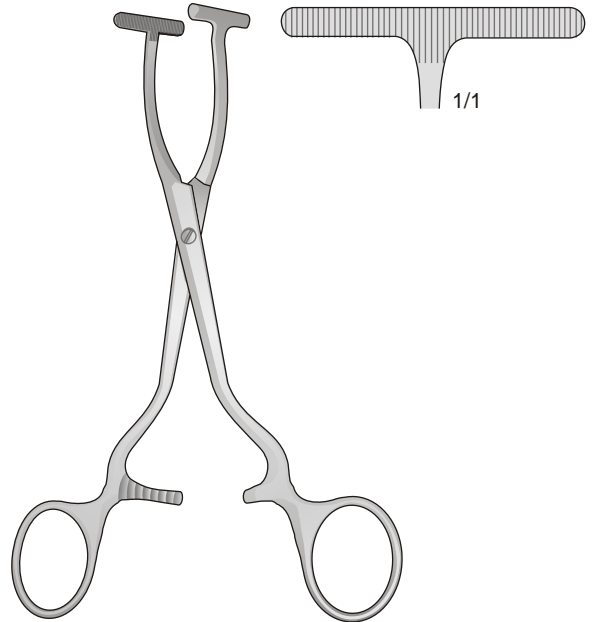

**P-207**  
150 mm

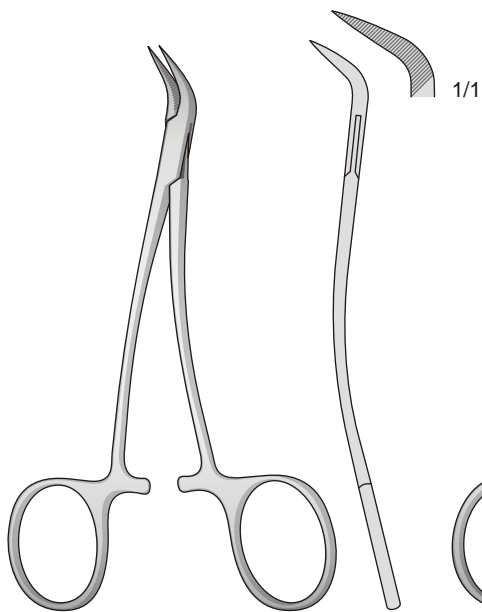

**PEET**  
**DR-40**  
120 mm

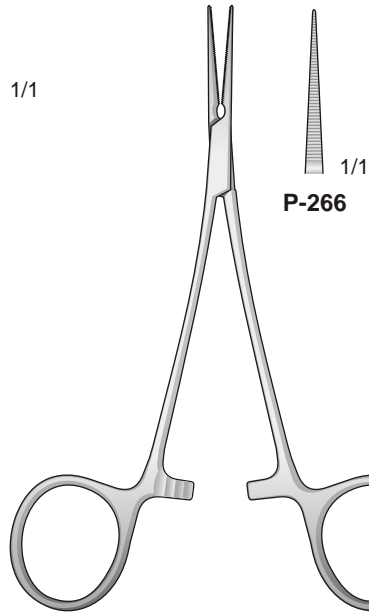

**JACOBSON-MICRO**  
**P-266**  
130 mm

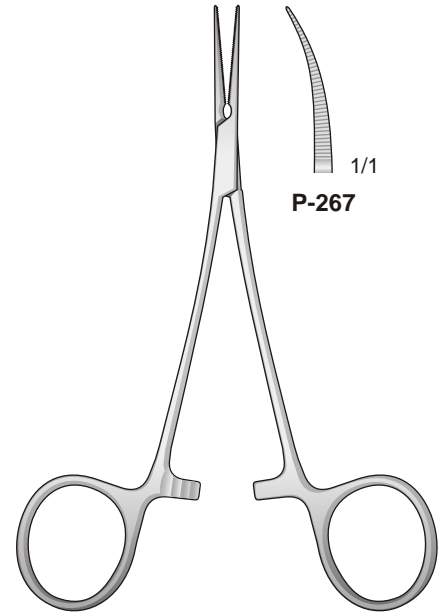

**JACOBSON-MICRO**  
**P-267**  
130 mm

Tuchklemmen

Towel clamps

Fissateli

Pinzas de campo

Pinces pour fixer les compresses

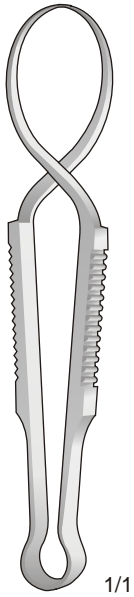

1/1

**SCHAEDEL**  
**BF-38**  
85 mm

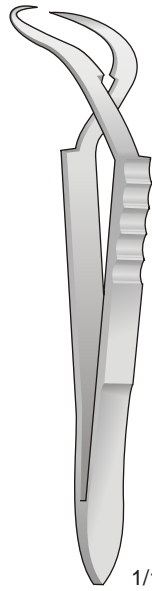

1/1

**JONES**  
**BF-48**  
90 mm

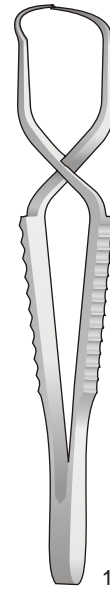

1/1

**FAURE**  
**BF-40**  
85 mm

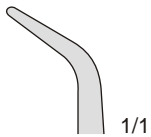

1/1

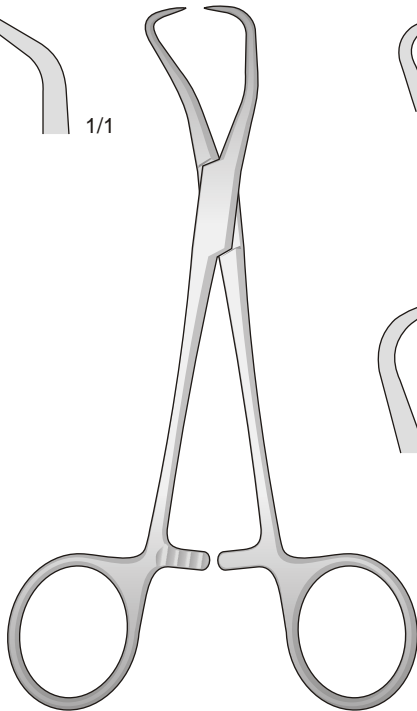

**BACKHAUS**  
**BF-41/BF-46**

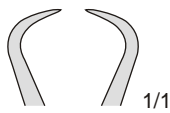

1/1

**BF-42**  
90 mm

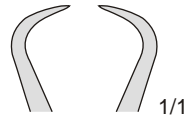

1/1

**BF-41**  
100 mm

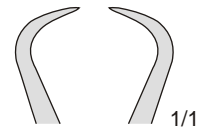

1/1

**BF-44**  
110 mm

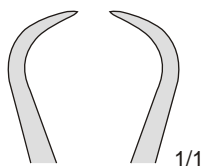

1/1

**BF-46**  
130 mm

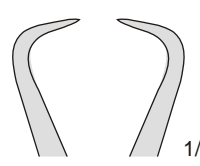

1/1

**BF-43**  
135 mm

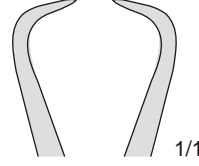

1/1

**BF-45**  
140 mm

Tuchklemmen

Towel clamps

Fissateli

Pinzas de campo

Pinces pour fixer les compresses

Für Papiertücher  
For paper cloths  
Per teli di carta  
Para paños  
Pour Champs en papier

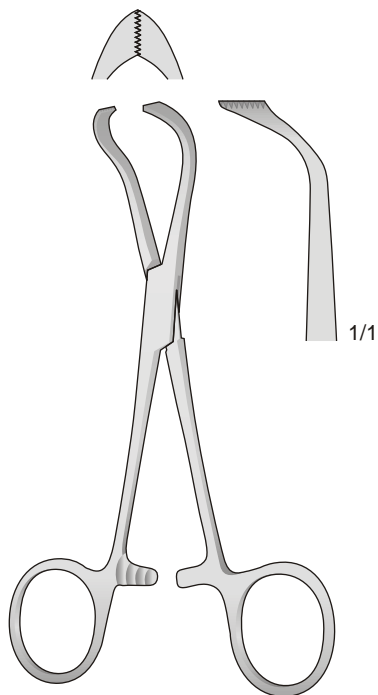

LORNA  
**BF-50**  
100 mm

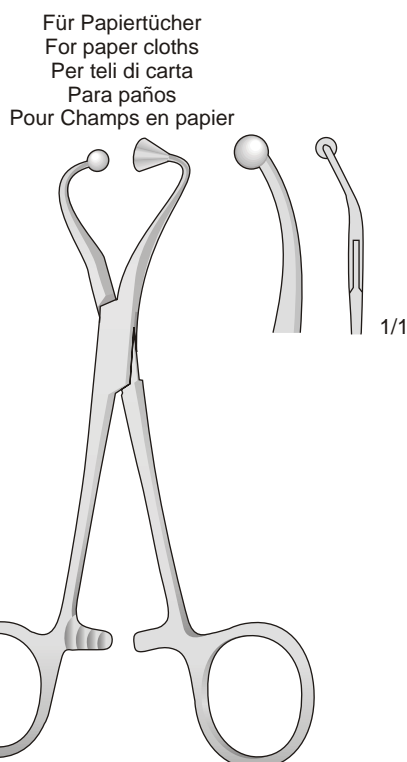

**BF-74**  
115 mm

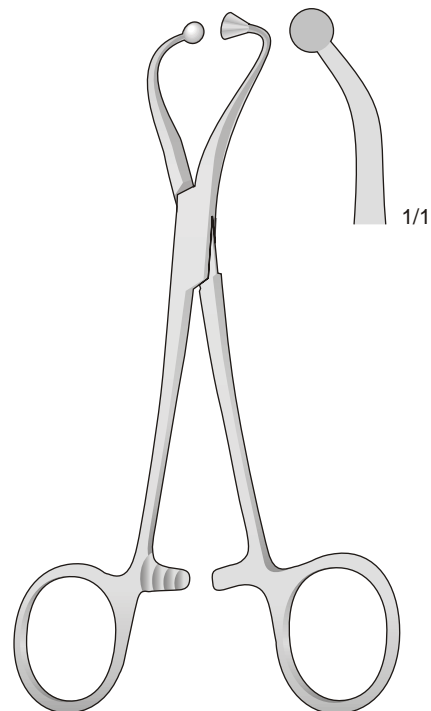

**BF-75**  
140 mm

Für Papiertücher - For paper cloths  
Per teli di carta - Para paños  
Pour Champs en papier

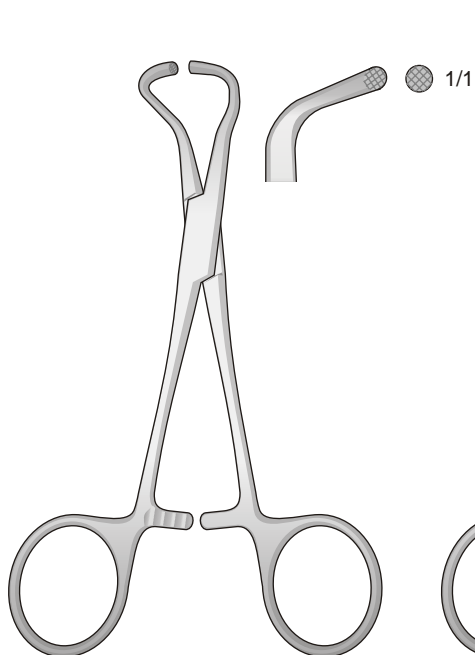

**BF-76**  
100 mm

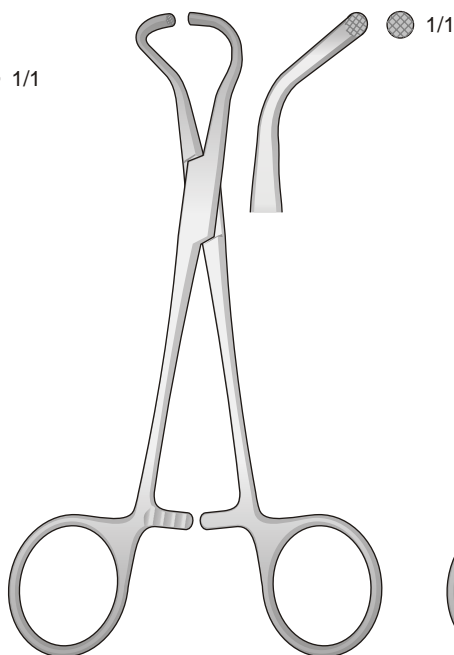

**BF-77**  
125 mm

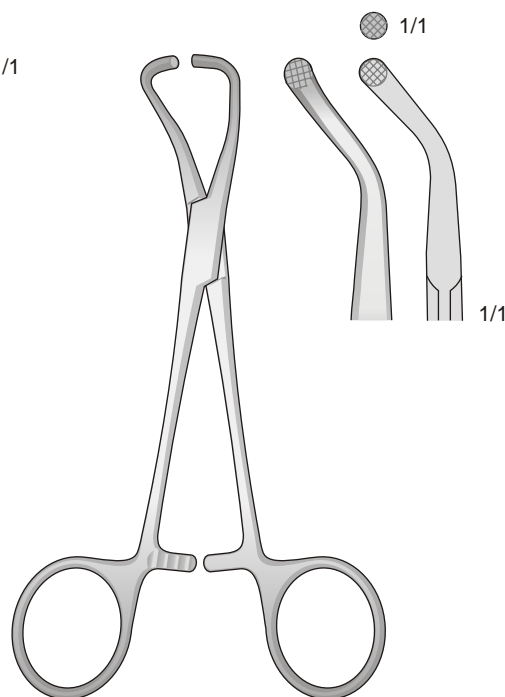

**BF-52**  
130 mm

Arterienklemmen

Hemostatic forceps

Pinze emostatiche

Pinces hémostatiques

Pinces hémostatiques

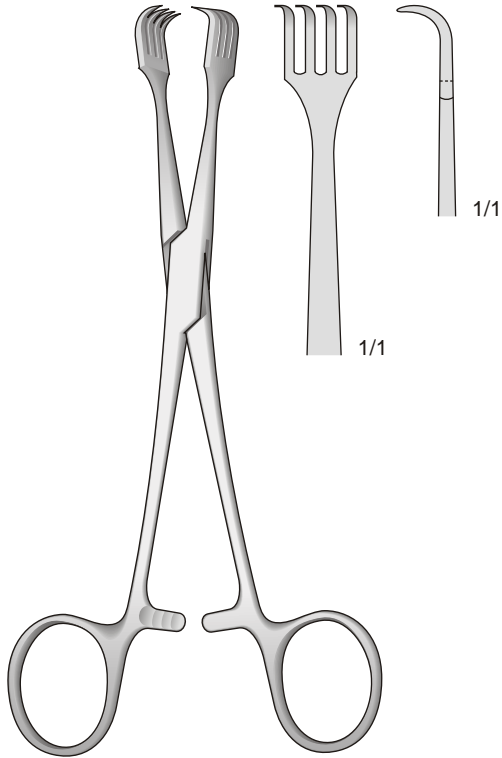

**BRAUN  
BF-58  
155 mm**

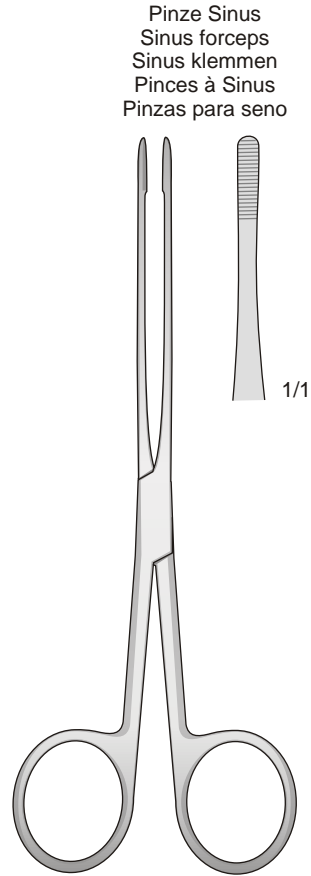

**LISTER  
BF-20  
150 mm**

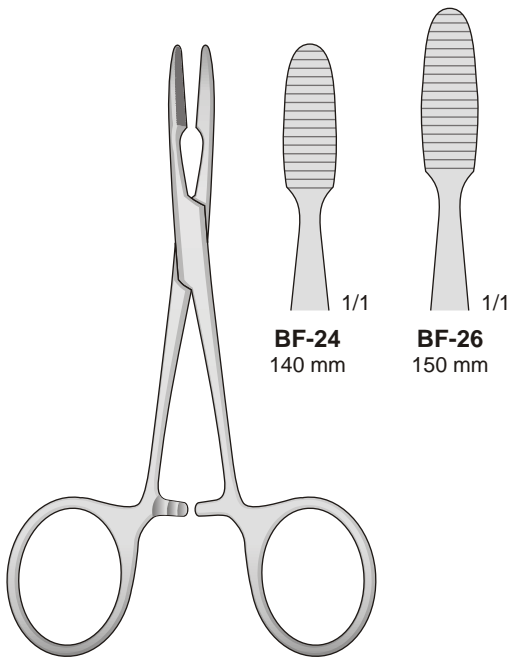

**PEAN-MURPHY  
BF-24/BF-26**

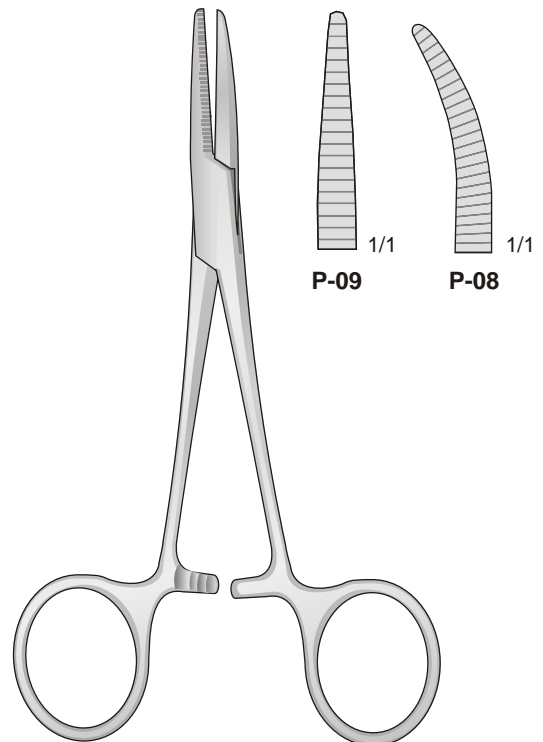

**JONES  
P-09/P-08  
150 mm**

Schwamm und  
Tamponzangen

Sponge and dressing  
forceps

Pinze per tamponi

Pinces à tampons

Pinces à tampons

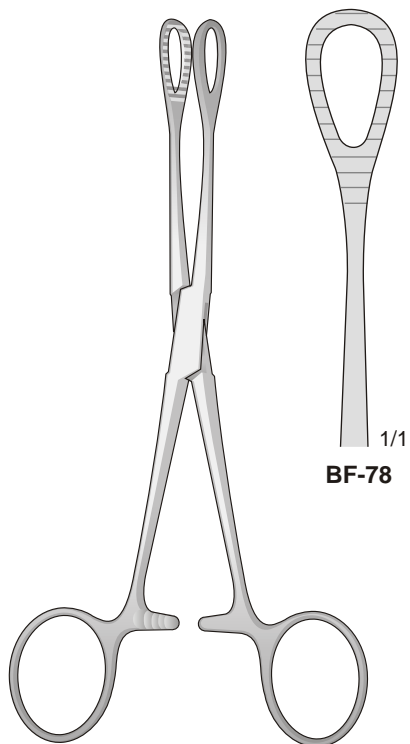

FOERSTER-BALLENGER  
**BF-78/BF-79**  
180 mm

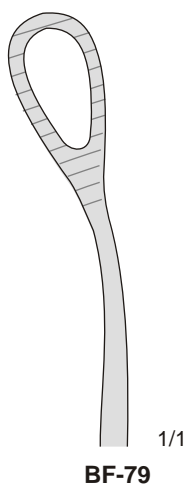

**BF-79**

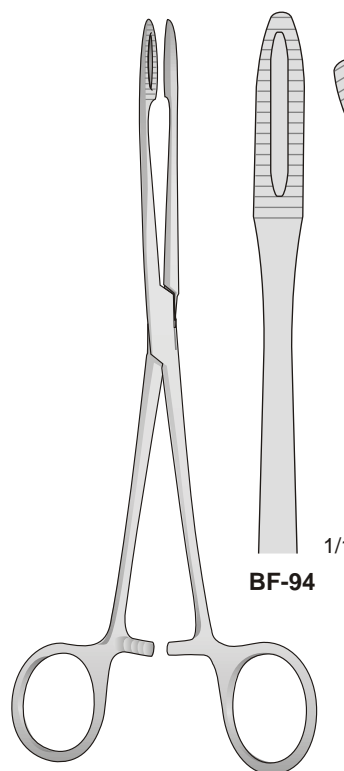

GROSS  
**BF-94/BF-95**  
200 mm

**BF-94**

**BF-95**

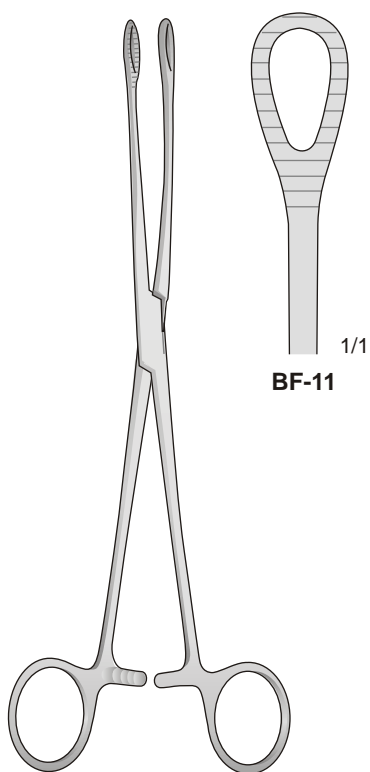

FOERSTER-BALLENGER  
**BF-11/BF-13**  
240 mm

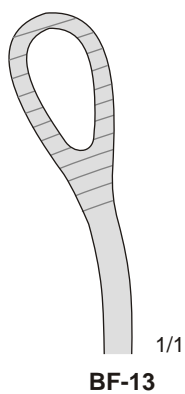

**BF-13**

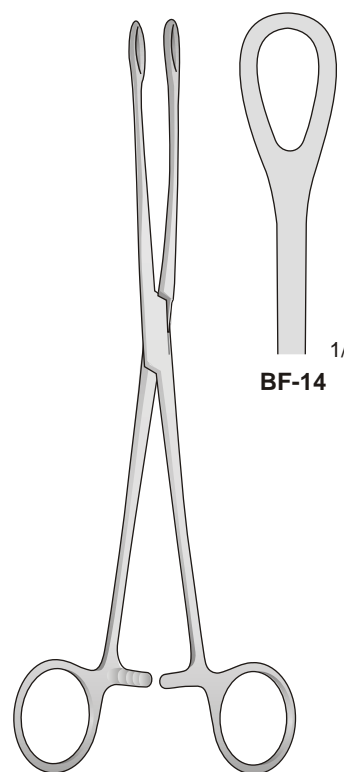

FOERSTER-BALLENGER  
**BF-14/BF-15**  
240 mm

**BF-14**

**BF-15**

Schwamm und  
Tamponzangen

Sponge and dressing  
forceps

Pinze per tamponi

Pinces à tampons

Pinces à tampons

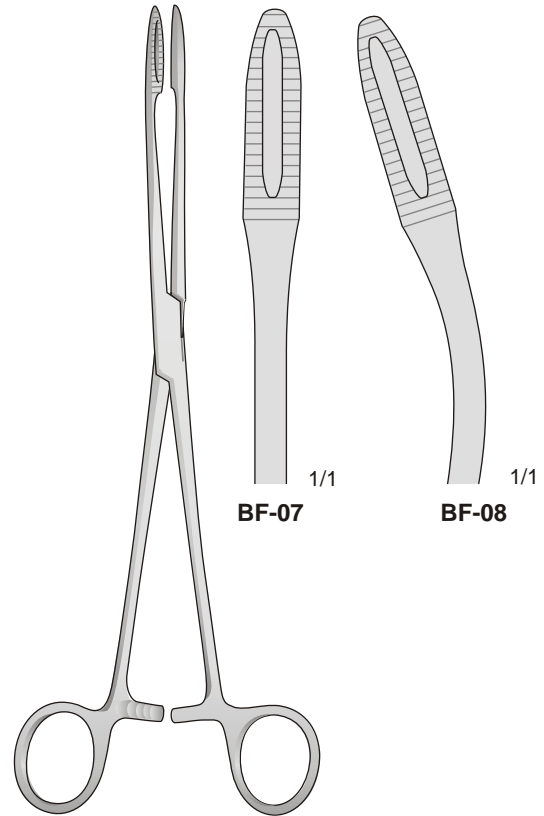
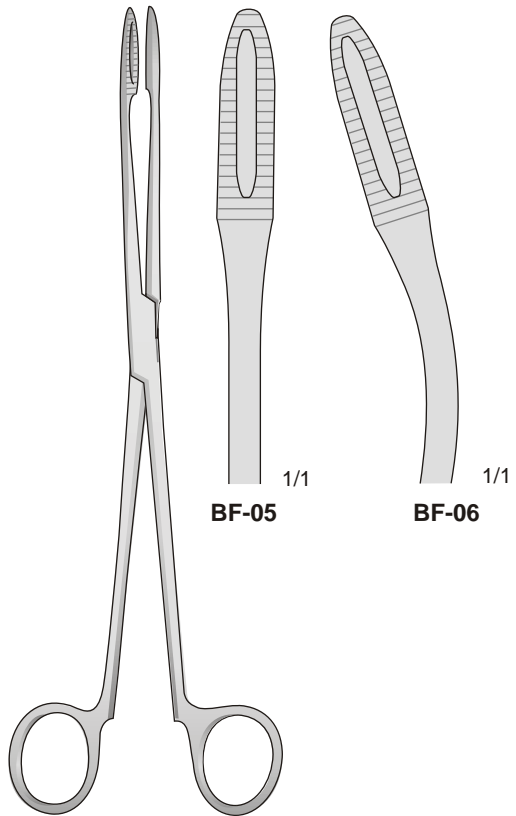
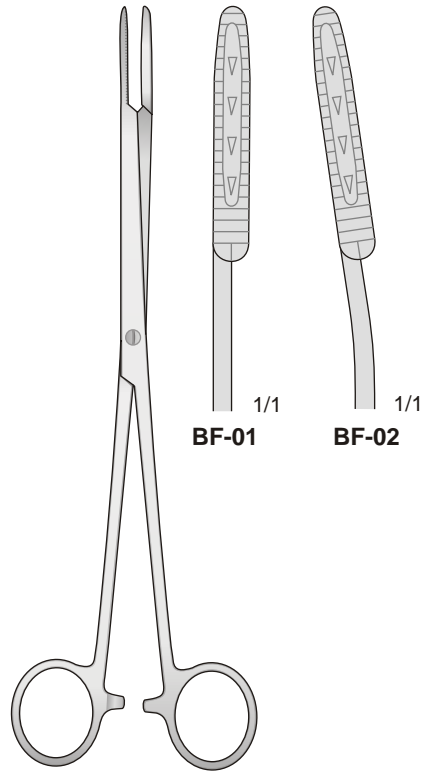
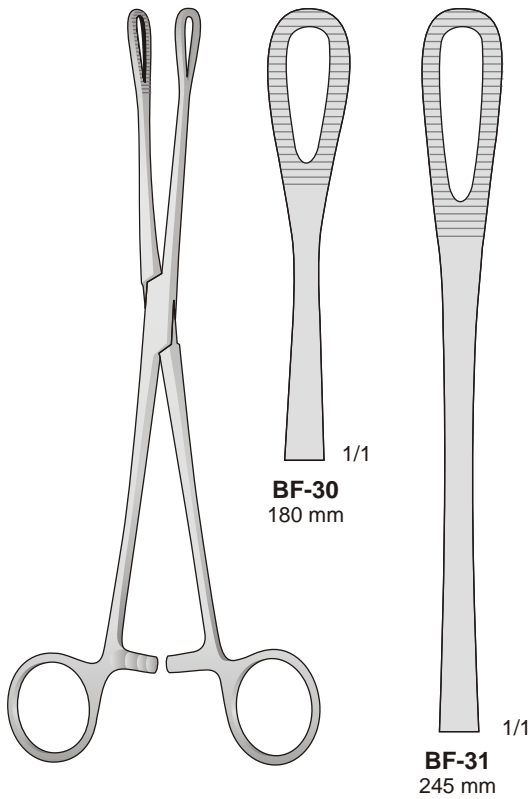

**MAIER  
BF-05/BF-06  
265 mm**

**MAIER  
BF-07/BF-08  
265 mm**



Fine-Arterienklemmen

Fine  
Artery forceps

Pinze emostatiche  
delicate

Pinzas hemostáticas  
fino

Delicate  
Pincés hémostáticas

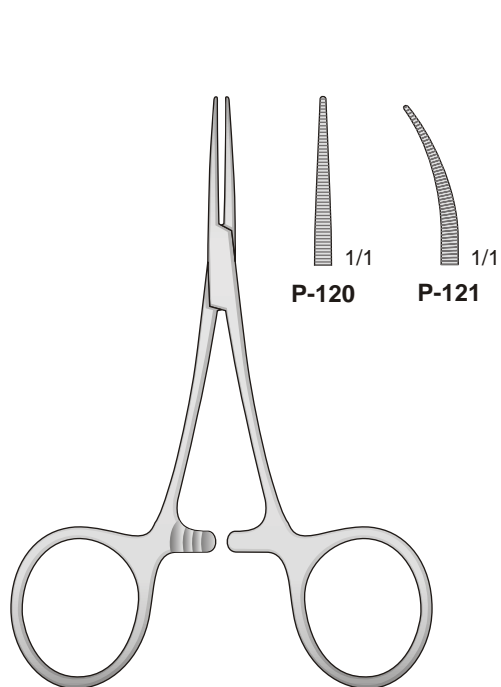

HARTMANN-BABY-MOSQUITO  
**P-120/P-121**  
95 mm

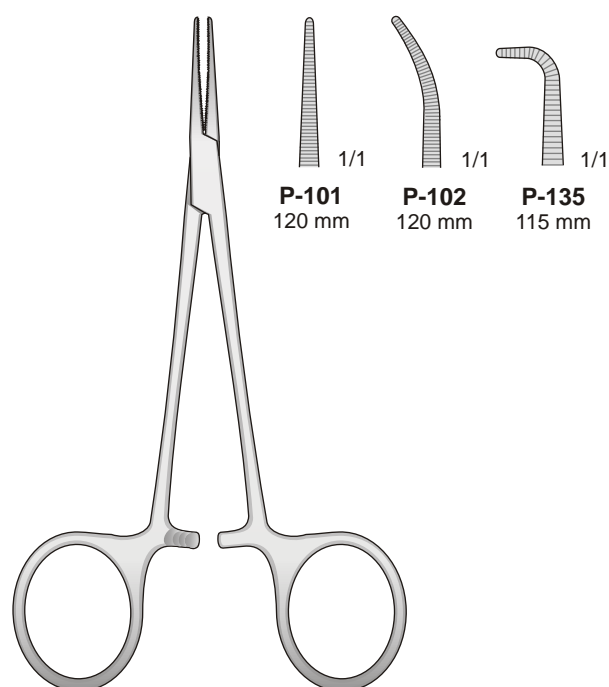

MICRO-HALSTED  
**P-101/P-135**

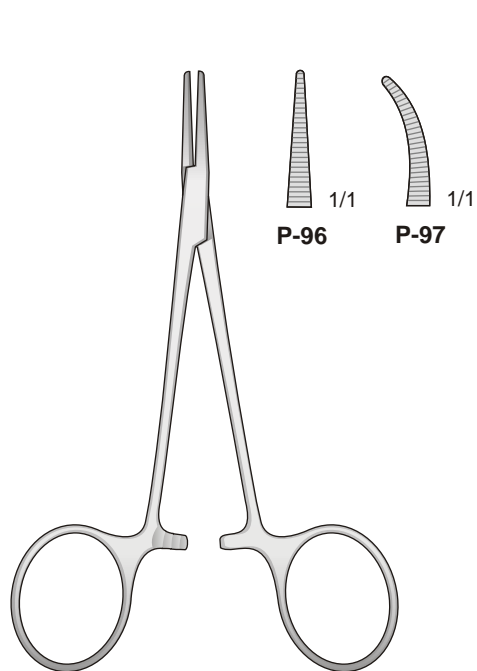

HALSTED-MOSQUITO  
**P-96/P-97**  
120 mm

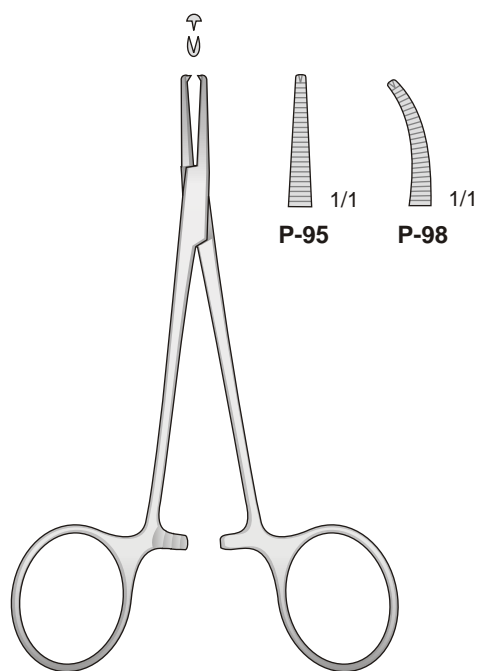

HALSTED-MOSQUITO  
**P-95/P-98**  
120 mm

Fine-Arterienklemmen

Fine  
Artery forceps

Pinze emostatiche  
delicate

Pinzas hemostáticas  
fino

Delicate  
Pincés hémostáticas

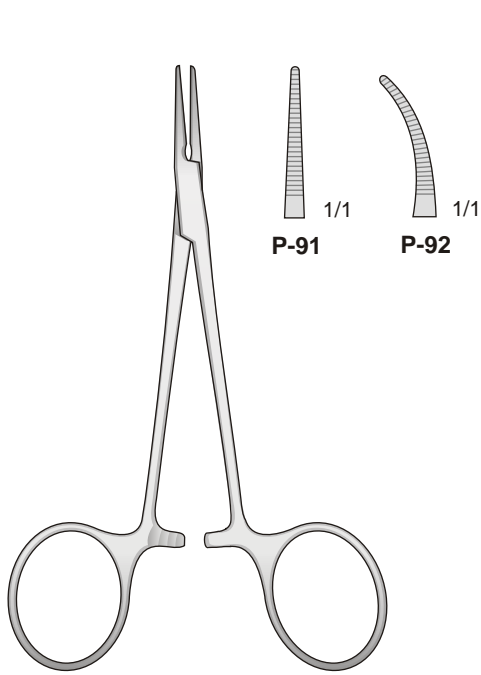

HALSTED  
**P-91/P-92**  
125 mm

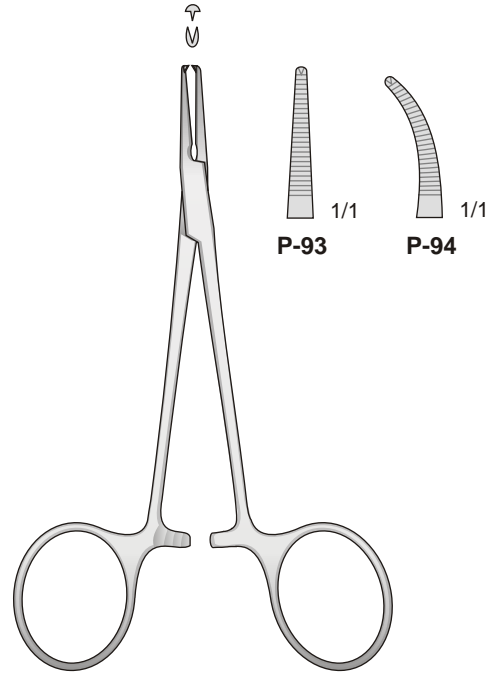

HALSTED  
**P-93/P-94**  
125 mm

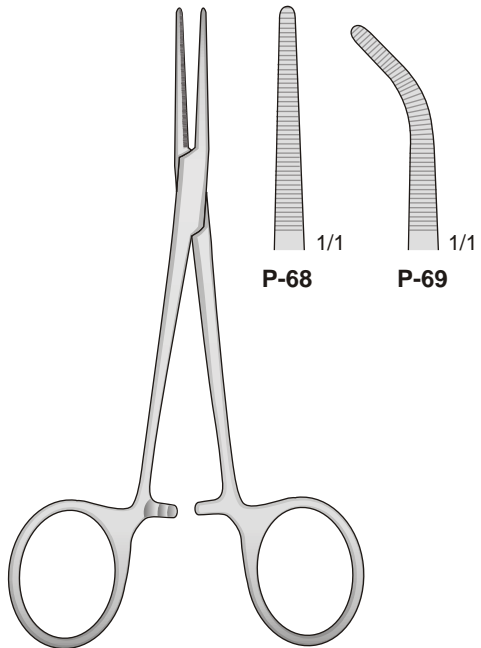

GIDEF  
**P-68/P-69**  
140 mm

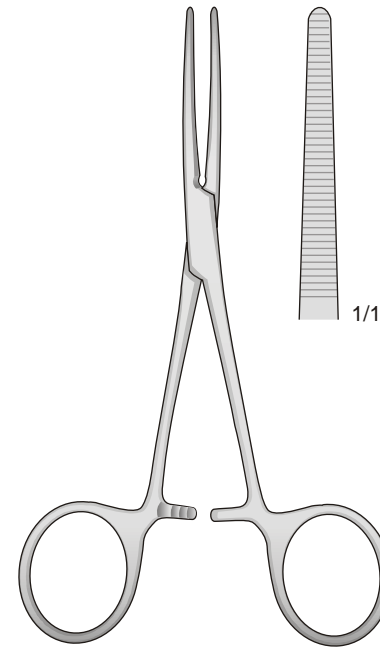

PEAN  
**P-17**  
140 mm

Arterienklemmen

Hemostatic forceps

Pinze emostatiche

Pinzas hemostáticas

Pinces hémostatiques

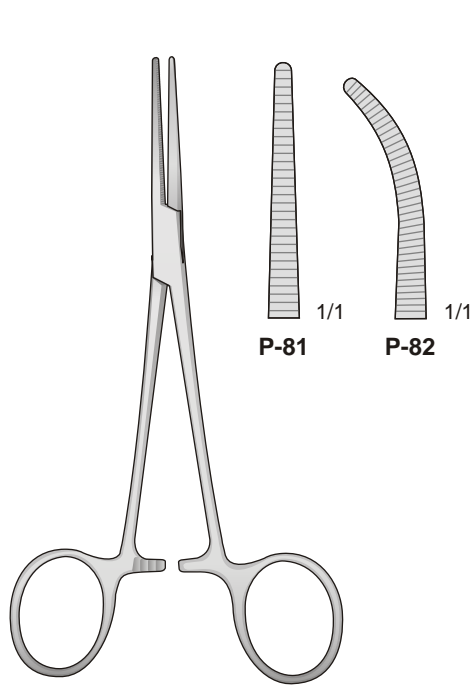

CRILE  
P-81/P-82  
140 mm

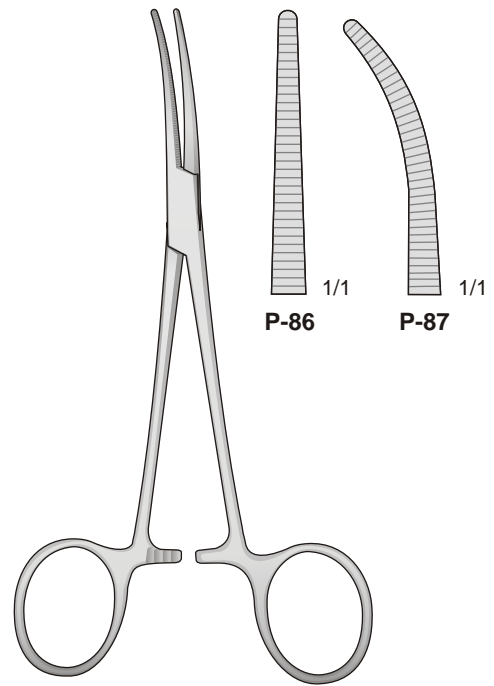

CRILE  
P-86/P-87  
160 mm

Seitwärts gebogen  
Curved to side  
Curve sul lato  
Curvas laterales  
Courbes latérales

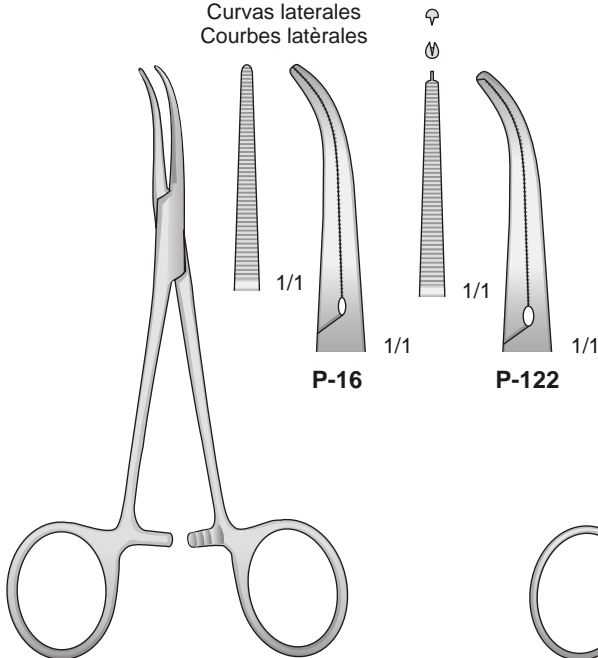

DANDY  
P-16/P-122  
140 mm

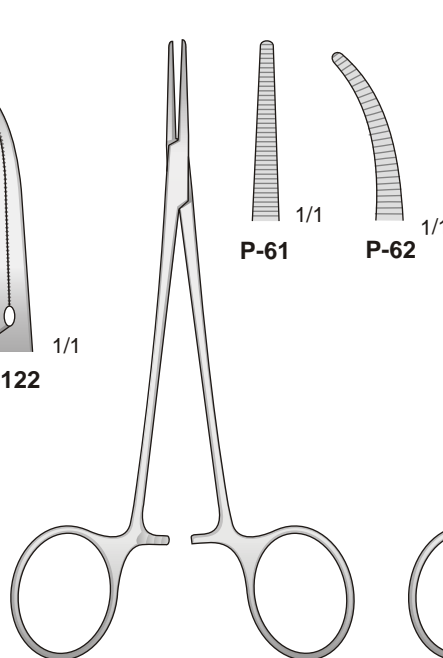

LERICHE  
P-61/P-62  
150 mm

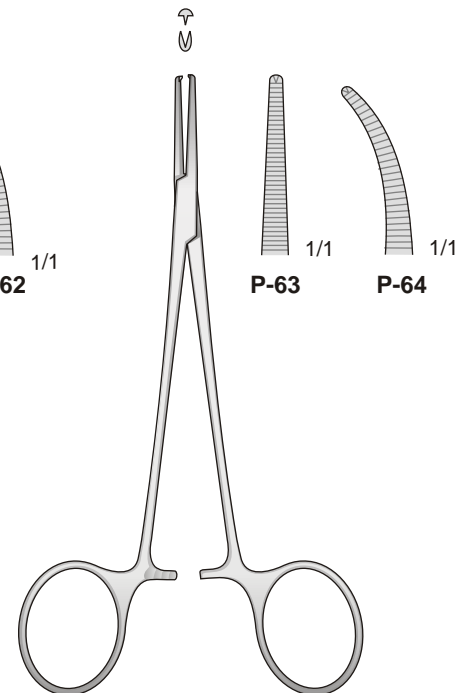

LERICHE  
P-63/P-64  
150 mm

Arterienklemmen

Hemostatic forceps

Pinze emostatiche

Pinzas hemostáticas

Pinces hémostatiques

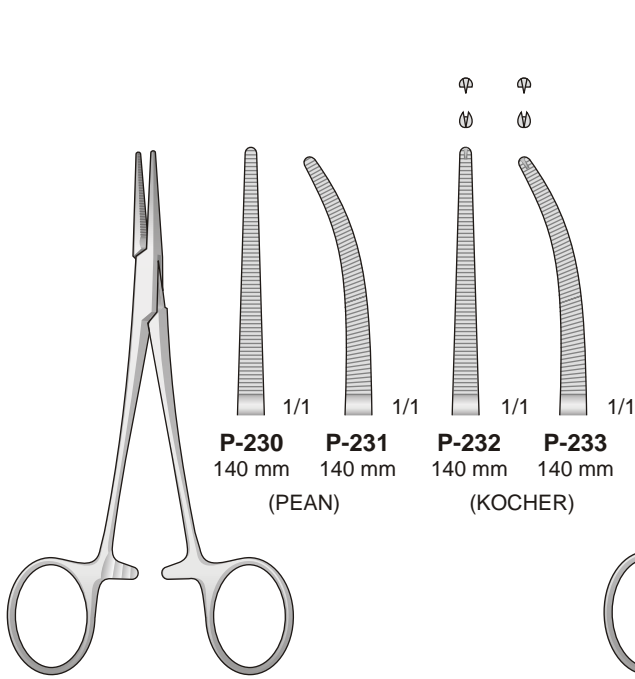

**BABY-CRILE**  
**P-230/P-233**  
140 mm

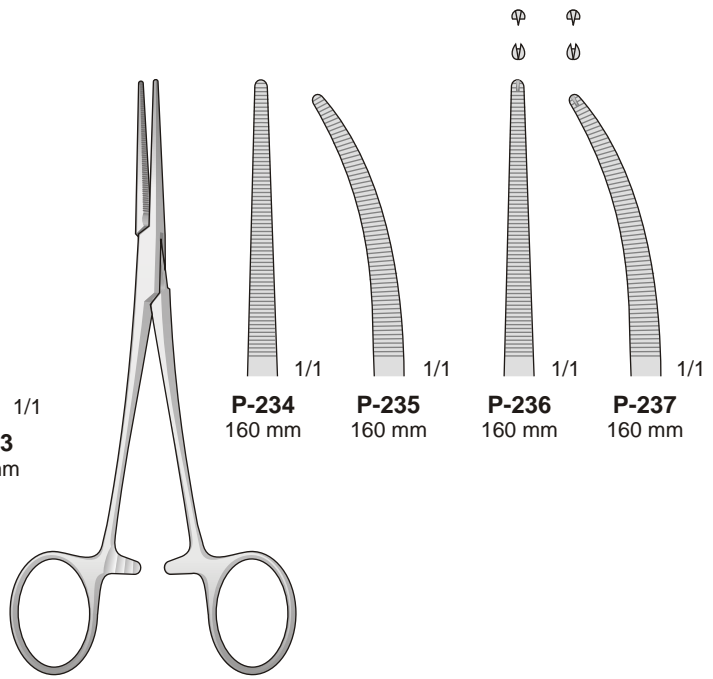

**CRILE**  
**P-234/P-237**  
160 mm

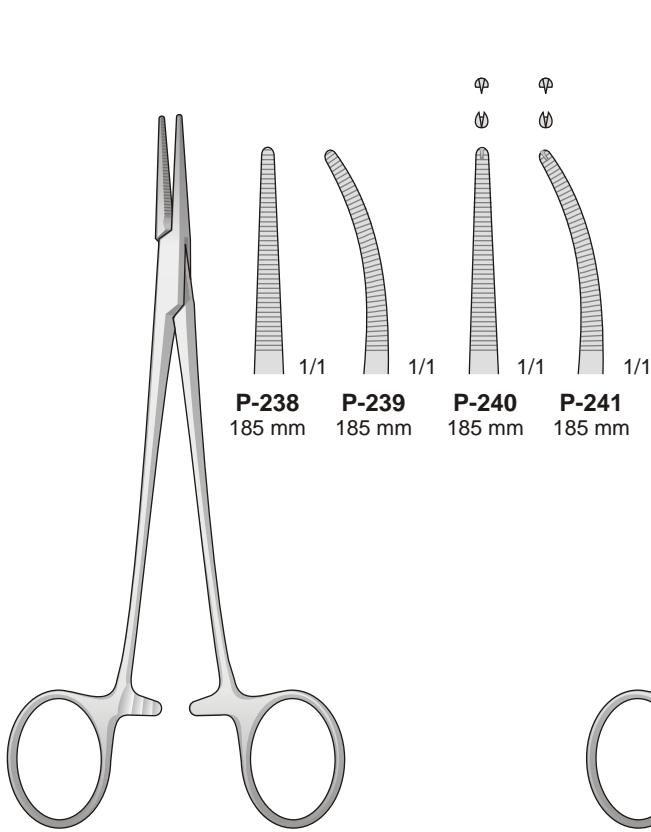

**HALSTED**  
**P-238/P-241**  
185 mm

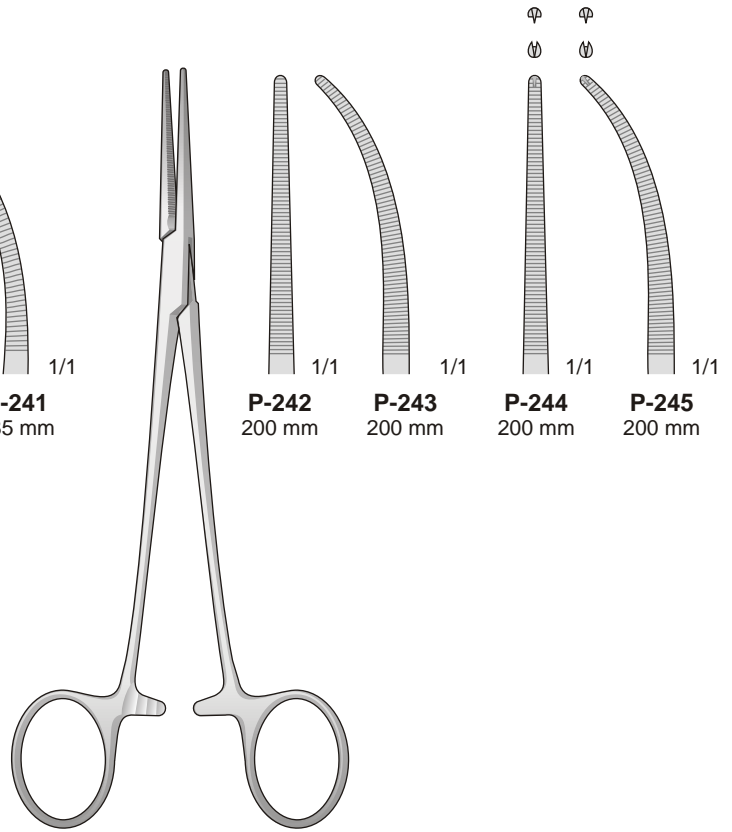

**HALSTED-MOSQUITO**  
**P-242/P-245**  
200 mm

Arterienklemmen

Hemostatic forceps

Pinze emostatiche

Pinzas hemostáticas

Pinces hémostatiques

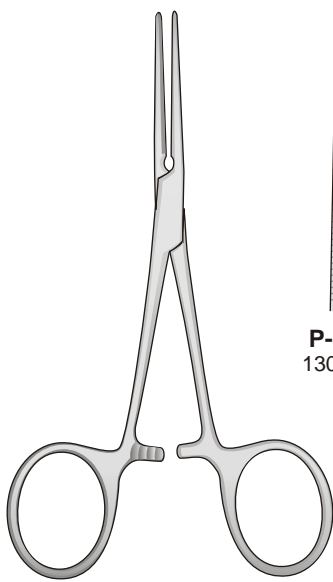

PEAN  
P-250/P-255

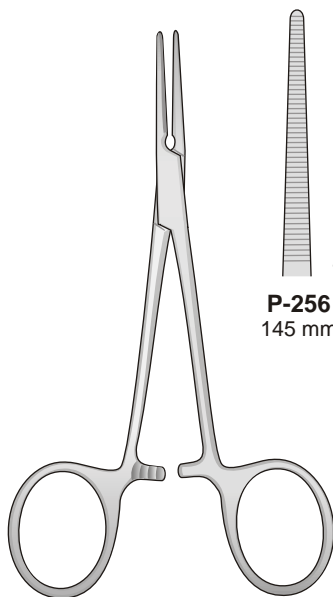
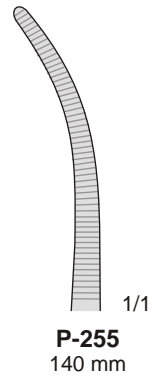
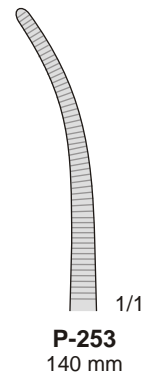
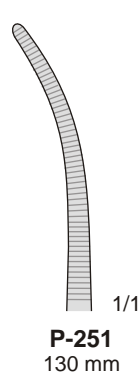
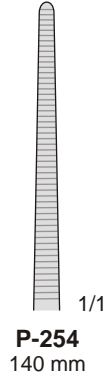
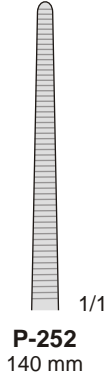
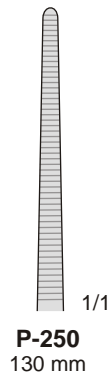

PEAN  
P-256/P-259

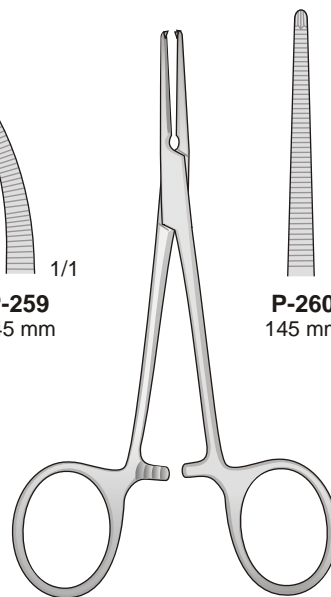
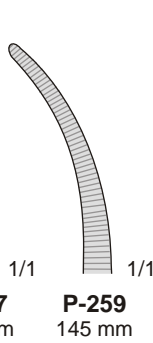
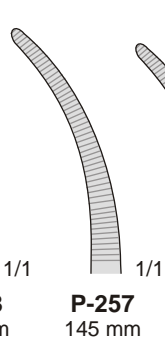
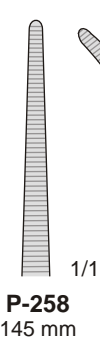
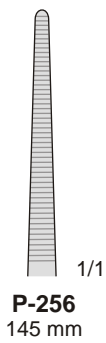

KOCHER  
P-260/P-263

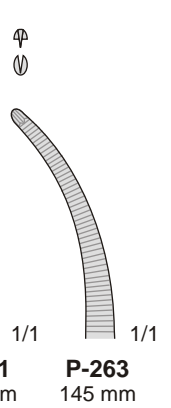
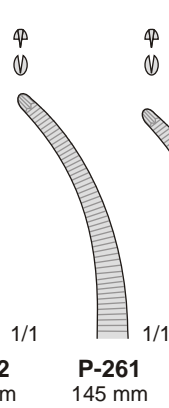
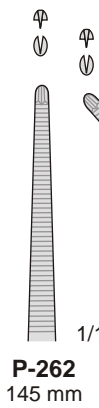
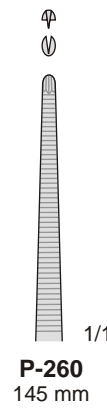

Arterienklemmen

Hemostatic forceps

Pinze emostatiche

Pinzas hemostáticas

Pinces hémostatiques

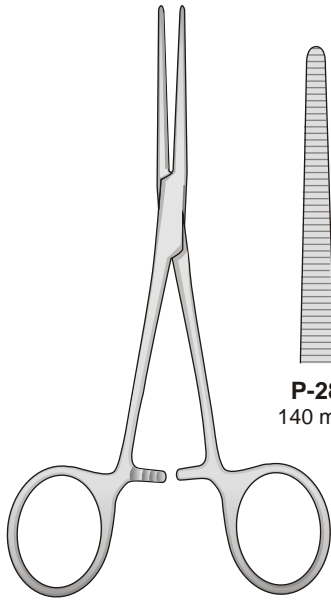

**ROCHESTER-PEAN  
P-18/P-29**

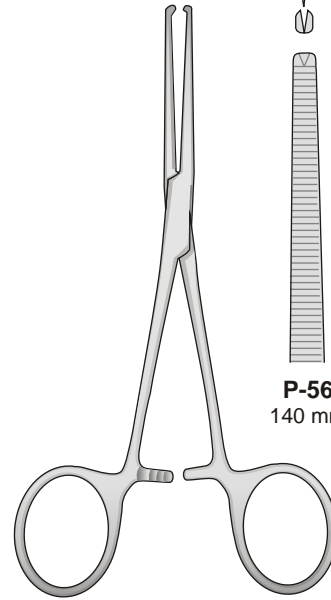
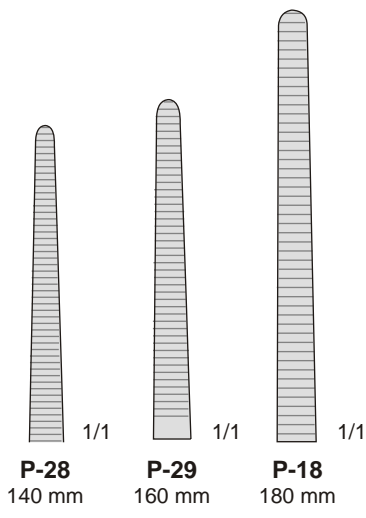

**KOCHER-OCHSNER  
P-56/P-221**

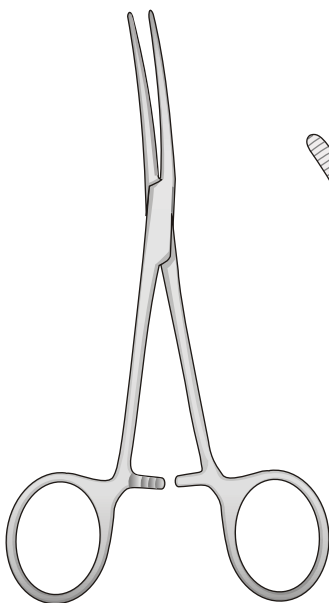
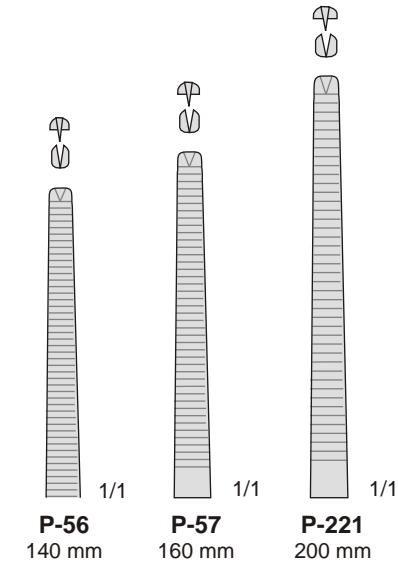

**ROCHESTER-PEAN  
P-19/P-39**

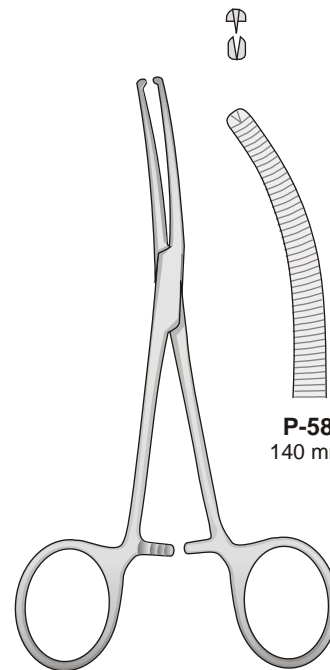
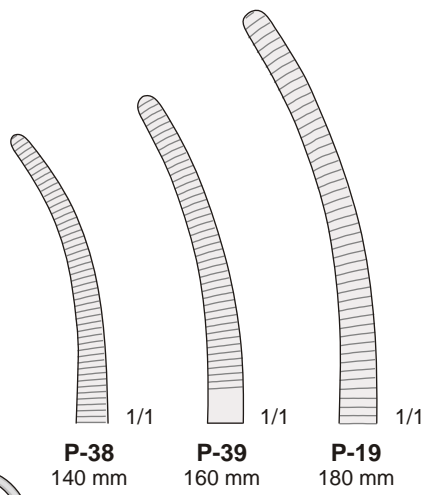

**KOCHER-OCHSNER  
P-58/P-59**

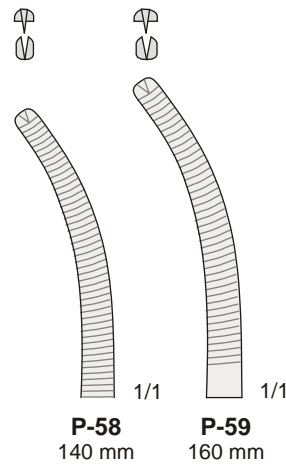

Arterienklemmen

Hemostatic forceps

Pinze emostatiche

Pinzas hemostáticas

Pinces hémostatiques

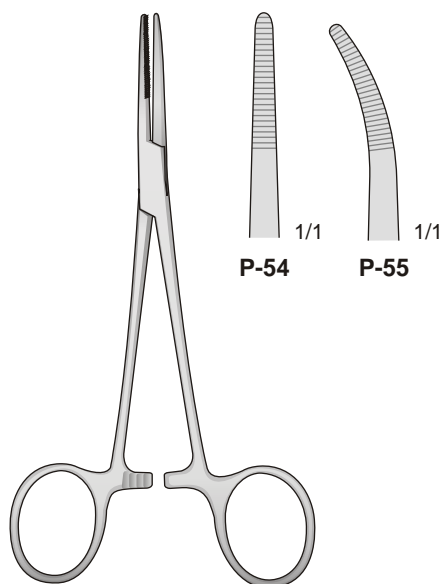

KELLY  
P-54/P-55  
140 mm

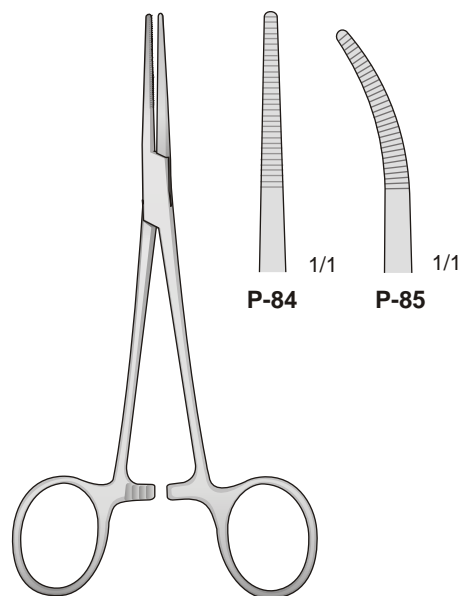

KELLY  
P-84/P-85  
140 mm

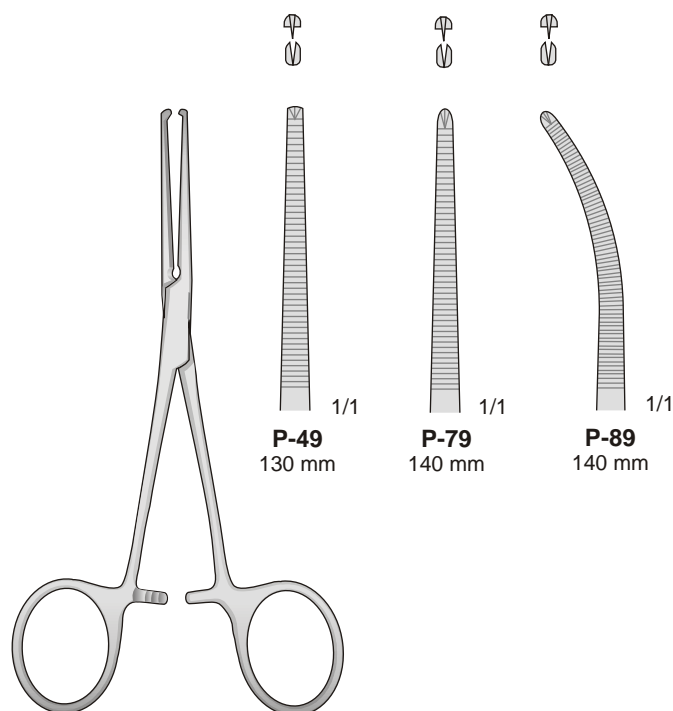

KOCHER  
P-49/P-89

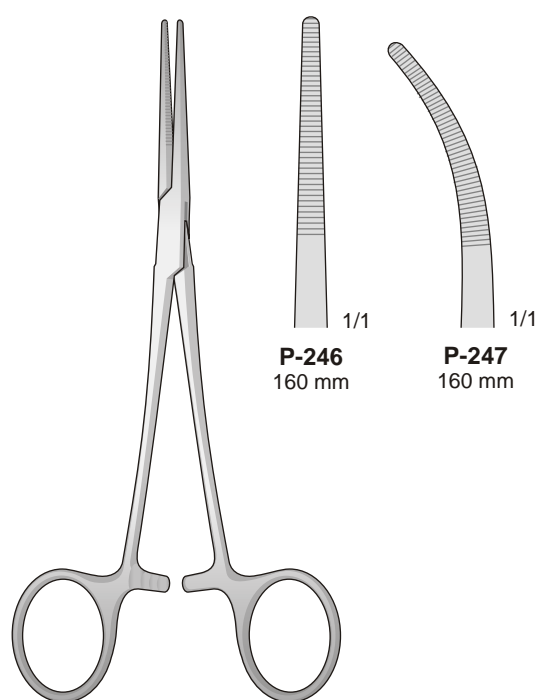

RANKIN  
P-246/P-247

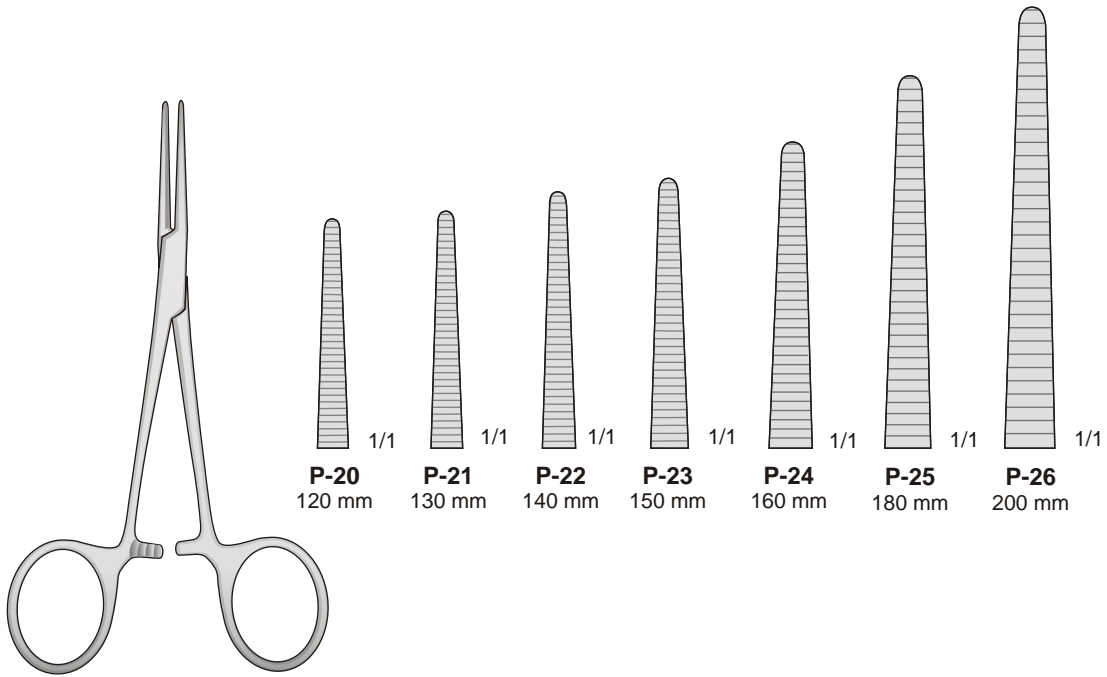

PEAN  
P-20/P-26

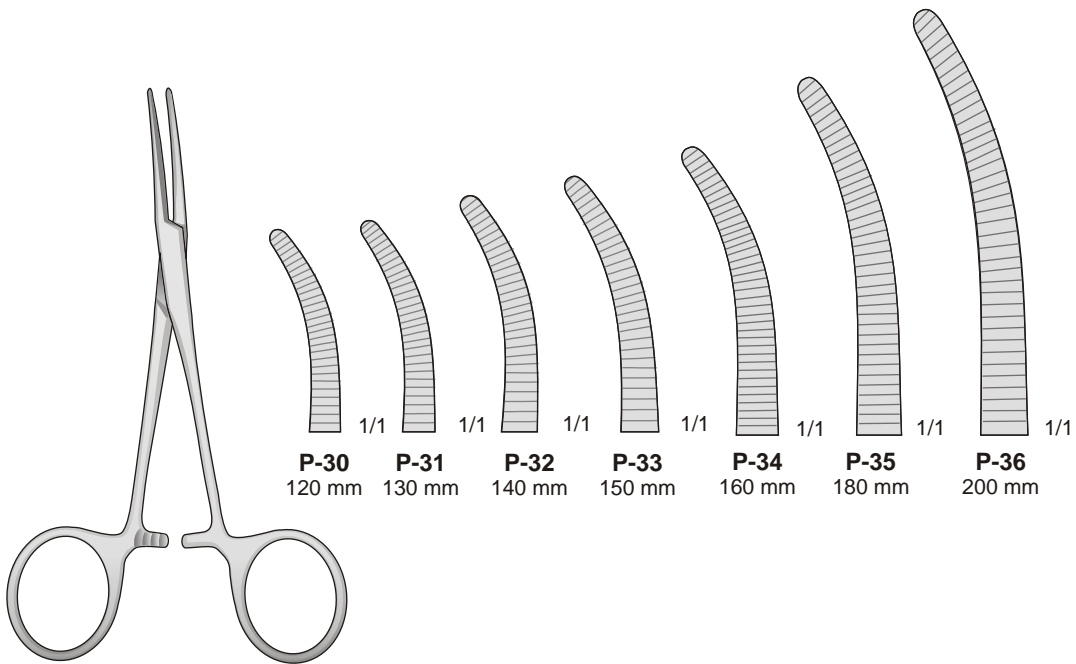

PEAN  
P-30/P-36



Arterienklemmen

Hemostatic forceps

Pinze emostatiche

Pinzas hemostáticas

Pinces hémostatiques

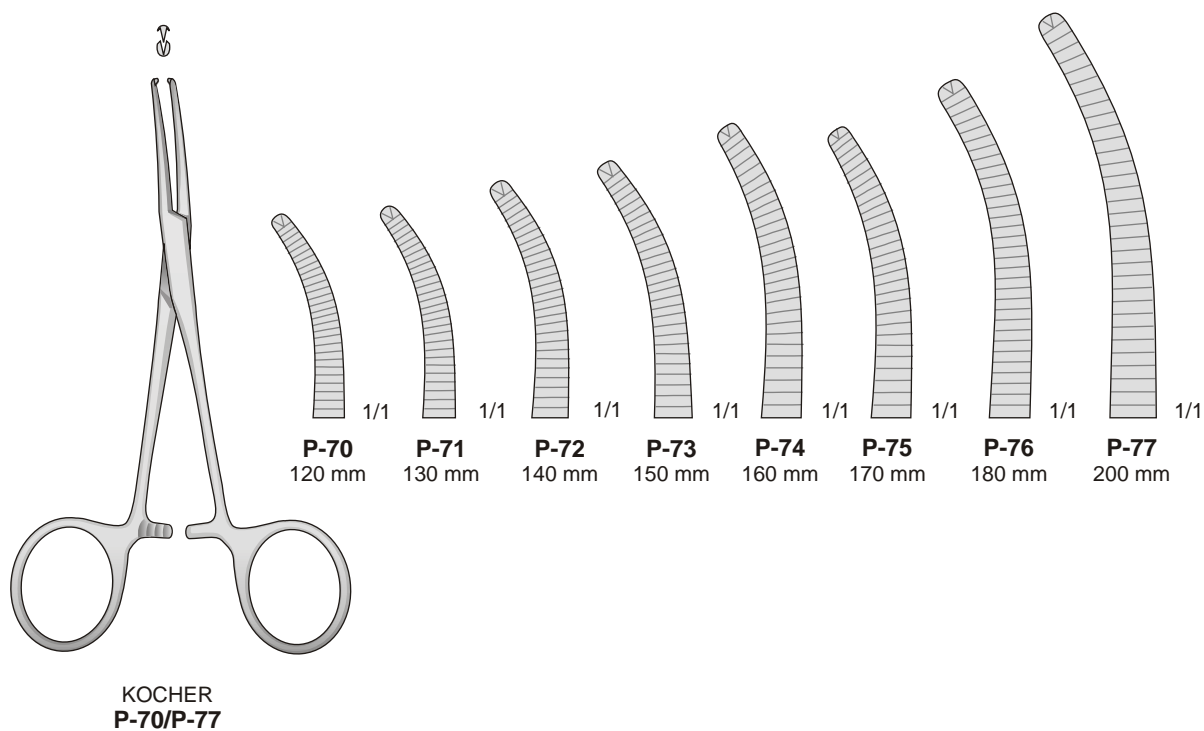
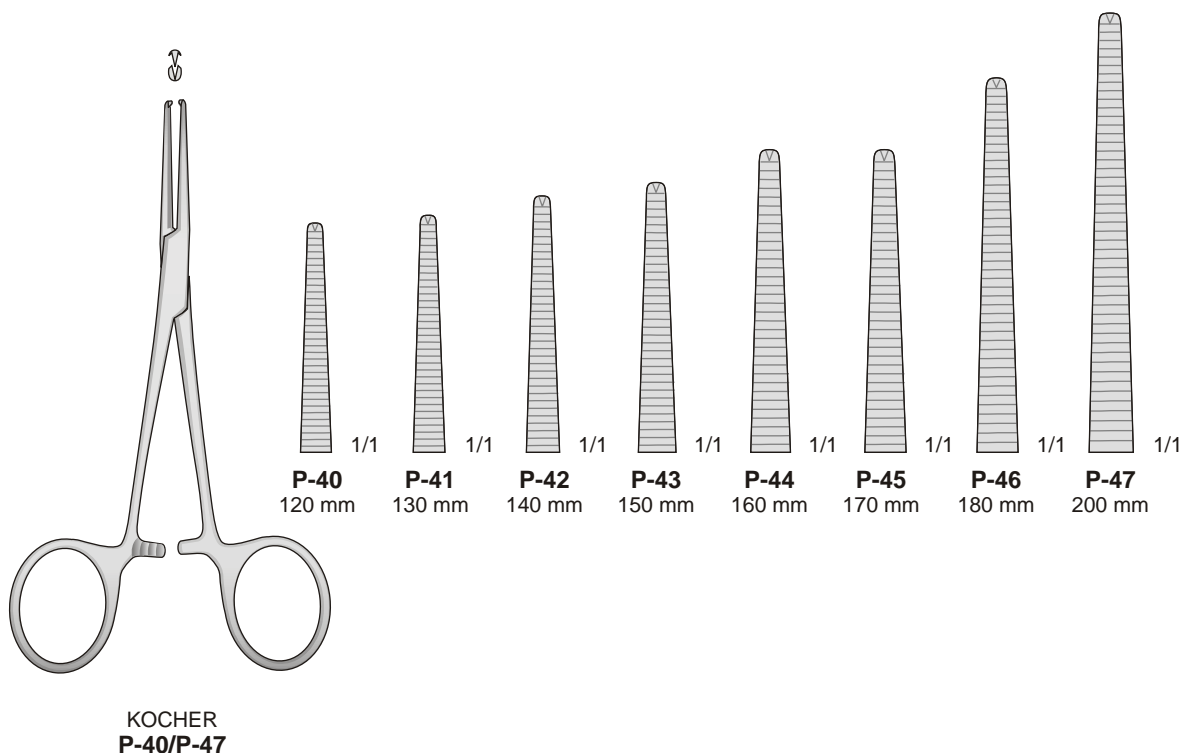

Arterienklemmen

Hemostatic forceps

Pinze emostatiche

Pinzas hemostáticas

Pinces hémostatiques

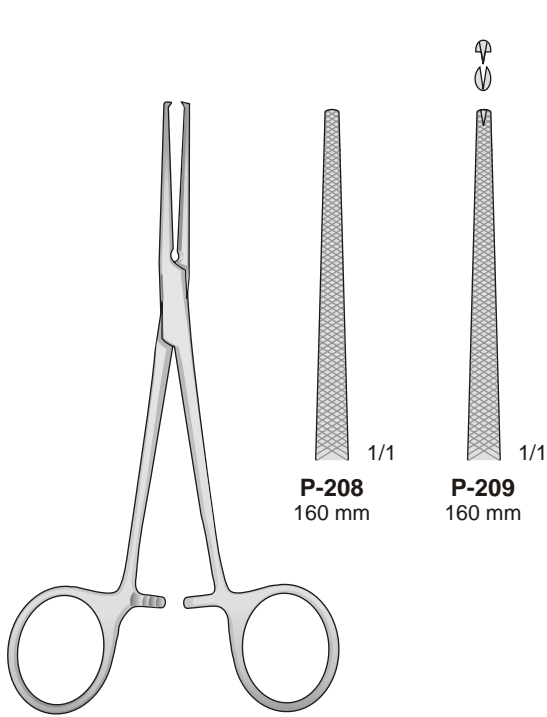

**DIXON-LOVELACE**  
**P-208/P-209**

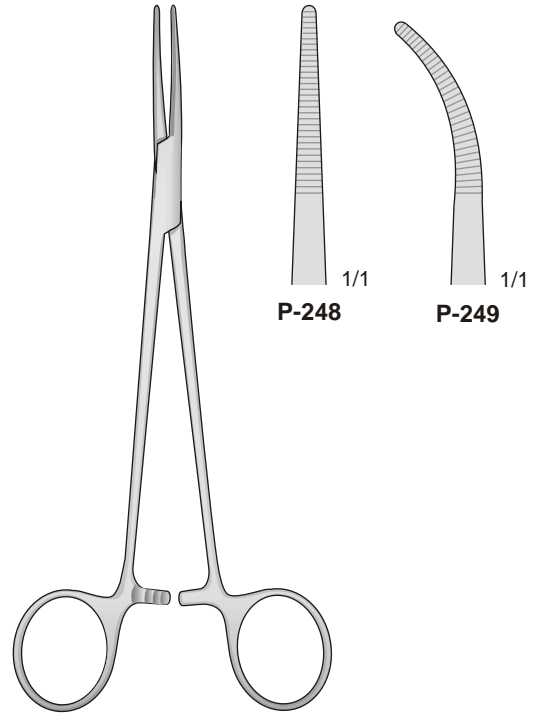

**BIRKETT**  
**P-248/P-249**  
180 mm

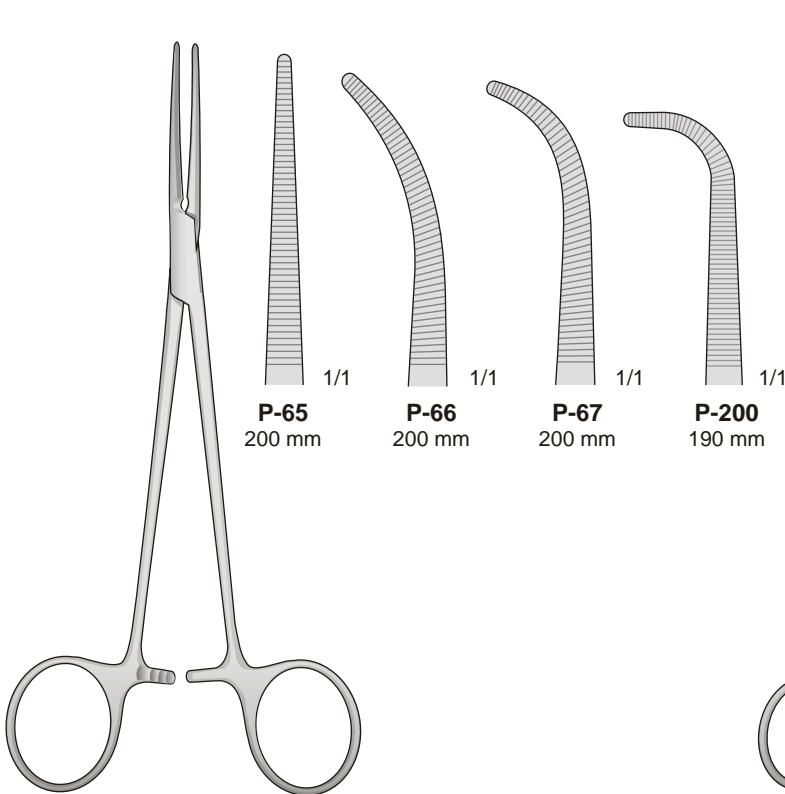

**HEISS**  
**P-65/P-200**

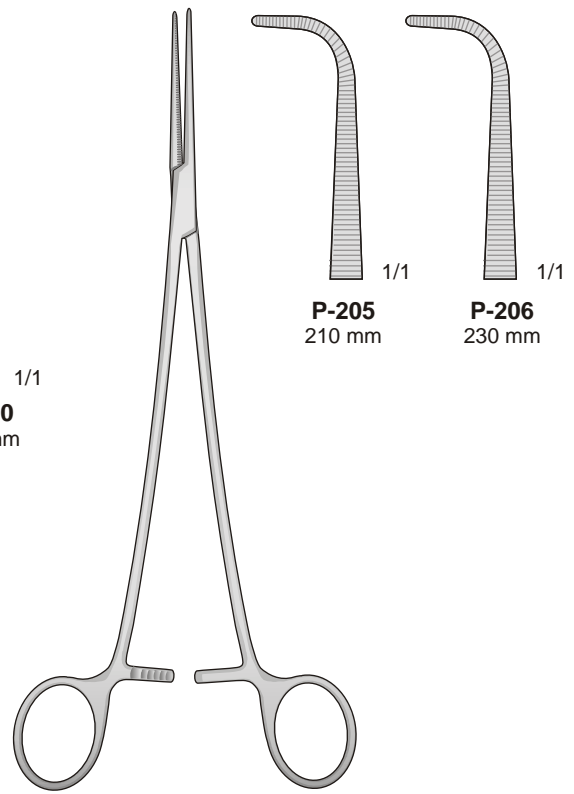

**BENGOLEA**  
**P-205/P-206**

Arterienklemmen  
Präparier und  
Ligaturklemmen

Artery forceps  
for preparation  
and ligature

Pinze emostatiche  
per preparazioni  
e legature

Pinzas hemostáticas  
Preparacion  
y para ligaduras

Pinces hemostáticas  
à disséquer  
et à ligatures

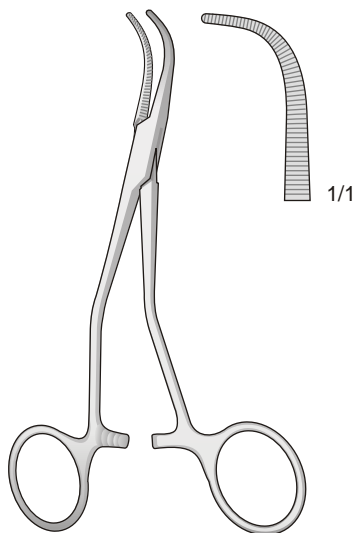

**P-15**  
130 mm

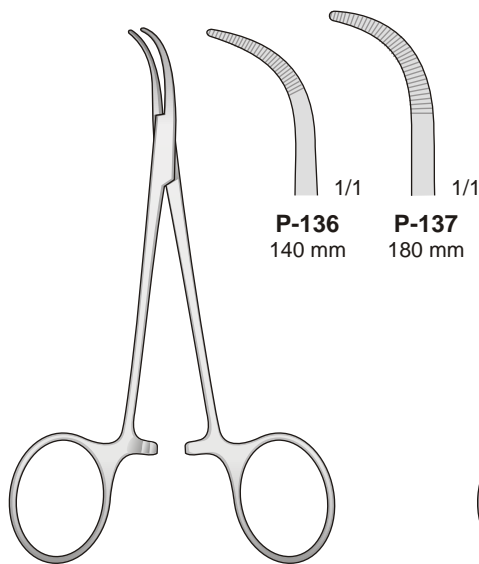

**BABY-MIXTER**  
**P-136/P-137**

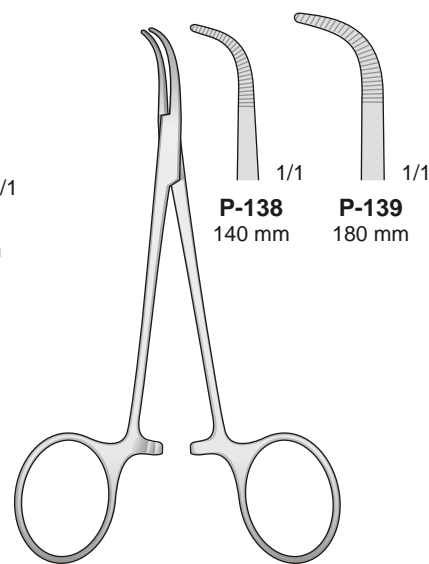

**BABY-ADSON**  
**P-138/P-139**

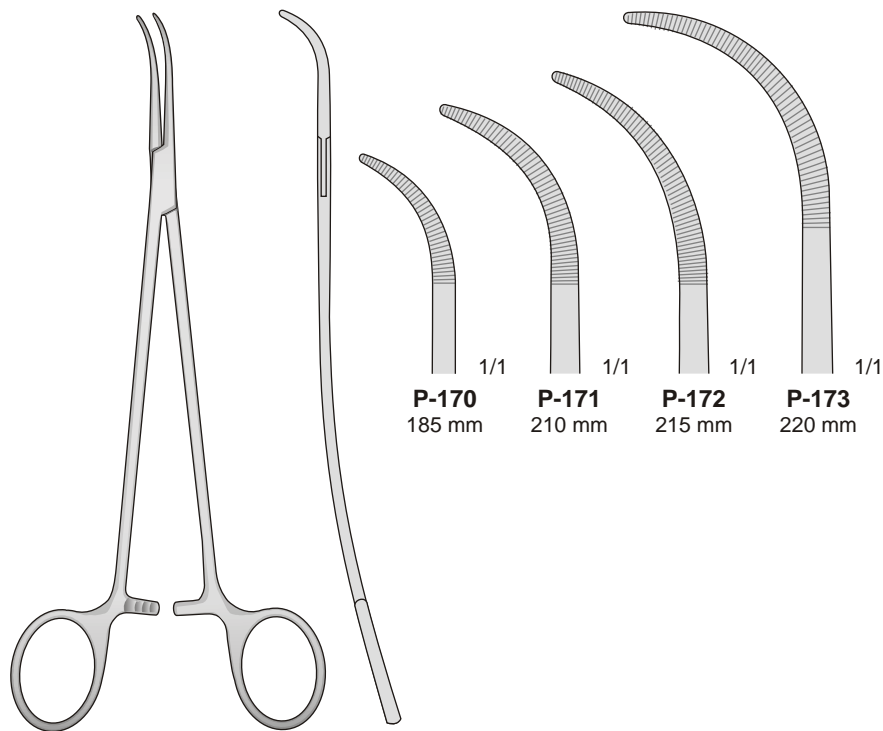

**P-170/P-172**

Arterienklemmen  
Präparier und  
Ligaturklemmen

Artery forceps  
for preparation  
and ligature

Pinze emostatiche  
per preparazioni  
e legature

Pinzas hemostáticas  
Preparacion  
y para ligaduras

Pinces hemostáticas  
à disséquer  
et à ligatures

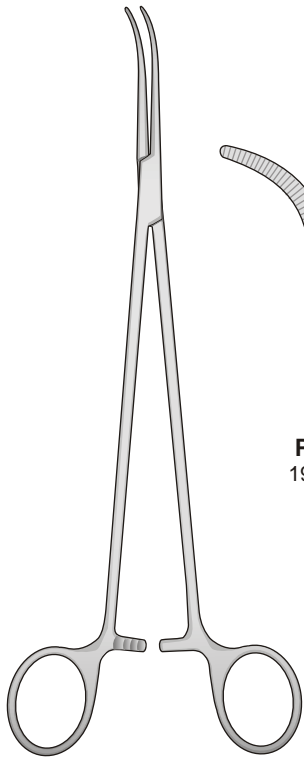

OVERHOLT-GEISSENDORFER  
**P-142/P-148**

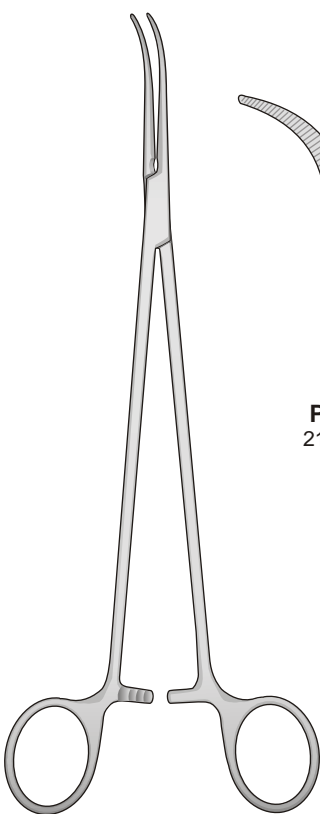
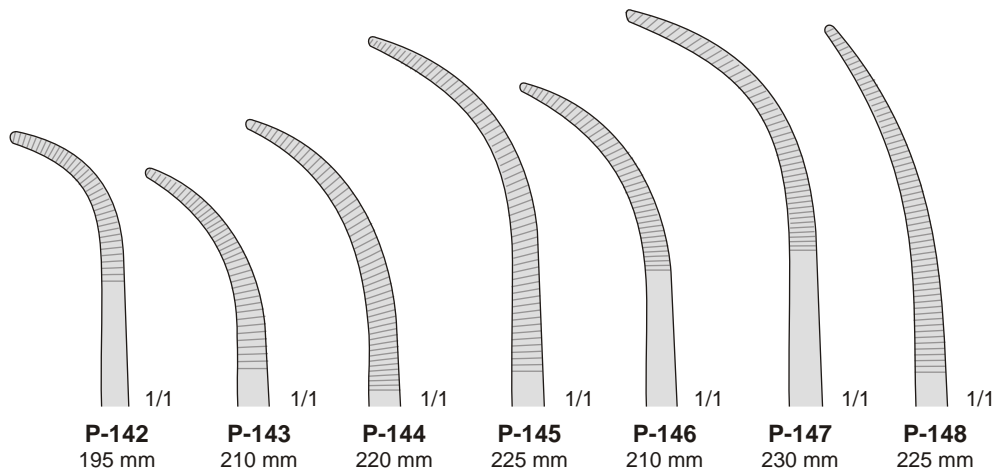

OVERHOLT  
**P-160/P-166**

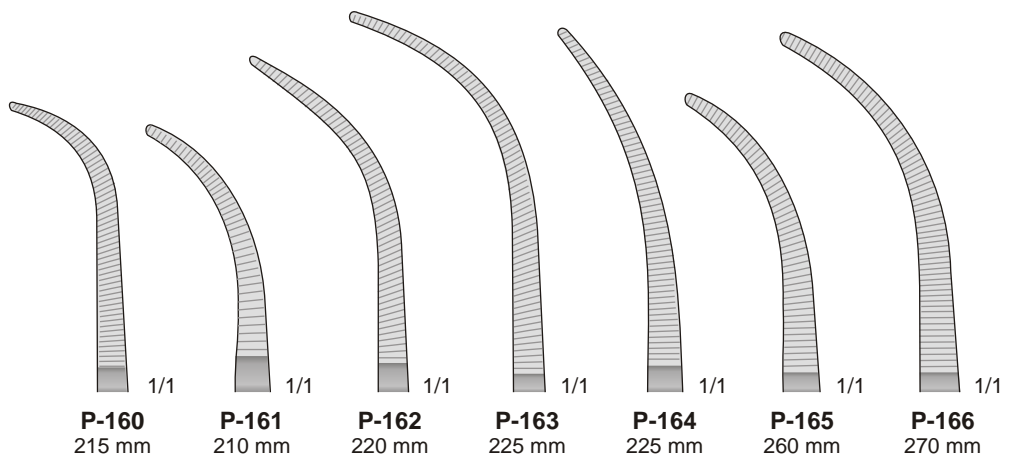

Arterienklemmen  
Präparier und  
Ligaturklemmen

Artery forceps  
for preparation  
and ligature

Pinze emostatiche  
per preparazioni  
e legature

Pinzas hemostáticas  
Preparacion  
y para ligaduras

Pinces hemostáticas  
à disséquer  
et à ligatures

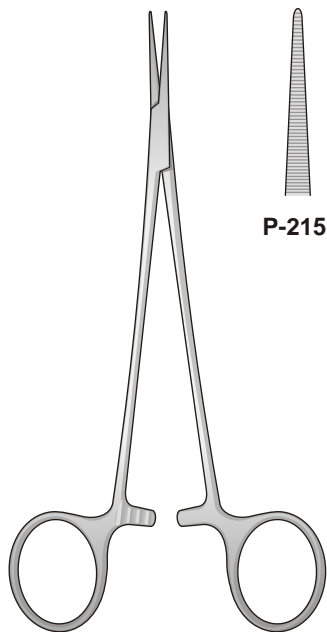

**P-215/P-217**  
160 mm

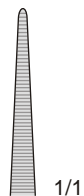

**P-215**

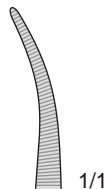

**P-216**

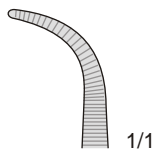

**P-217**

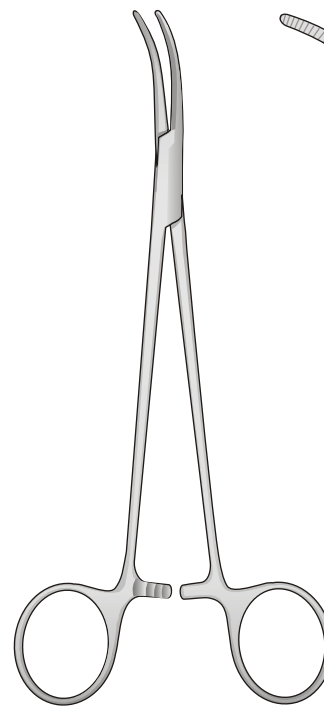

**ROCHESTER-PEAN**  
**P-210**  
180 mm

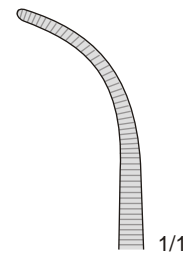

**P-210**

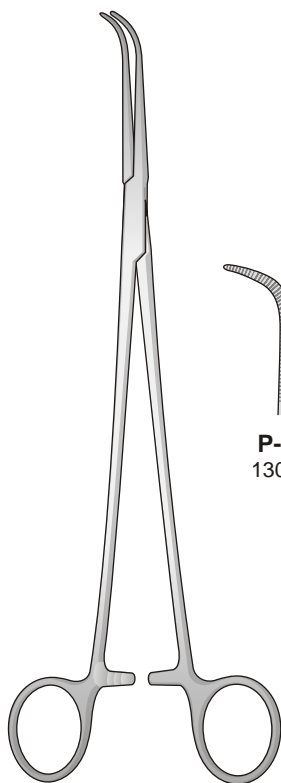

**GEMINI**  
**P-191/P-196**

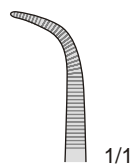

**P-191**  
130 mm

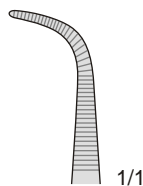

**P-192**  
160 mm

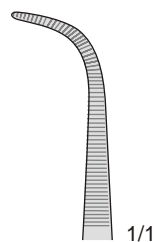

**P-193**  
180 mm

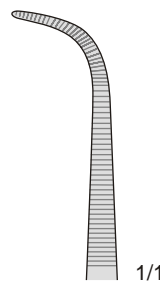

**P-194**  
200 mm

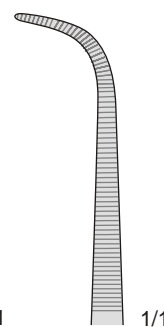

**P-195**  
230 mm

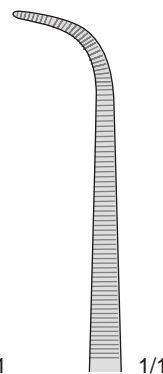

**P-196**  
250 mm

**Isoliert - Insulated - Isolate - Aislante - Isolant  
Monopolar - Monopolari**

mit sterilisierfähiger Kunststoff-Isolierbeschichtung - with autoclavable plastic coated insulated handles  
con rivestimento isolante in plastica sterilizzabile - con recubrimiento aislante de materia plástica esterilizable  
à enduit plastique isolant, stérilisable

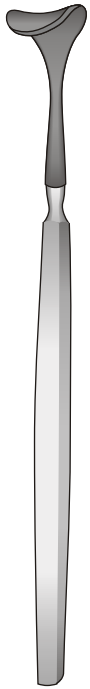

**DESMARES  
BT-490/BT-493  
140 mm**

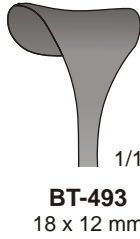
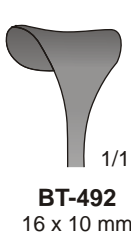

Anatomische Pinzetten, Chirurgische Pinzetten  
Dressing Forceps, Tissue Forceps  
Pinzette anatomiche e chirurgiche  
Pinzas anatómicas, Pinzas quirúrgicas  
Pincas anatomiques, Pincas chirurgicales

es

es

es

**BD-194IS**  
100 mm

**BD-10IS**  
145 mm

**BD-273IS**  
155 mm

**BD-20IS**  
200 mm

**BD-23IS**  
230 mm

**BD-277IS**  
250 mm

**BD-24IS**  
250 mm



SADIQ SURGICAL CO.

Catalogue 2015 / 2016



5

Nadelhalter  
Needle holders  
Port'aghi  
Portaagujas  
Porte aiguilles





Mikro Nadelhalter

Micro Needle Holders

Micro port'aghi

Micro portaagujas

Micro porte aiguilles

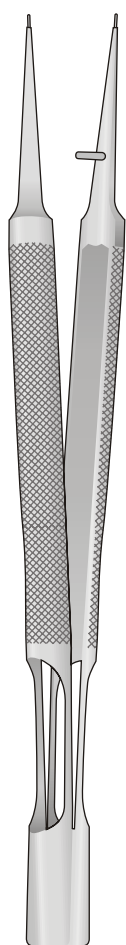
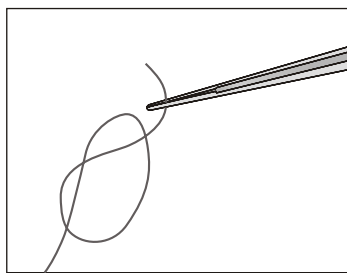

**BROCK  
FD-203**  
130 mm

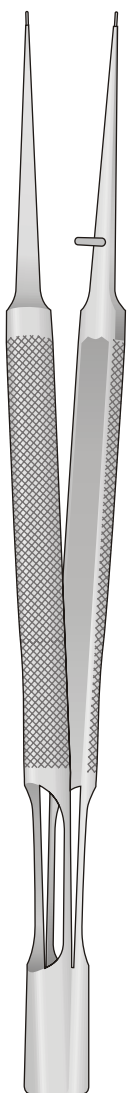
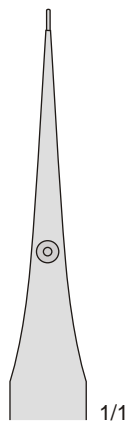

**BROCK  
FD-204**  
150 mm

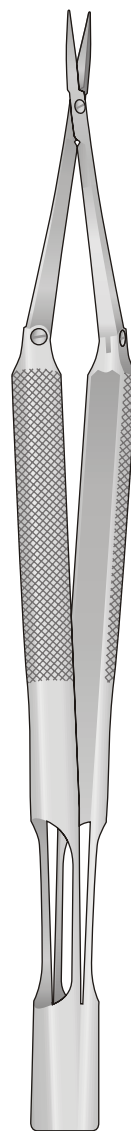
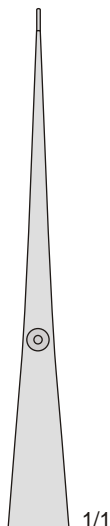

**BROCK  
FD-211**  
150 mm

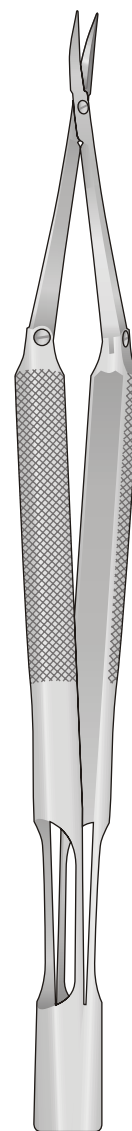
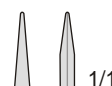

**BROCK  
FD-213**  
150 mm



Mikro Nadelhalter

Micro Needle Holders

Micro port'aghi

Micro portaagujas

Micro porte aiguilles

Glattes Maul  
Smooth jaws  
Con morso liscio  
Mandibula lisa  
A' mors lisses

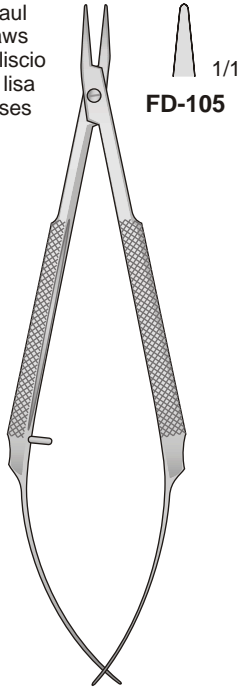

**FD-105**



**FD-106**

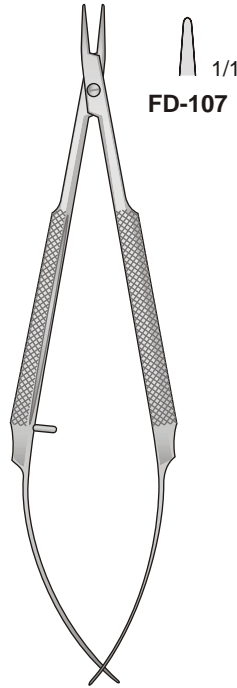

**FD-107**



**FD-108**

**FD-105/FD-106**  
110 mm

**FD-107/FD-108**  
110 mm

Glattes Maul  
Smooth jaws  
Con morso liscio  
Mandibula lisa  
A' mors lisses

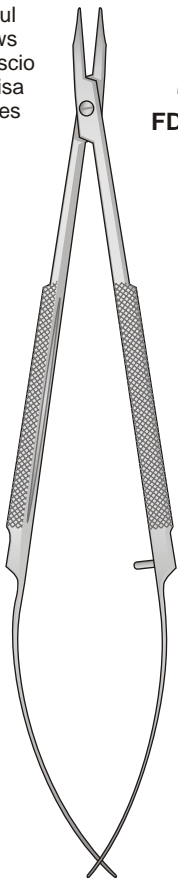

**FD-113**



**FD-114**

**FD-113/FD-114**  
150 mm

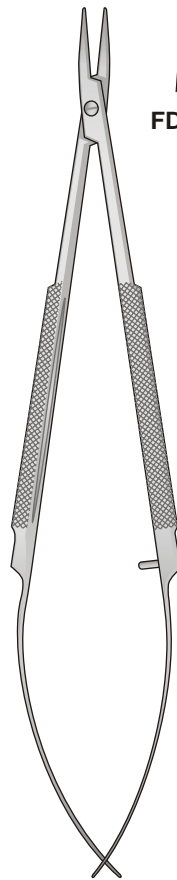

**FD-115**



**FD-116**

**FD-115/FD-116**  
150 mm

Feingerieftes Maul  
Fine serrated jaws  
Con morso zigrinato fine  
Bocas estriadas finas  
Mors stries fins

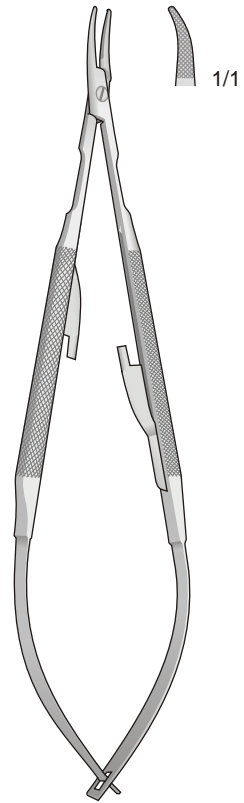

**BARRAQUER**  
**FD-24**  
135 mm

Glattes Maul - Smooth jaws  
 Con morso liscio - Mandibula lisa  
 A' mors lisses

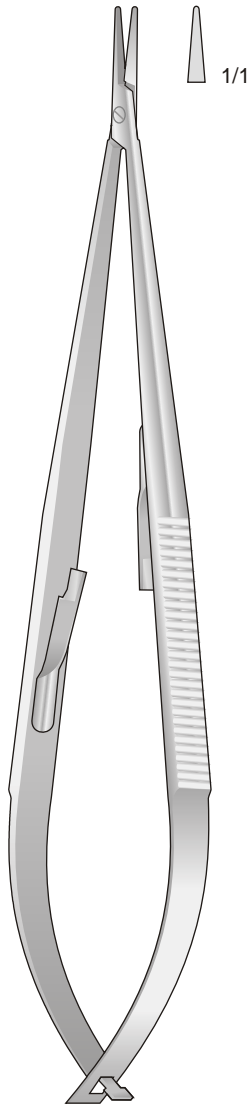

**JACOBSON**  
**FD-63**  
 180 mm

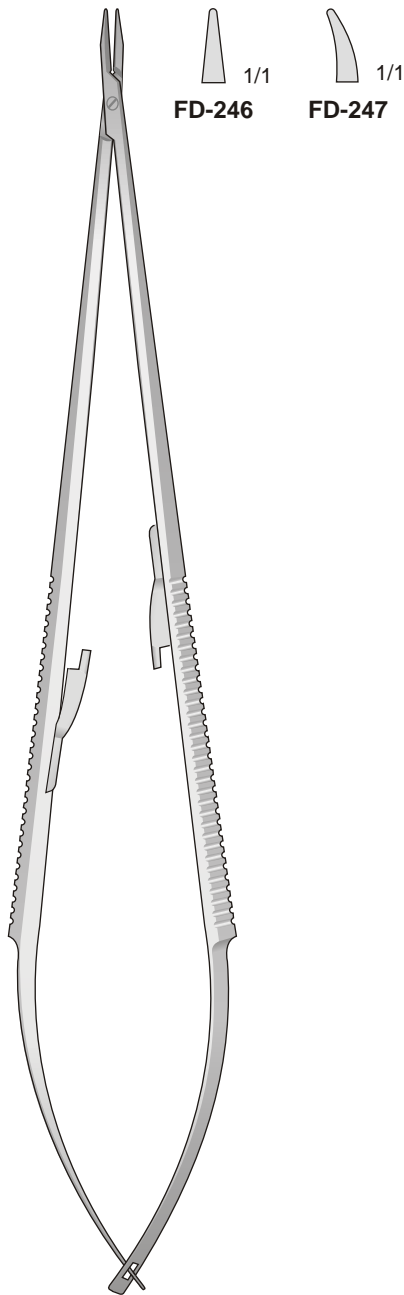

**FD-246/FD-247**  
 225 mm

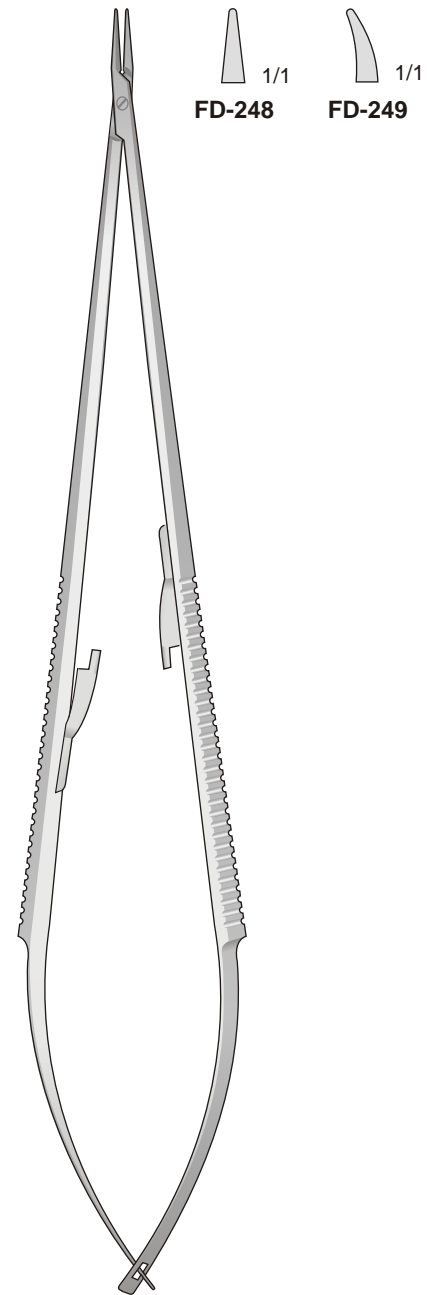

**FD-248/FD-249**  
 225 mm

Mikro Nadelhalter



Micro Needle Holders

Micro port'aghi

Micro portaagujas

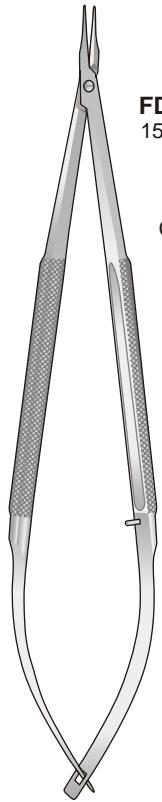
Micro porte aiguilles





 1/1  
**FD-152**  
 150 mm  
 1/1  
**FD-153**  
 150 mm

Glattes Maul  
 Smooth jaws  
 Con morso liscio  
 Mandibula lisa  
 A' mors lisses

**BARRAQUER**  
**FD-152/FD-153**  
 150 mm

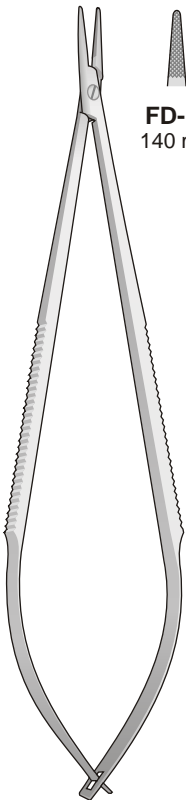

Glattes Maul  
 Smooth jaws  
 Con morso liscio  
 Mandibula lisa  
 A' mors lisses



 1/1  
**FD-14**  
 140 mm  
 1/1  
**FD-16**  
 140 mm

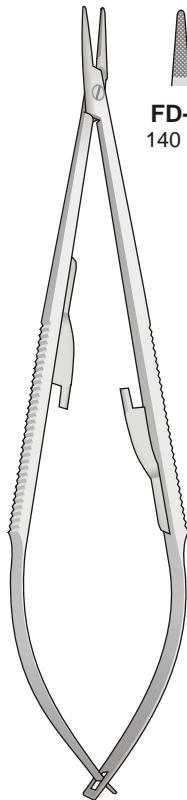

**FD-14/FD-16**  
 140 mm

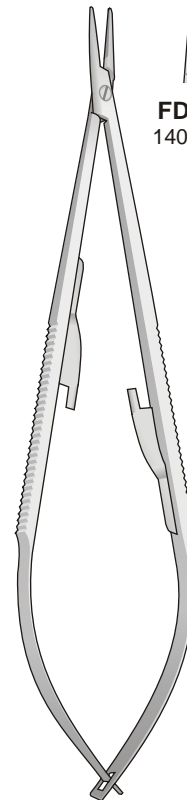

 1/1  
**FD-18**  
 140 mm  
 1/1  
**FD-20**  
 140 mm

**CASTROVIEJO**  
**FD-18/FD-20**  
 140 mm



 1/1  
**FD-17**  
 140 mm  
 1/1  
**FD-19**  
 140 mm

**CASTROVIEJO**  
**FD-17/FD-19**  
 140 mm

Nadelhalter mit Hartmetalleinlagen  
 Needle Holders with tungsten-carbide inserts  
 Portaghi con inserti al tungsteno  
 Portaagujas con plaquitas de carburo de tungsteno  
 Porte aiguilles avec plaquettes en carbure de tungstène

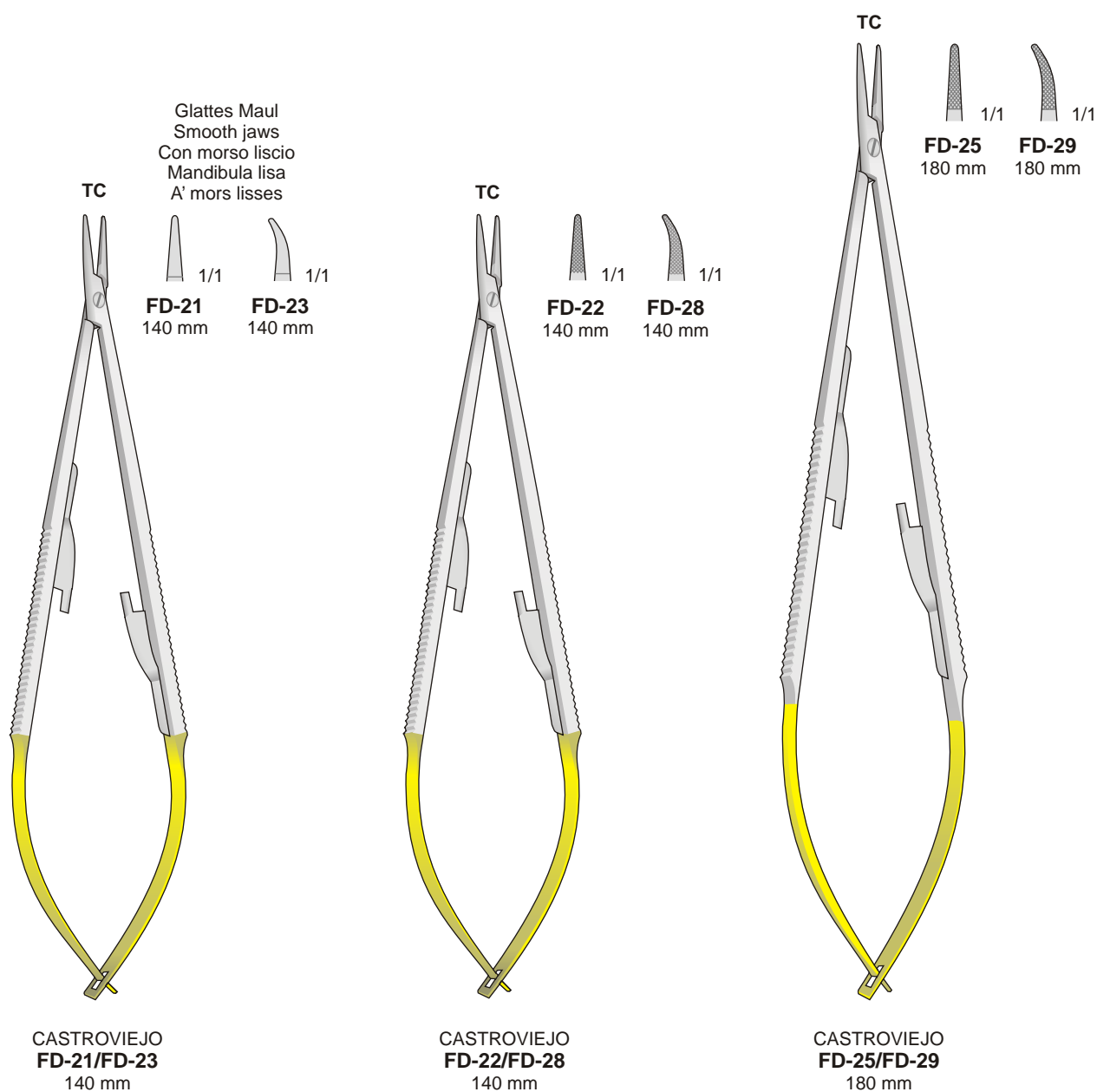

Nadelhalter mit Hartmetalleinlagen  
 Needle Holders with tungsten-carbide inserts  
 Portaghi con inserti al tungsteno  
 Portaagujas con plaquetas de carburo de tungsteno  
 Porte aiguilles avec plaquettes en carbure de tungstène

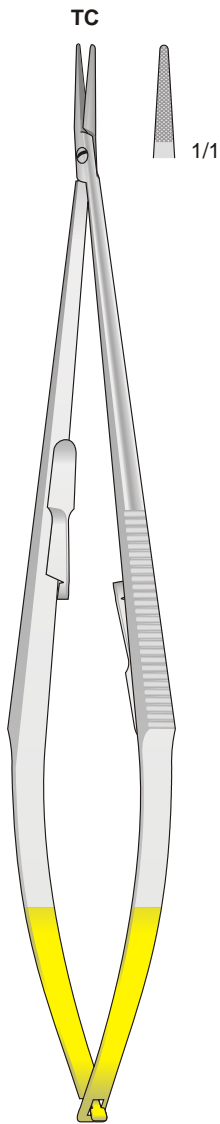

**CASTROVIEJO  
 FD-27  
 215 mm**

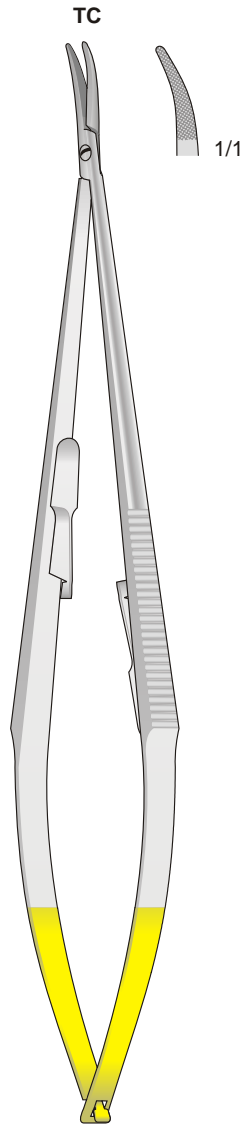

**CASTROVIEJO  
 FD-128  
 215 mm**

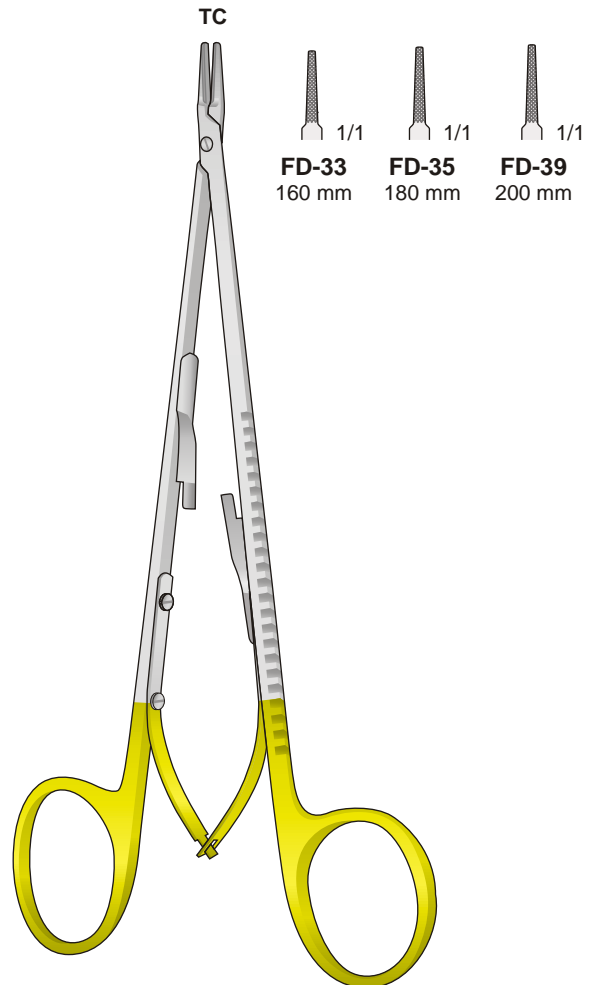

**DIETRICH  
 FD-33/FD-39**

Glattes Maul  
With smooth jaws  
Con morso liscio  
Con mandibula lisa  
Avec mors lisses

Glattes Maul  
With smooth jaws  
Con morso liscio  
Con mandibula lisa  
Avec mors lisses

Nadelhalter mit Hartmetalleinlagen  
Needle Holders with tungsten-carbide inserts  
Portaghi con inserti al tungsteno  
Portaagujas con plaquetas de carburo de tungsteno  
Porte aiguilles avec plaquettes en carbure de tungstène

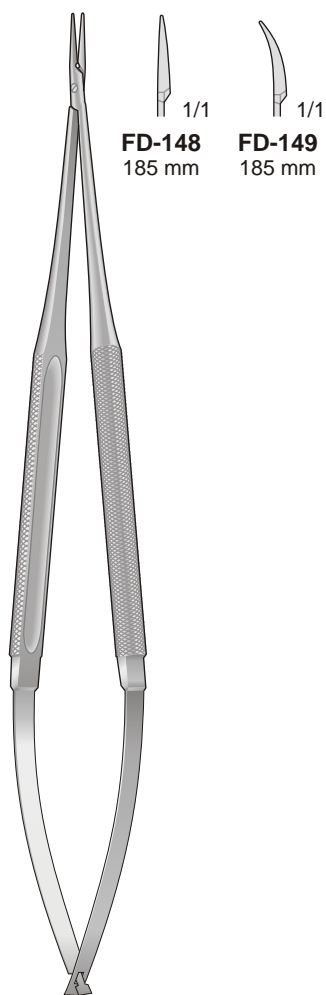

**FD-148**  
185 mm

**FD-149**  
185 mm

**FD-148/FD-149**  
185 mm

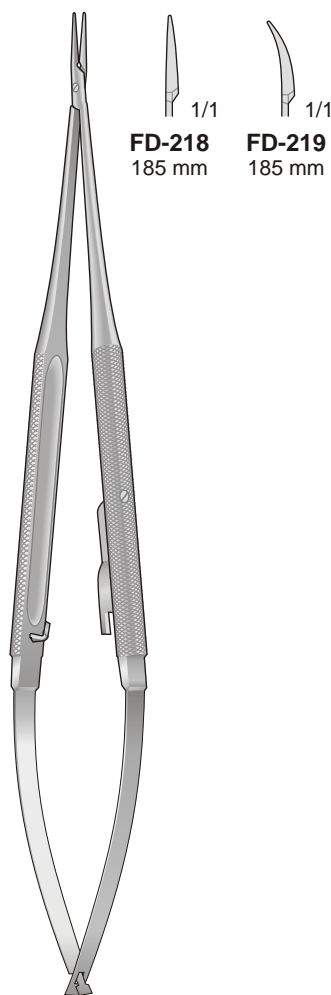

**FD-218**  
185 mm

**FD-219**  
185 mm

**FD-218/FD-219**  
185 mm

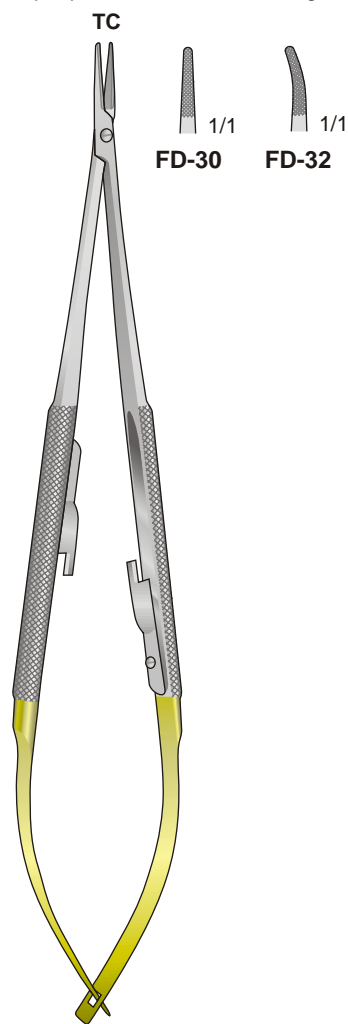

**FD-30**

**FD-32**

**JACOBSON**  
**FD-30/FD-32**  
180 mm

Nadelhalter mit Hartmetalleinlagen  
 Needle Holders with tungsten-carbide inserts  
 Portaghi con inserti al tungsteno  
 Portaagujas con plaquitas de carburo de tungsteno  
 Porte aiguilles avec plaquettes en carbure de tungstène

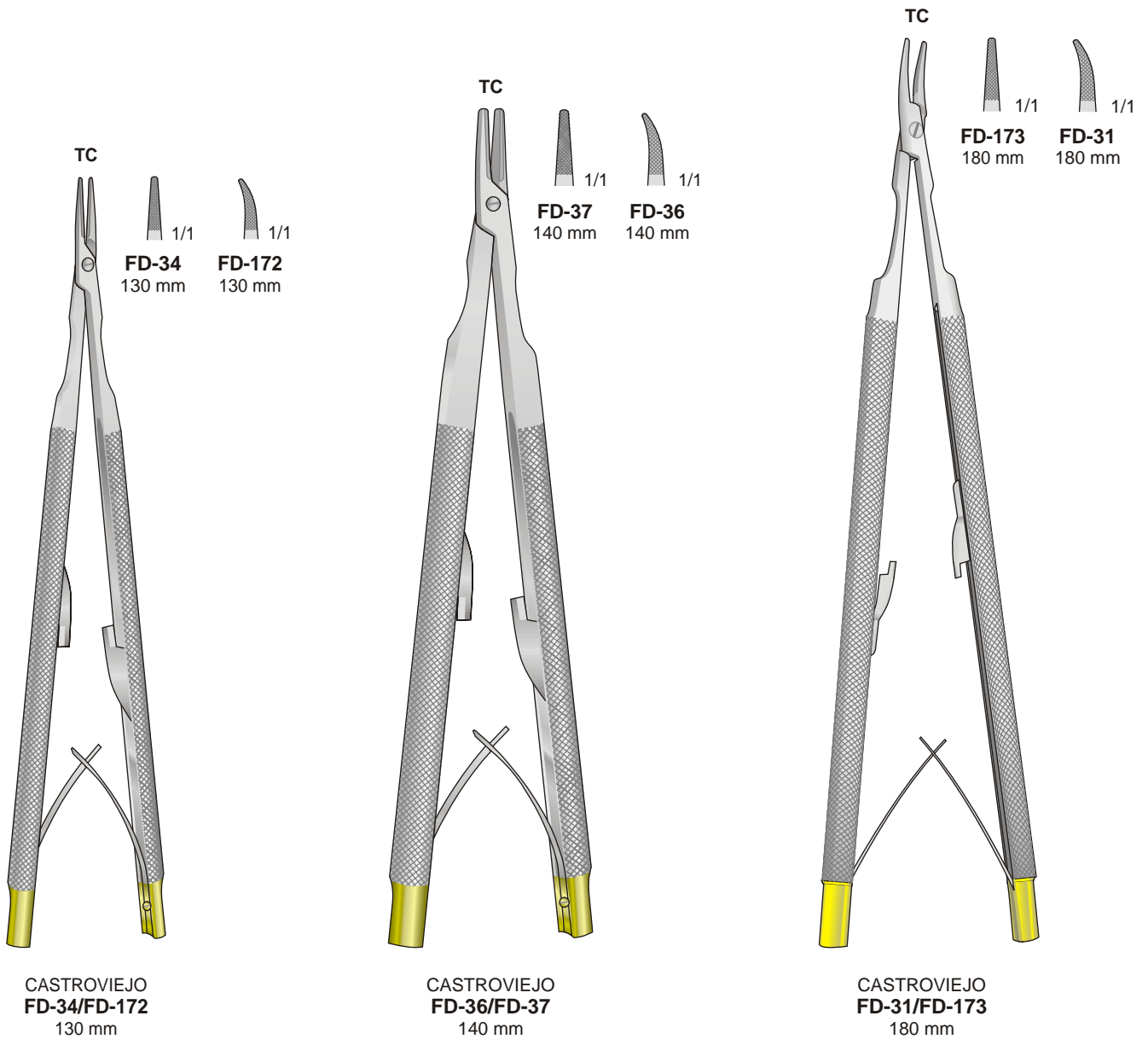



Nadelhalter

Needle Holders

Port'aghi

Portaagujas

Porte aiguilles

Glattes Maul  
With smooth jaws  
Con morso liscio  
Con mandibula lisa  
Avec mors lisses

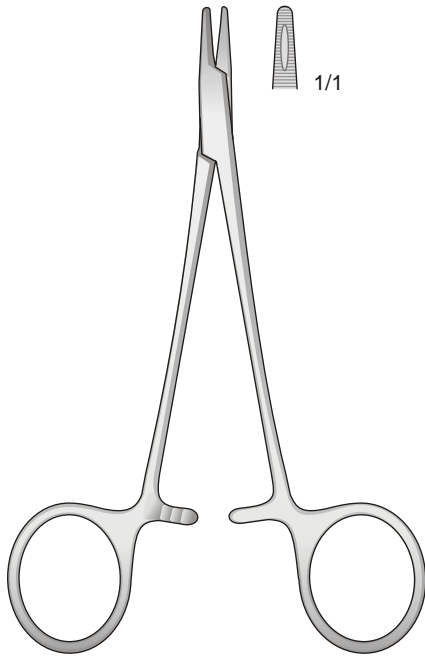

**DERF**  
**PH-39**  
125 mm

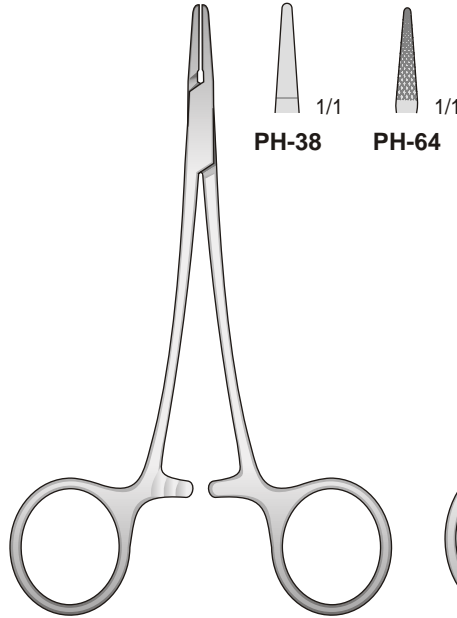

**PH-38/PH-64**  
120 mm

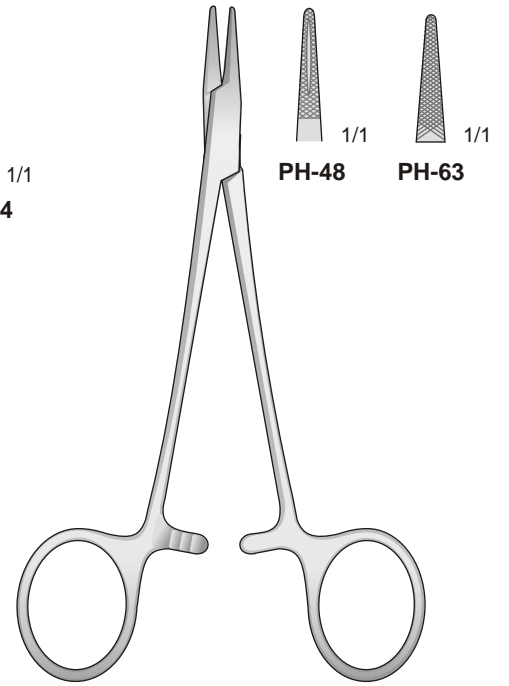

**HALSEY**  
**PH-48/PH-63**  
130 mm

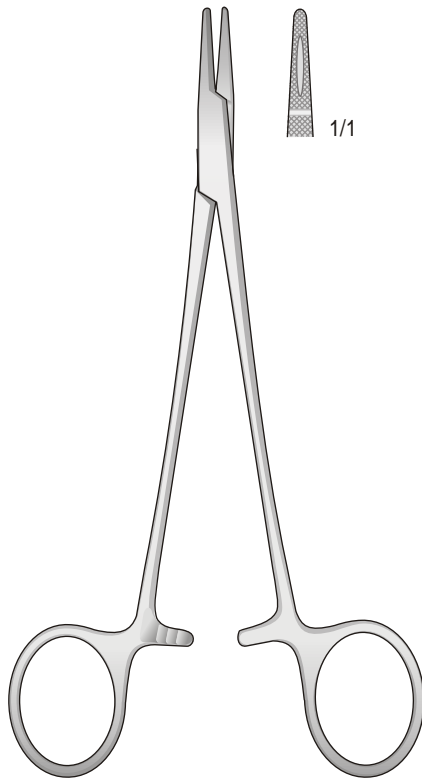

**CRILE-WOOD**  
**PH-61**  
150 mm

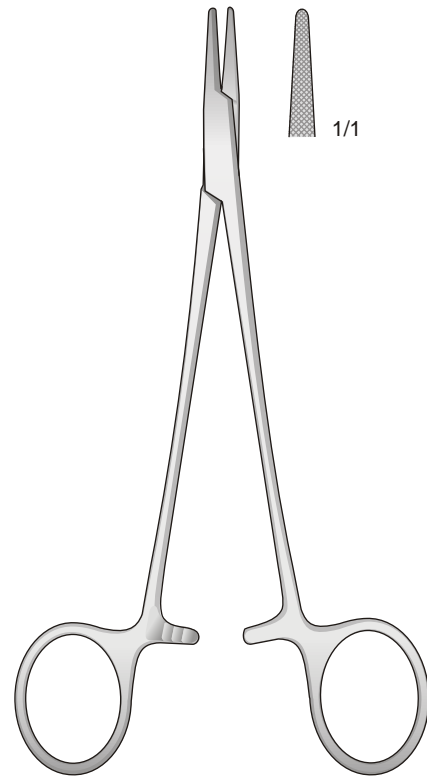

**CRILE-MURRAY**  
**PH-62**  
150 mm

Nadelhalter

Needle Holders

Port'aghi

Portaagujas

Porte aiguilles

Schlankes Modell - Delicate pattern - Modello fine  
Modelo delegado - Modèle fin

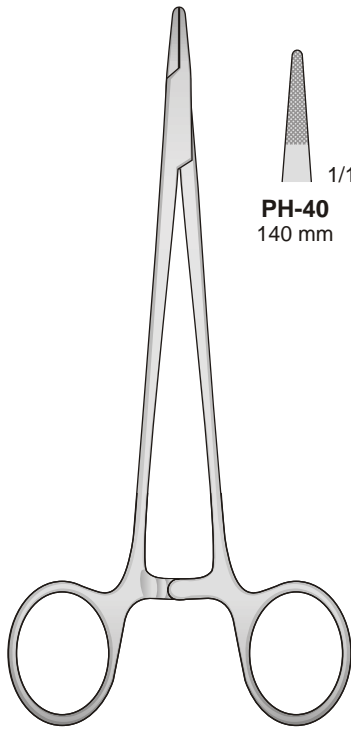

**MAYO-HEGAR  
PH-40/PH-45**

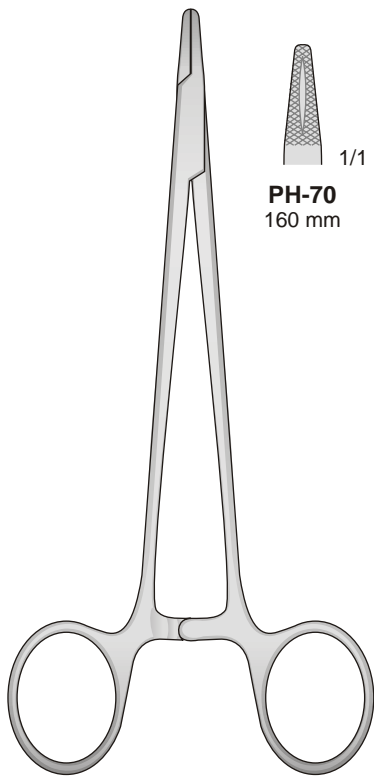
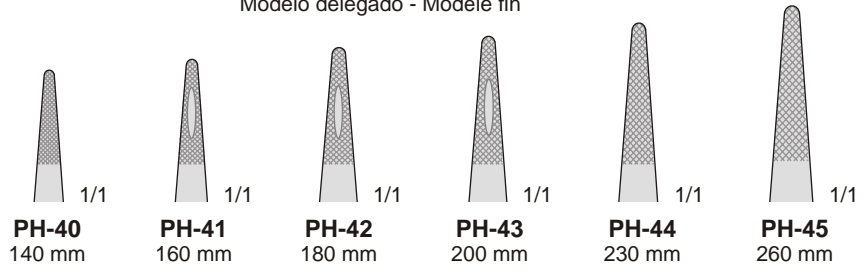

**HEGAR  
PH-70/PH-78**

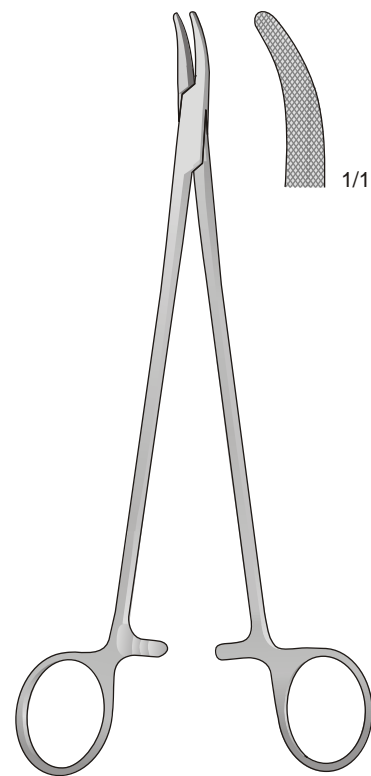
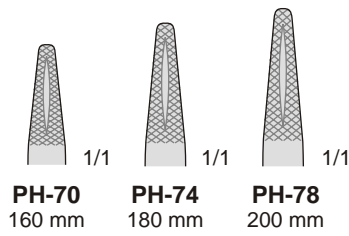

**HEANEY (HEGAR)  
PH-52  
200 mm**

Nadelhalter

Needle Holders

Port'aghi

Portaagujas

Porte aiguilles

Nadelhalter mit Schere - Needle holders with scissors  
 Port'aghi con forbici - Portaagujas con tijeras  
 Porte aiguilles avec ciseaux

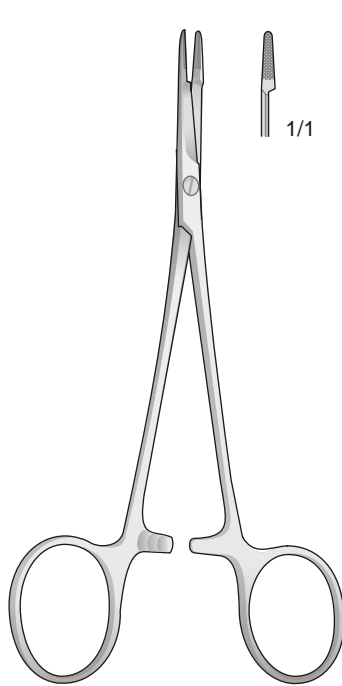

MINI-OLSEN-HEGAR  
**BM-61**  
 120 mm

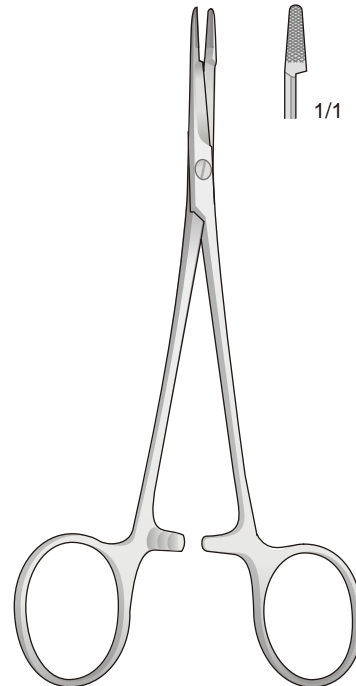

OLSEN-HEGAR  
**BM-62**  
 140 mm

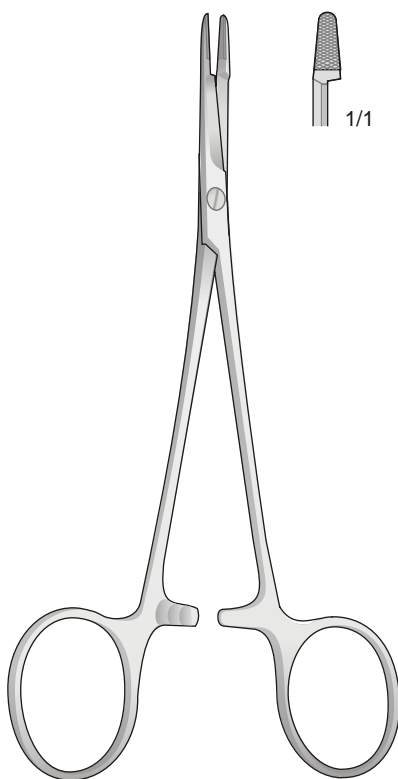

OLSEN-HEGAR  
**BM-63**  
 170 mm

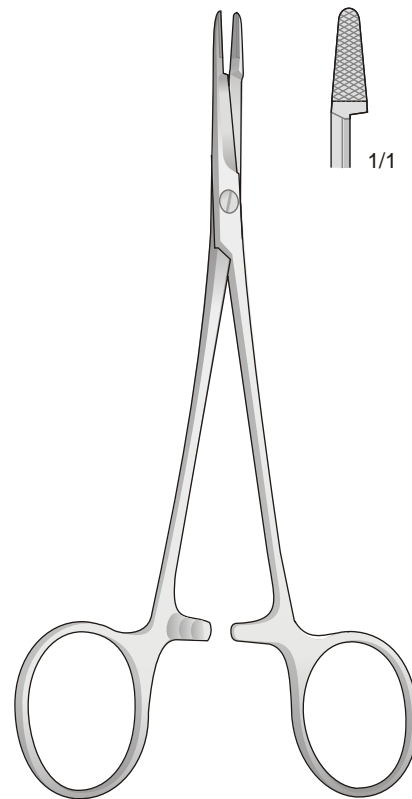

OLSEN-HEGAR  
**BM-64**  
 190 mm

Nadelhalter mit Schere

Needle holders with scissors

Port'aghi con forbici

Portaagujas con tijeras

Porte aiguilles avec ciseaux

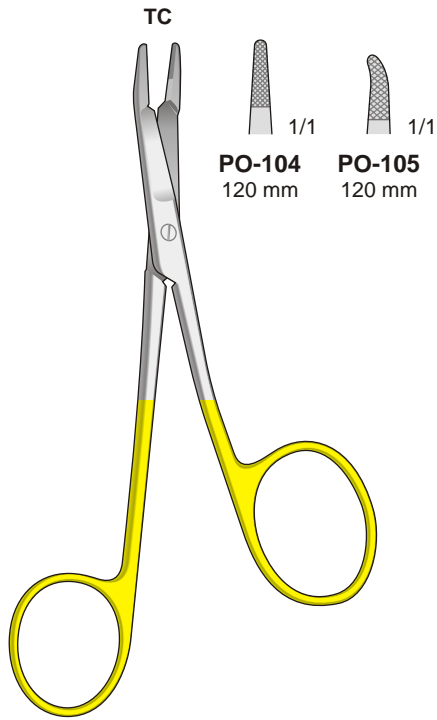

**FOSTER-GILLIES**  
**PO-104/PO-105**  
120 mm

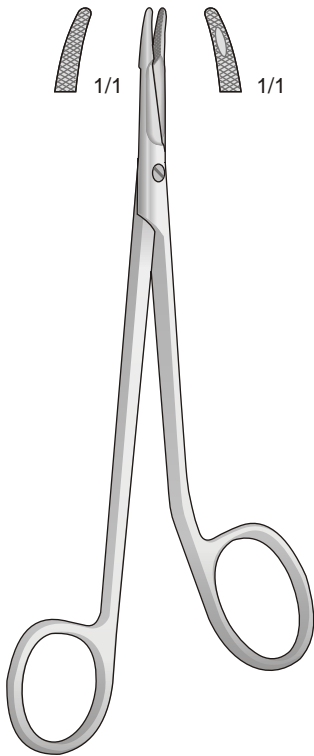

**MINI-GILLIES**  
**PO-59**  
145 mm

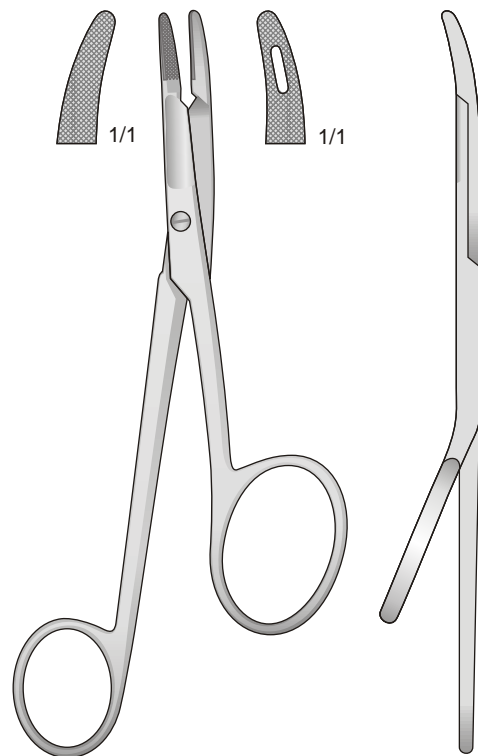

**GILLIES**  
**PO-89**  
160 mm

Nadelhalter

Needle Holders

Port'aghi

Portaagujas

Porte aiguilles

Nadelhalter mit Hartmetalleinlagen - Needle Holders with tungsten-carbide inserts  
 Portaghi con inserti al tungsteno - Portaagujas con plaquitas de carburo de tungsteno  
 Porte aiguilles avec plaquettes en carbure de tungstène

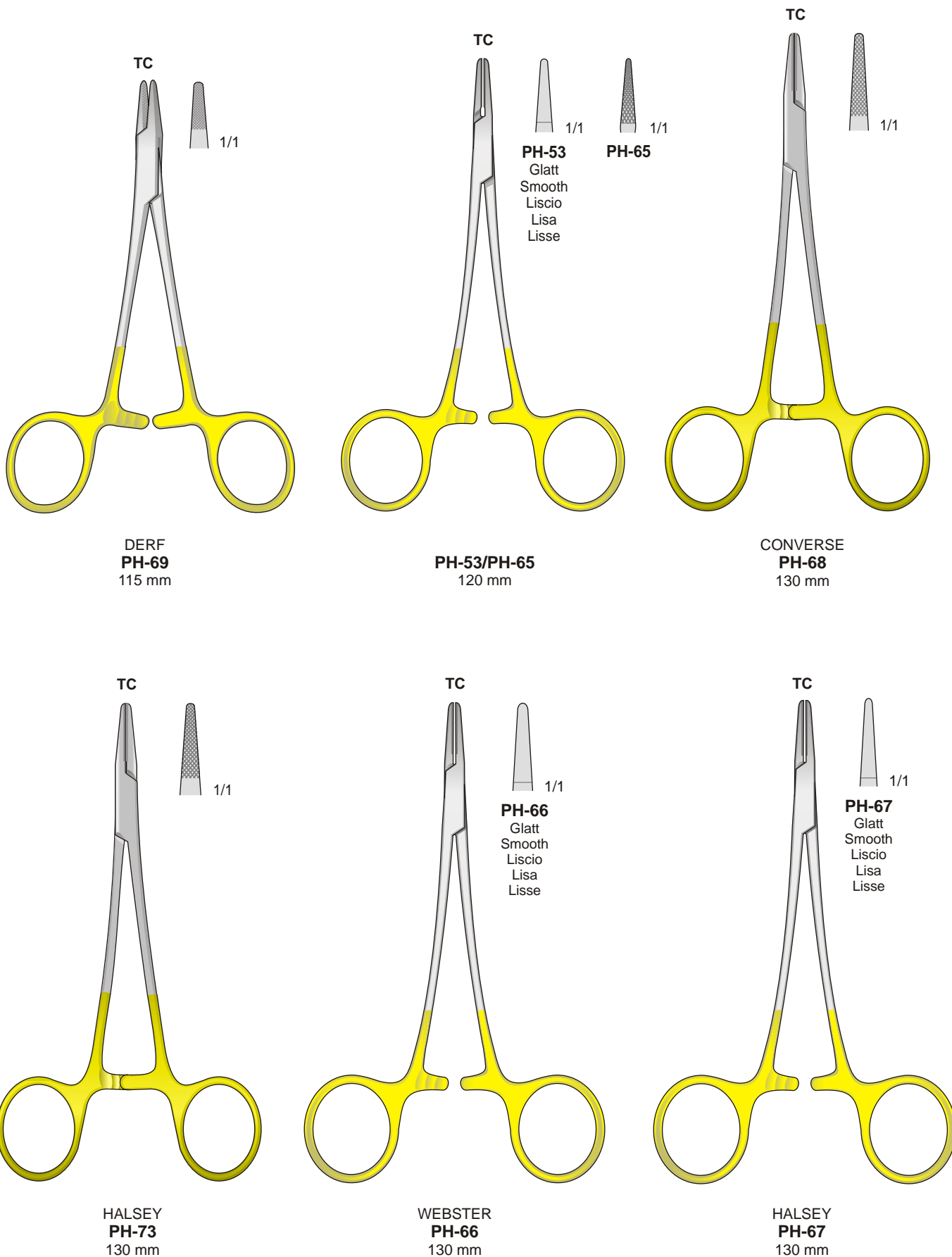

Nadelhalter

Needle Holders

Port'aghi

Portaagujas

Porte aiguilles

Nadelhalter mit Hartmetalleinlagen - Needle Holders with tungsten-carbide inserts  
 Portaghi con inserti al tungsteno - Portaagujas con plaquitas de carburo de tungsteno  
 Porte aiguilles avec plaquettes en carbure de tungstène

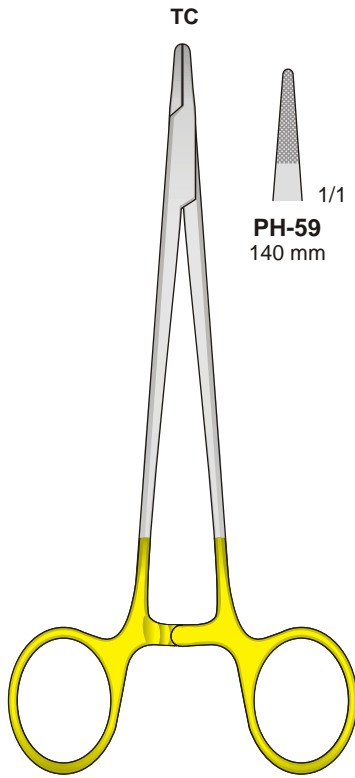

HEGAR  
PH-59/PH-76

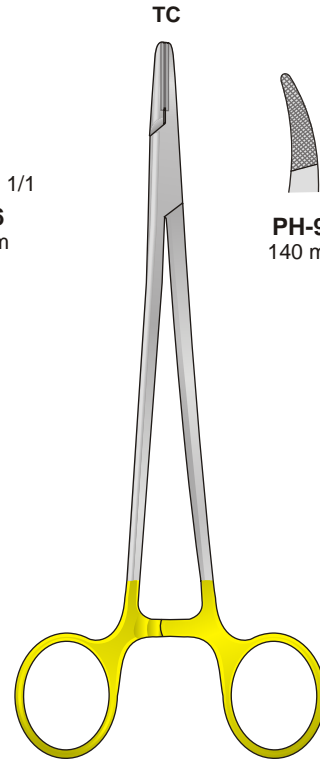
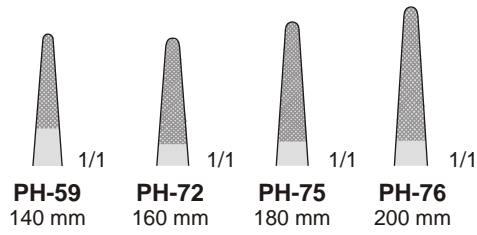

MAYO-HEGAR-HEANEY  
PH-95/PH-97

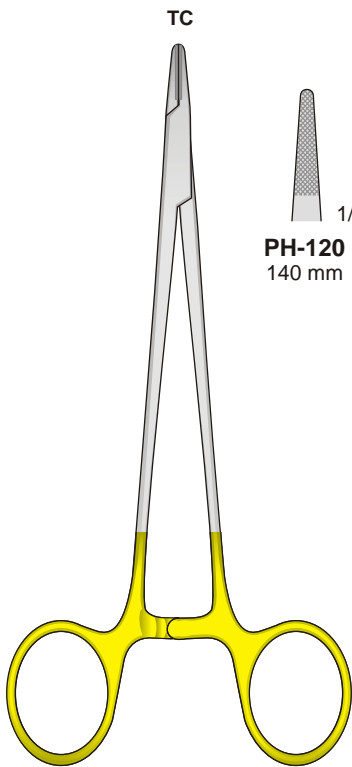
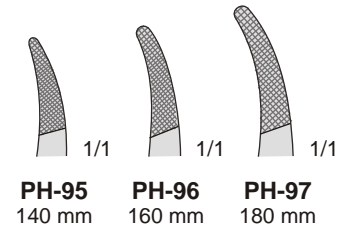

MAYO-HEGAR  
PH-120/PH-125

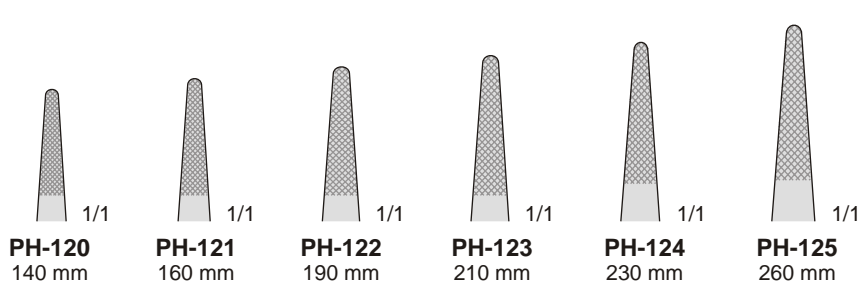

Nadelhalter

Needle Holders

Port'aghi

Portaagujas

Porte aiguilles

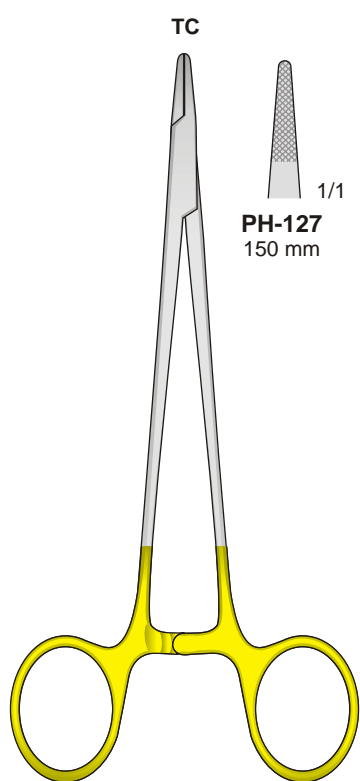

MAYO-HEGAR-FINO  
PH-127/PH-129

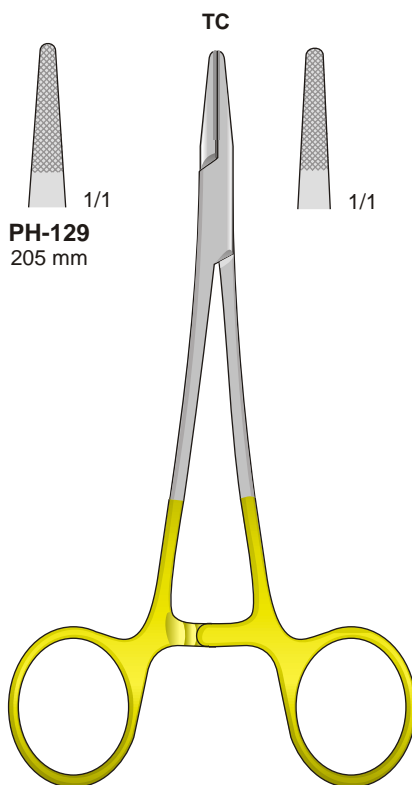
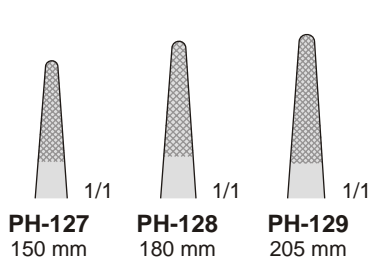

CRILE-WOOD  
PH-77  
180 mm

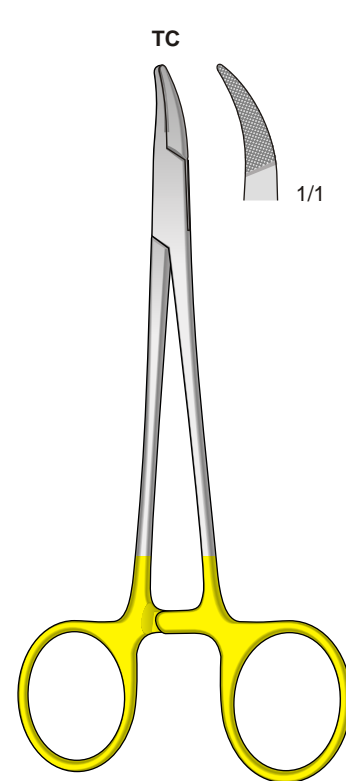

CRILE-WOOD  
PH-90  
150 mm

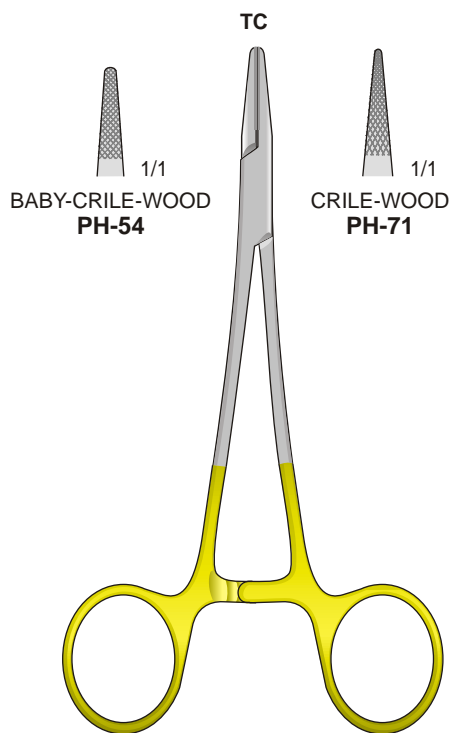

CRILE-WOOD  
PH-54/PH-71  
150 mm

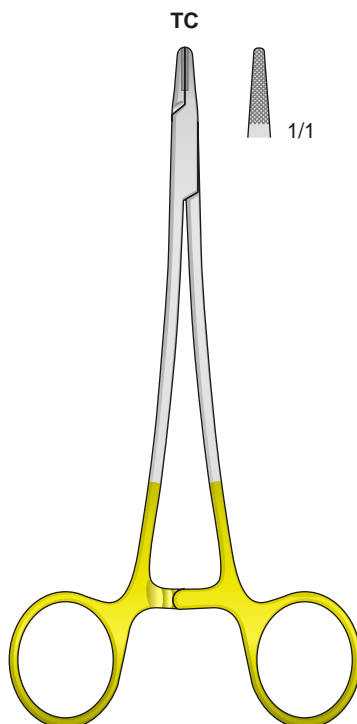

PH-79  
145 mm

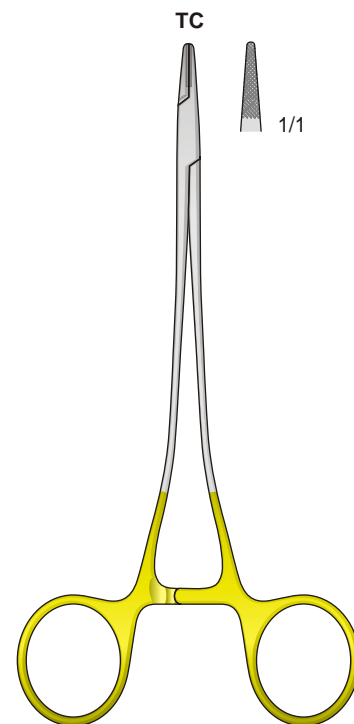

PH-85  
150 mm

Nadelhalter mit Schere

Needle holders with scissors

Port'aghi con forbici

Portaagujas con tijeras

Porte aiguilles avec ciseaux

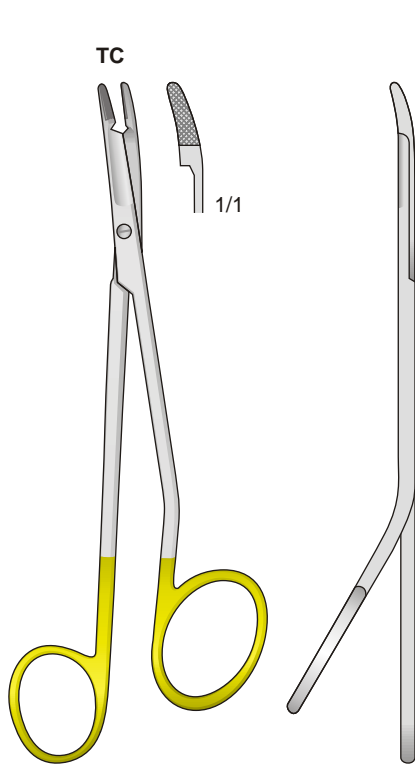

**MINI-GILLIES  
PO-99  
145 mm**

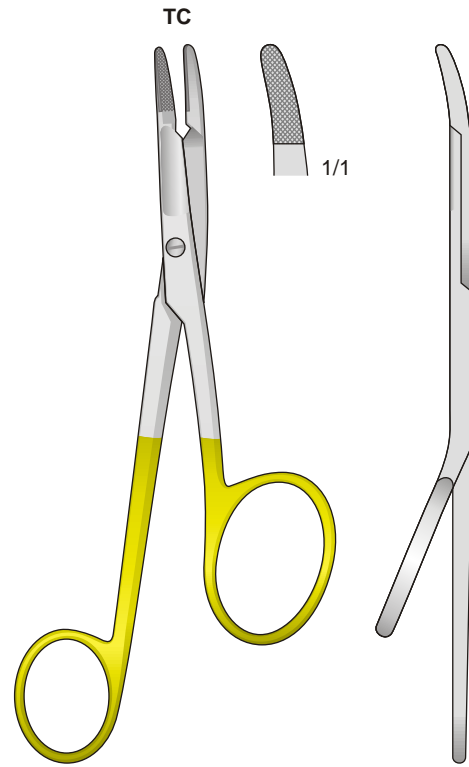

**GILLIES  
PO-97  
160 mm**

Für Linkshänder - Left Handed  
Per mancini - Pour gauche - Para zurdos

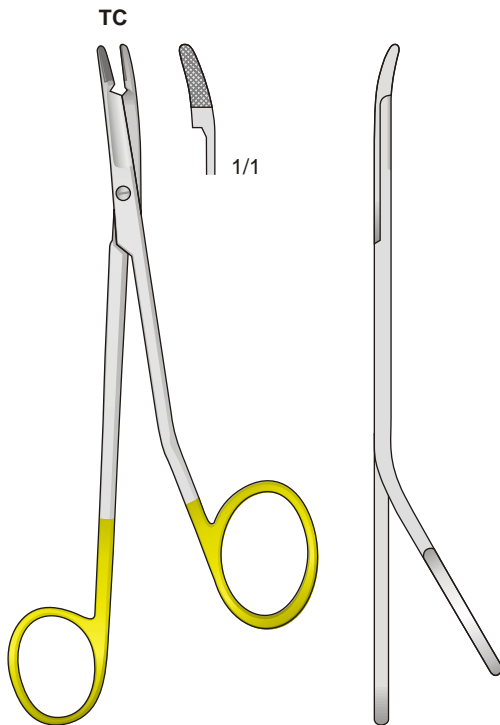

**MINI-GILLIES  
PO-99L  
145 mm**

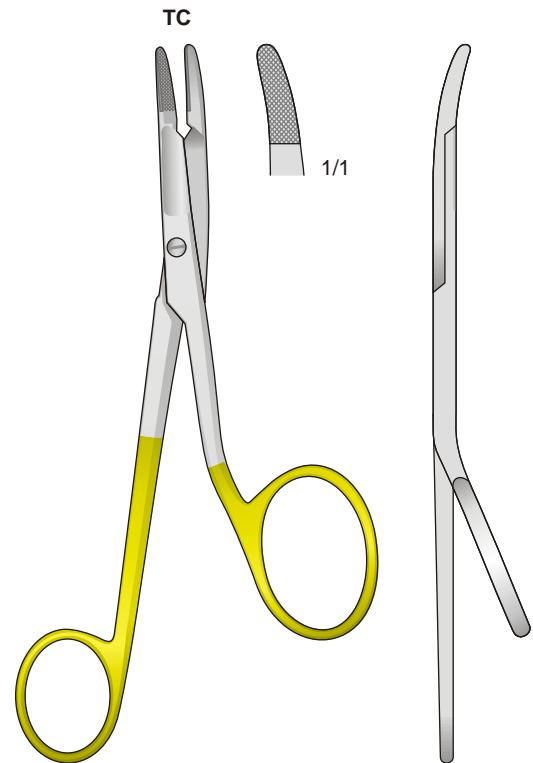

**GILLIES  
PO-97L  
160 mm**



Nadelhalter

Needle Holders

Port'aghi

Portaagujas

Porte aiguilles

Nadelhalter mit Hartmetalleinlagen - Needle Holders with tungsten-carbide inserts  
 Portaghi con inserti al tungsteno - Portaagujas con plaquitas de carburo de tungsteno  
 Porte aiguilles avec plaquettes en carbure de tungstène

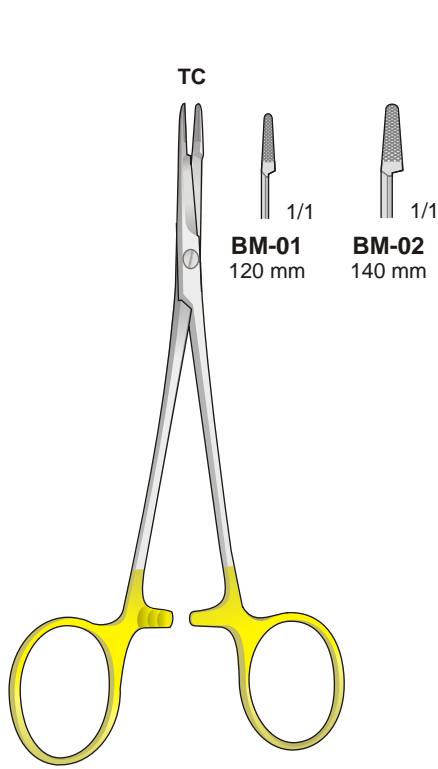

OLSEN-HEGAR  
BM-01/BM-02

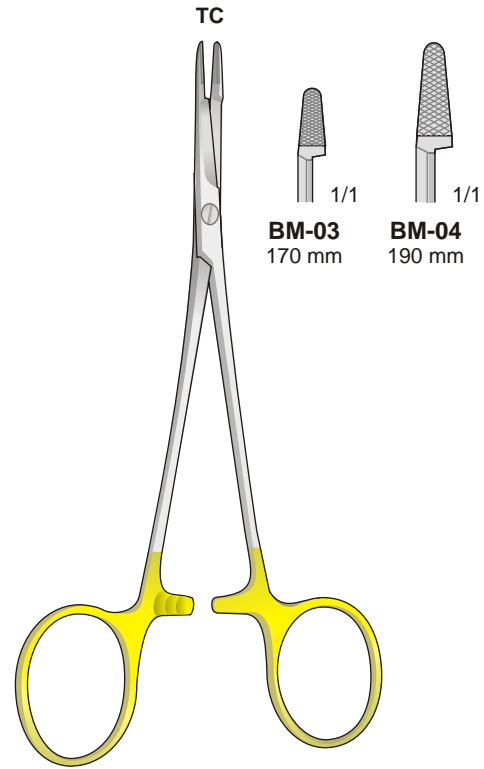

OLSEN-HEGAR  
BM-03/BM-04

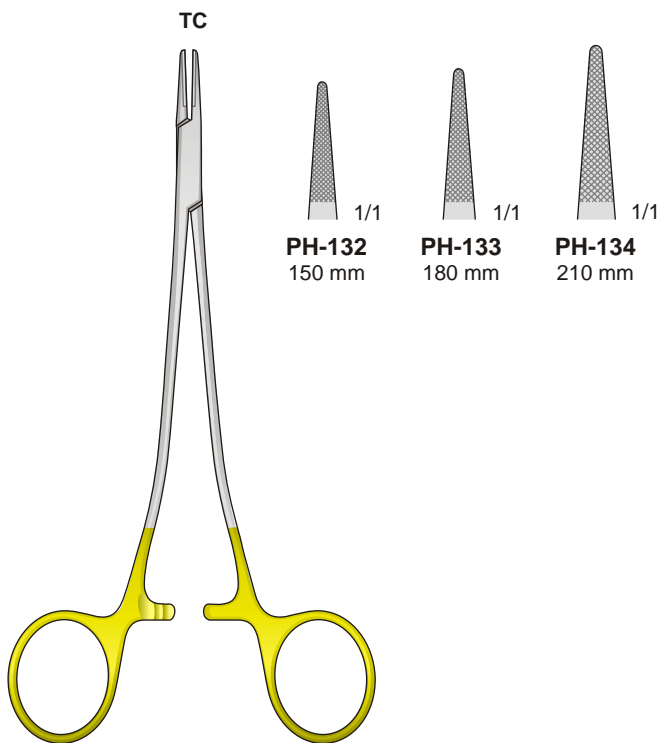

SAROT  
PH-132/PH-134

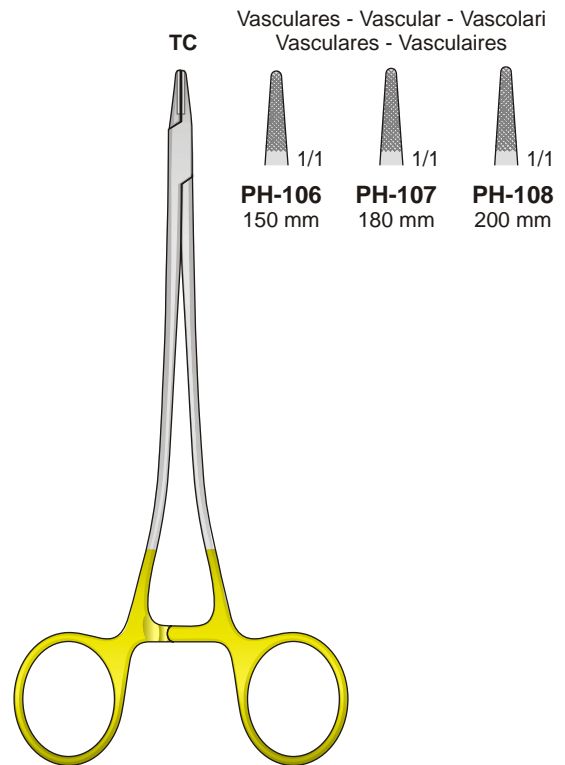

SWEDESH MOD.  
PH-106/PH-108

Nadelhalter mit Hartmetalleinlagen - Needle Holders with tungsten-carbide inserts  
 Portaghi con inserti al tungsteno - Portaagujas con plaquitas de carburo de tungsteno  
 Porte aiguilles avec plaquettes en carbure de tungstène

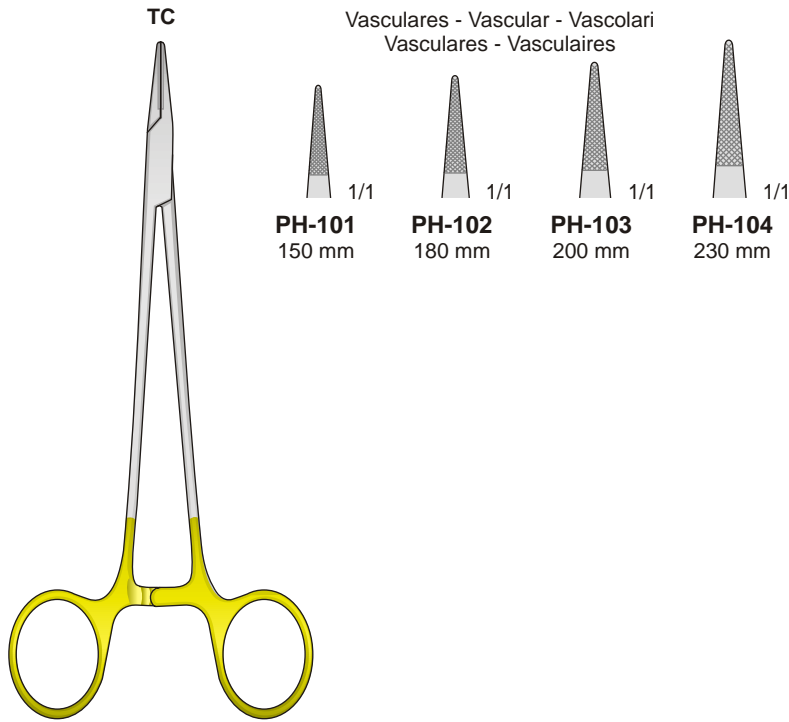

**MICRO-VASCULAR  
PH-101/PH-104**

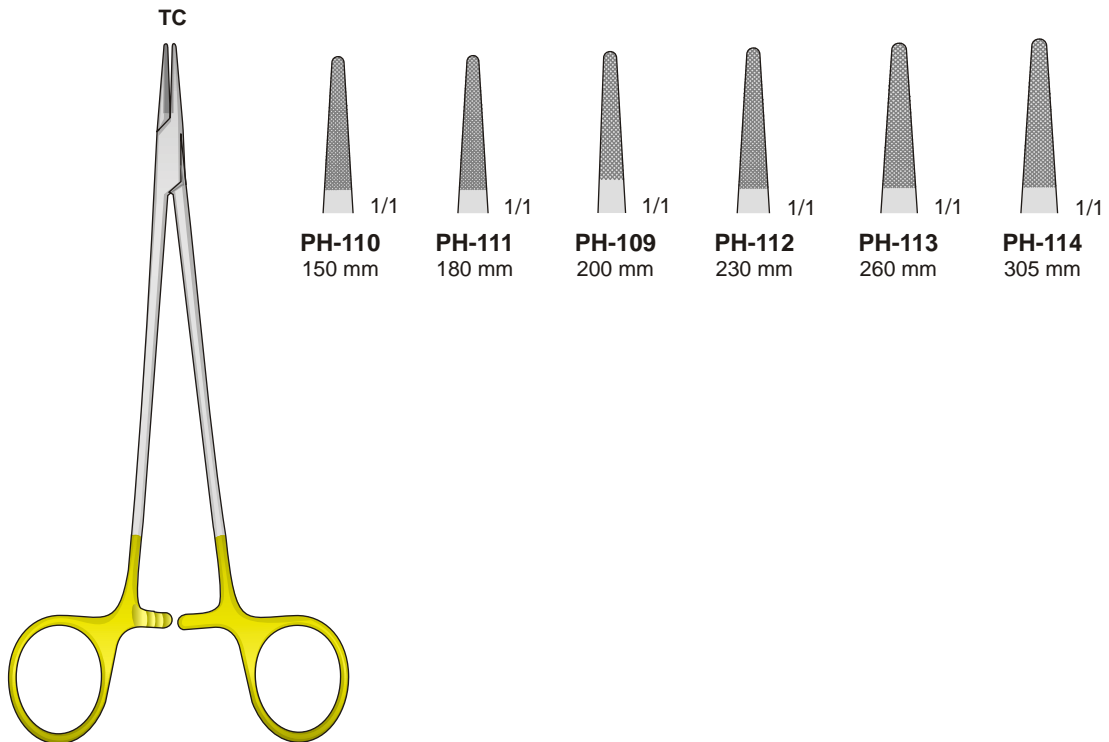

**DE BAKEY  
PH-109/PH-114**

Nadelhalter

Needle Holders

Port'aghi

Portaagujas

Porte aiguilles

Nadelhalter mit Hartmetalleinlagen - Needle Holders with tungsten-carbide inserts  
 Portaghi con inserti al tungsteno - Portaagujas con plaquitas de carburo de tungsteno  
 Porte aiguilles avec plaquettes en carbure de tungstène

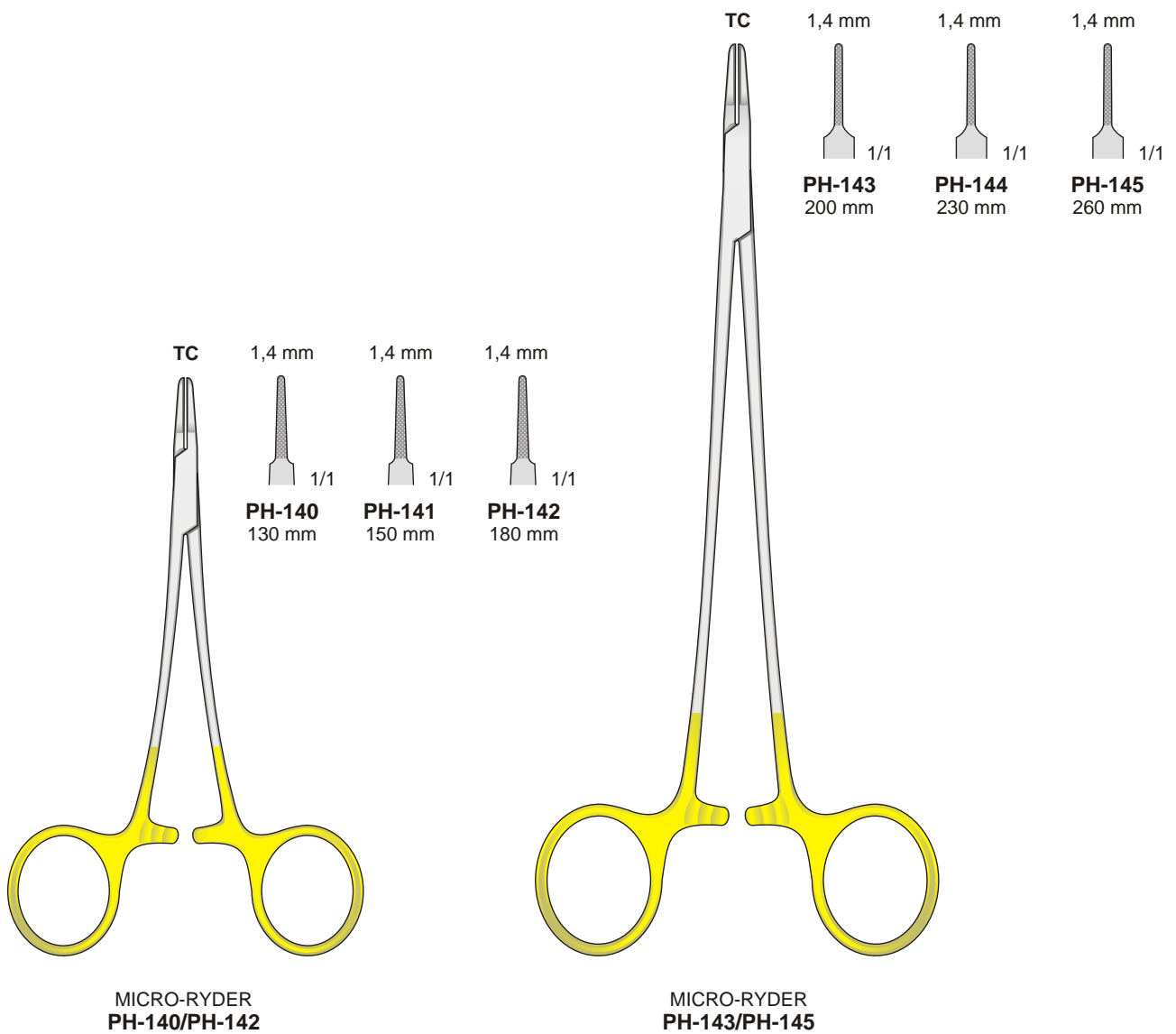

Nadelhalter mit Hartmetalleinlagen - Needle Holders with tungsten-carbide inserts  
 Portaghi con inserti al tungsteno - Portaagujas con plaquitas de carburo de tungsteno  
 Porte aiguilles avec plaquettes en carbure de tungstène

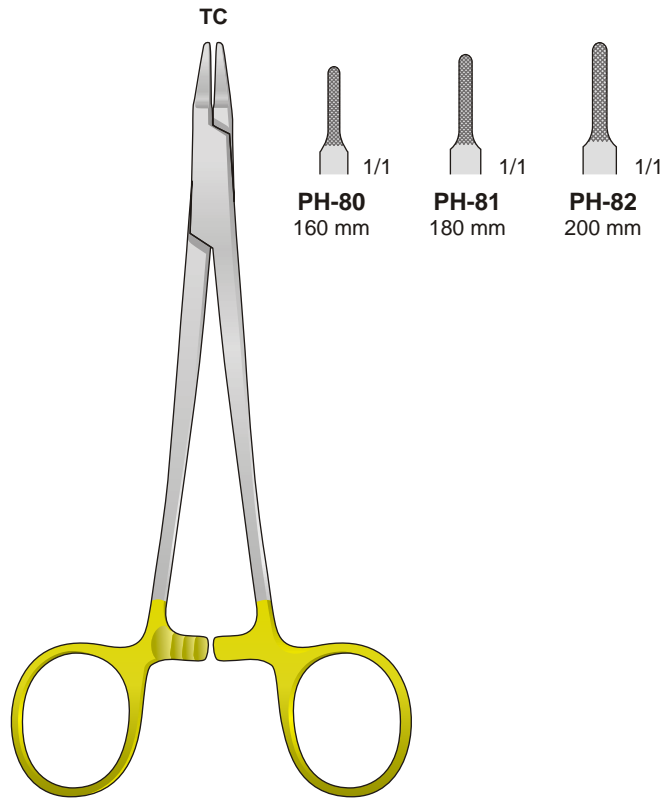

**RYDER**  
**PH-80/PH-82**

Ein Ring Abgewinkelt  
 One ring angled  
 Un anello angolato  
 Un anneau décalé

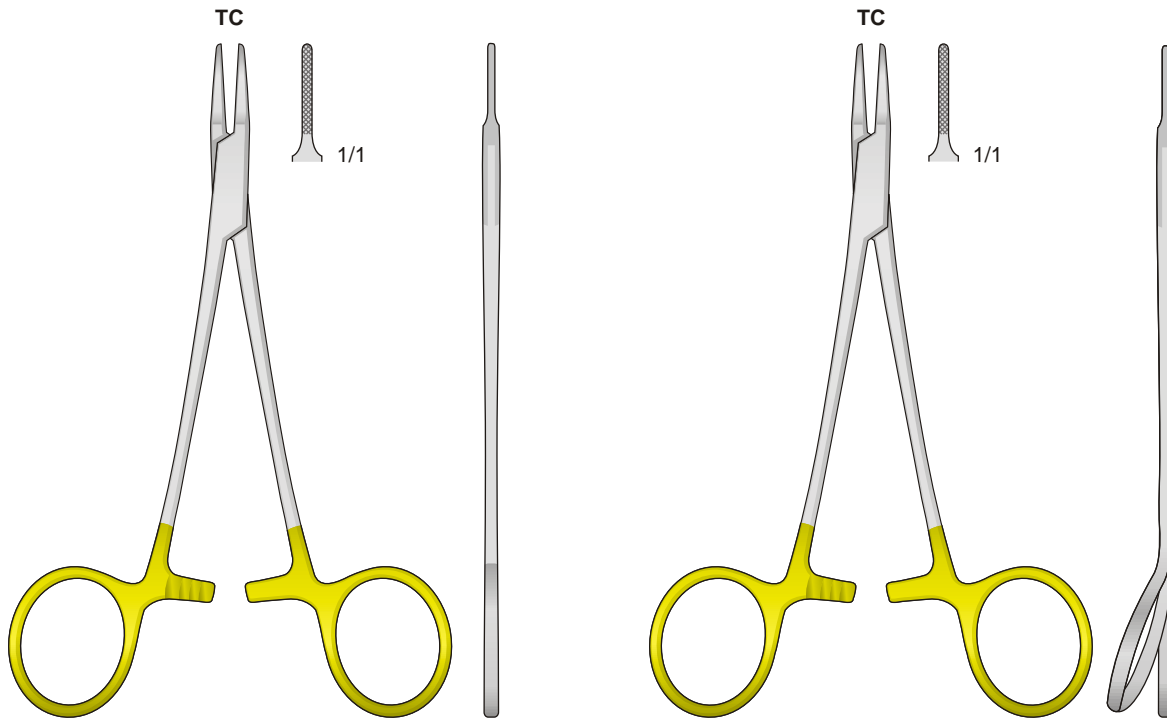

**MICRO-RYDER**  
**PH-83**  
140 mm

**PH-84**  
140 mm

Nadelhalter

Needle Holders

Port'aghi

Portaagujas

Porte aiguilles

Nadelhalter mit Hartmetalleinlagen - Needle Holders with tungsten-carbide inserts  
 Port'aghi con inserti al tungsteno - Portaagujas con plaquitas de carburo de tungsteno  
 Porte aiguilles avec plaquettes en carbure de tungstène

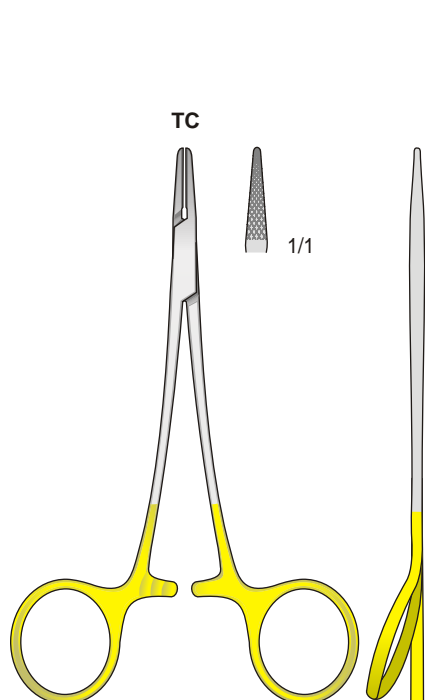

**PH-99**  
120 mm

Ein Ring abgewinkelt  
 One ring angled  
 Un anello angolato  
 Un anneau décalé

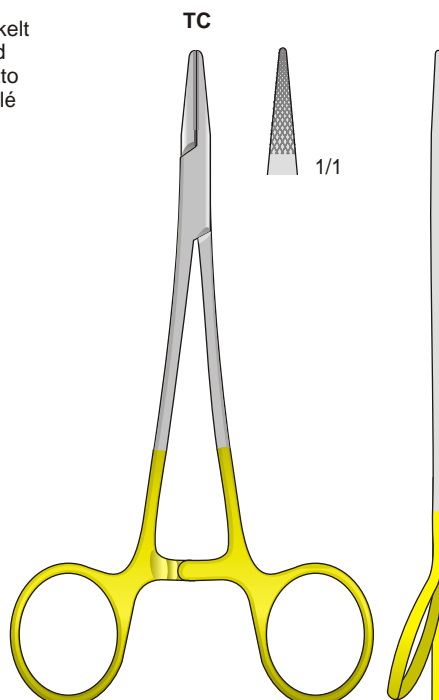

**CRILE-WOOD**  
**PH-100**  
150 mm

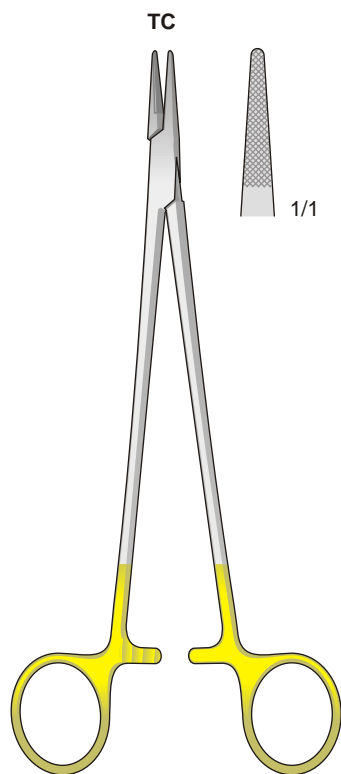

**HEGAR-MAYO-SEELEY**  
**PH-130**  
200 mm

Nadelhalter, Draht-Zangen - Needle holder, wire forceps  
 Port'aghi per fili d'acciaio - Porta agujas, pinzas para hilos  
 Porte-aiguilles, pinces à saisir

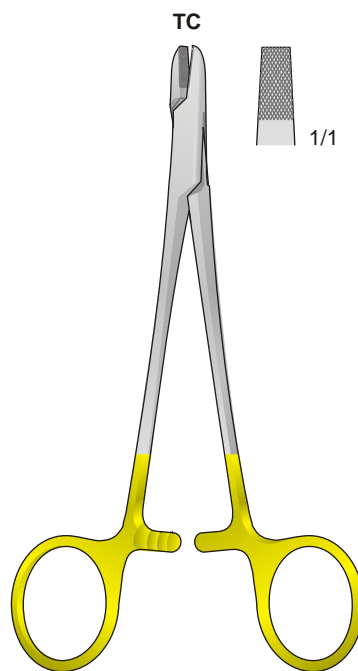

**PH-58**  
150 mm

Nadelhalter

Needle Holders

Port'aghi

Portaagujas

Porte aiguilles

Nadelhalter mit Hartmetalleinlagen - Needle Holders with tungsten-carbide inserts  
 Portaghi con inserti al tungsteno - Portaagujas con plaquitas de carburo de tungsteno  
 Porte aiguilles avec plaquettes en carbure de tungstène

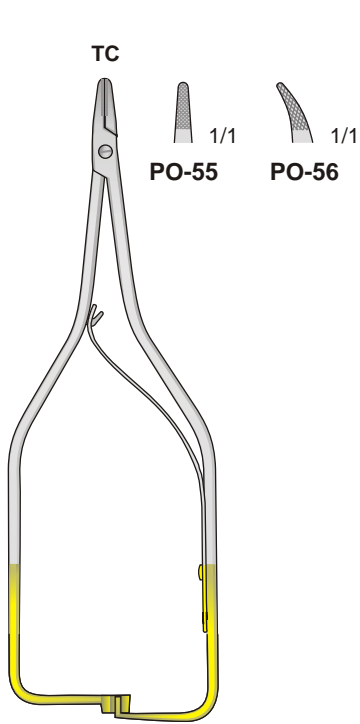

BOYNTON  
**PO-55/PO-56**  
 120 mm

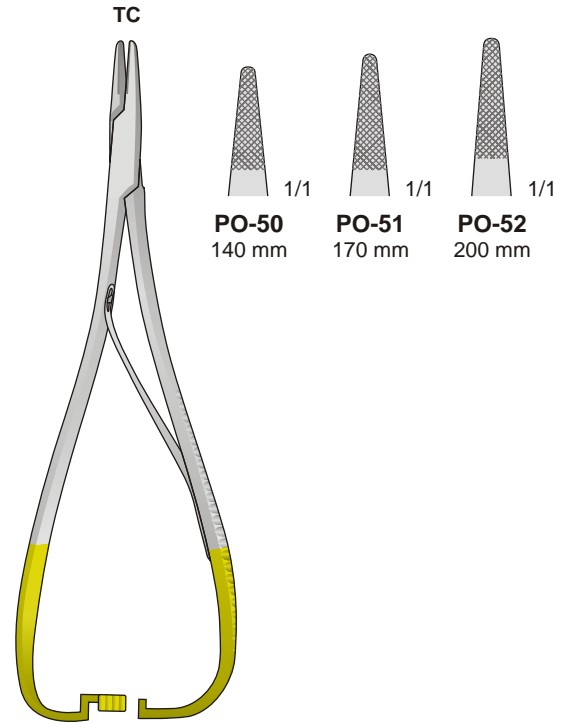

MATHIEU  
**PO-50/PO-52**

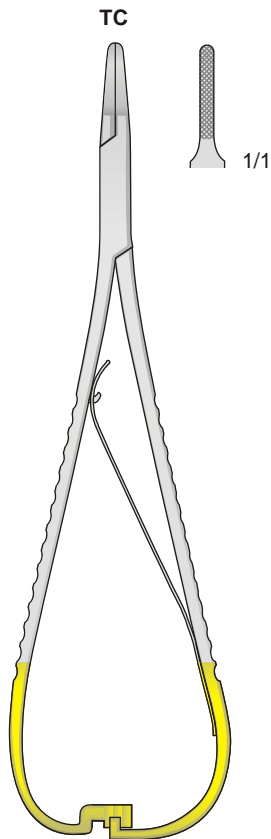

LICHTENBERG  
**PO-86**  
 175 mm

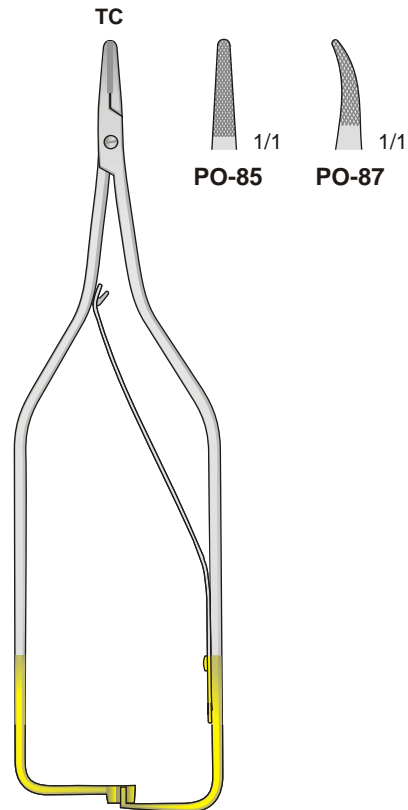

ARRUGA  
**PO-85/PO-87**  
 160 mm

Gefäßclips

Vessel Clips

Clamps vascolari

Clamps vasculaires

Clamps vasculares

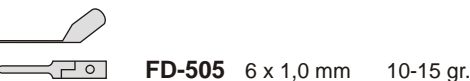
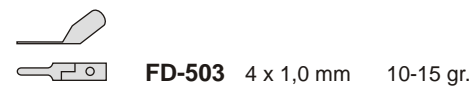
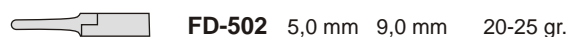
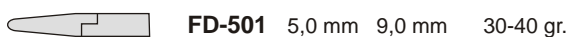
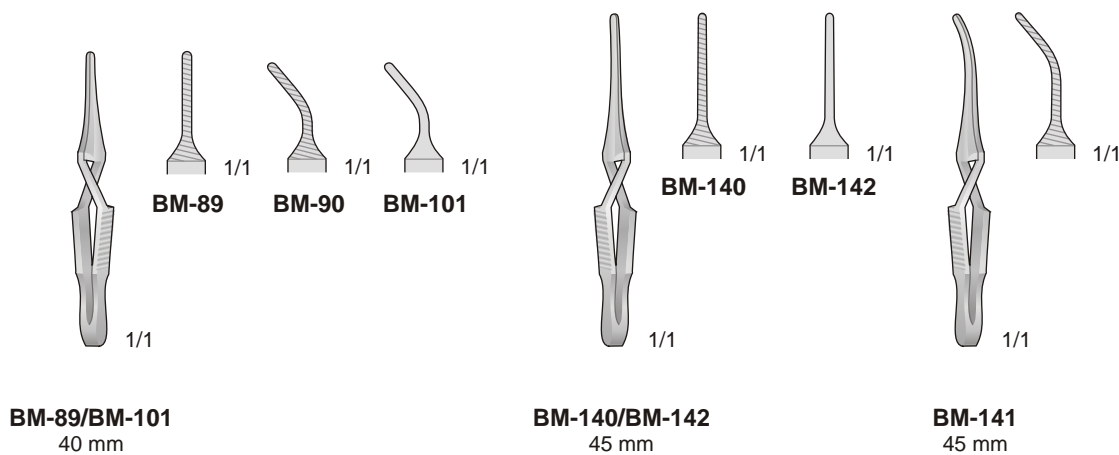
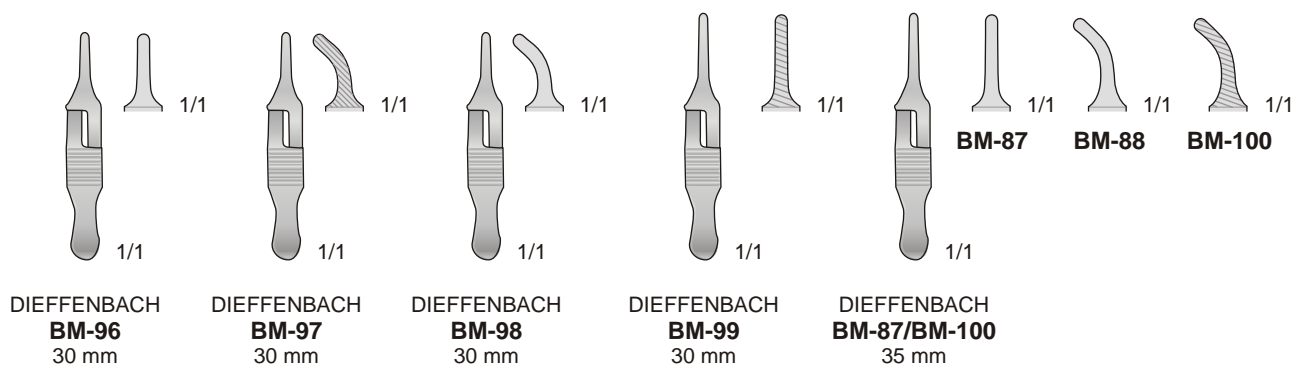

BIEMER  
FD-500/FD-502

MEDHORN  
FD-503/FD-506

Gefäßklemmen Acland

Vascular Clamps Acland

Clamps Acland Vascolari

Clamps vasculaires Acland

Clamps vasculares Acland

8 mm



Ø Gefäß / Vessel  
0,4 - 1,0 mm

Einzelklemmen  
Single Clamp



Vene - Vein  
Arterie - Artery

**FE-21**  
**FE-22**

Einzelklemmen  
Single Clamp



**FE-27**  
**FE-28**

Approximator  
Approximator



**FE-37**  
**FE-38**

Approximator  
Approximator



**FE-43**  
**FE-44**

Doppelklemmen  
Double Clamp



**FE-49**  
**FE-50**

11 mm

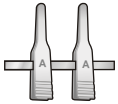

Ø Gefäß / Vessel  
0,6 - 1,5 mm



Vene - Vein  
Arterie - Artery

**FE-23**  
**FE-24**



**FE-29**  
**FE-30**

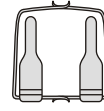

**FE-39**  
**FE-40**

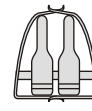

**FE-45**  
**FE-46**

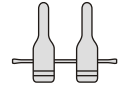

**FE-51**  
**FE-52**

17 mm

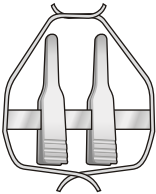

Ø Gefäß / Vessel  
1,0 - 2,25 mm



Vene - Vein  
Arterie - Artery

**FE-25**  
**FE-26**



**FE-31**  
**FE-32**

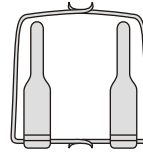

**FE-41**  
**FE-42**

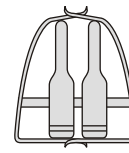

**FE-47**  
**FE-48**

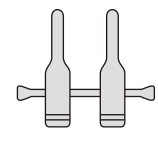

**FE-53**  
**FE-54**

25 mm



Ø Gefäß / Vessel  
1,5 - 3,5 mm



Vene - Vein  
Arterie - Artery

**FE-33**  
**FE-34**

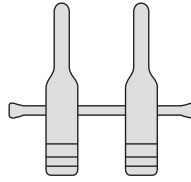

**FE-55**  
**FE-56**

Klemmen-Anlegepinzette  
Clamp Applying Forceps



36 mm



Ø Gefäß / Vessel  
2,0 - 5,0 mm



Vene - Vein  
Arterie - Artery

**FE-35**  
**FE-36**

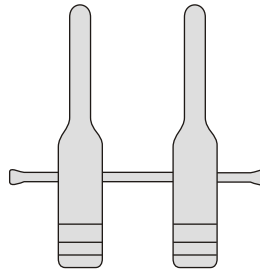

**FE-57**  
**FE-58**

**FE-59** mit Schloß, with lock  
**FE-60** ohne Schloß, without lock  
140 mm



Approximatoren

Approximators

Approssimatori

Approximateurs

Approximateores

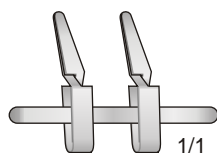

BIEMER-MÜLLER  
FD-507/FD-511

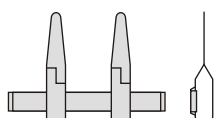

**FD-507** 5,0 mm 9,0 mm 25-30 gr.

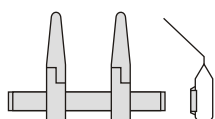

**FD-508** 5,0 mm 9,0 mm 25-30 gr.

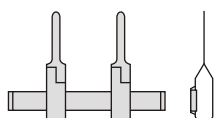

**FD-509** 5,0 mm 9,0 mm 25-30 gr.

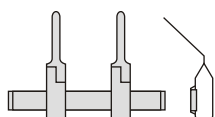

**FD-510** 5,0 mm 9,0 mm 25-30 gr.

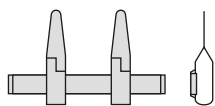

**FD-511** 3,5 mm 4,5 mm 25-30 gr.

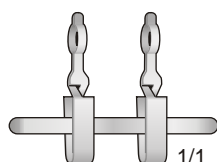

MÜLLER  
FD-512/FD-515

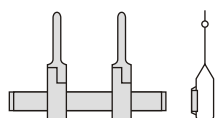

**FD-512** Ø 1,0 mm 25-30 gr.

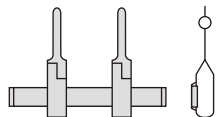

**FD-513** Ø 2,0 mm 25-30 gr.

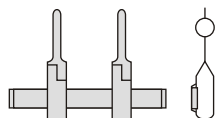

**FD-514** Ø 3,0 mm 25-30 gr.

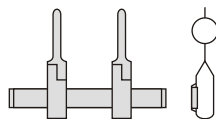

**FD-515** Ø 4,0 mm 25-30 gr.

Schlüssel  
Key - Chiave  
Llave - Clef

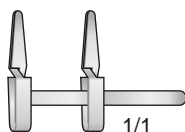

BIEMER  
FD-517

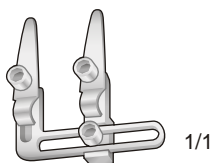

**FD-518**

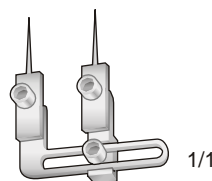

BIEMER  
FD-519

**FD-517**

Approximator allein  
Approximator only

**FD-518**

Approximator mit Schlüssel  
Approximator with key

**FD-519**

Approximator mit Schlüssel  
Approximator with key

**FD-520**

1 Paar Ersatznadeln  
1 Pair of spare needles

Mikro-Löffelzängchen  
Micro cup shaped forceps  
Micro pinza a cucchiaio  
Micro pinza con boca en forma de cucharilla  
Pince à cuillère

0,9 x 1,0 mm



**DB-86**

Mikro-Scheren  
Micro scissors  
Micro forbici  
Micro Tijeras  
Micro Ciseaux



**BELLUCCI  
DB-106**

1,0 mm



**WULLSTEIN  
DB-91**



**DB-93**

0,9 x 1,1 mm



**DB-205**

4,0 x 0,5 mm



Maulteille Gerieft  
Serrated Jaws  
Morsi zigrinati  
Boca estriada  
Mors striés

**DB-215**

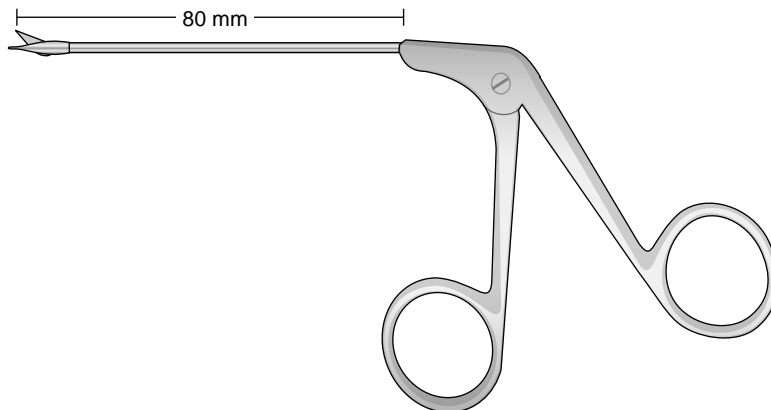

**DB-86/DB-215  
80 mm**

Unterbindungsnadeln

Ligature needles

Aghi per legature

Agujas para ligaduras

Aiguilles à ligatures

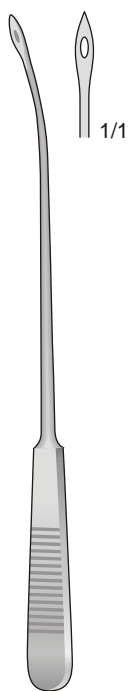

OBWEGESER  
**DO-30**  
140 mm

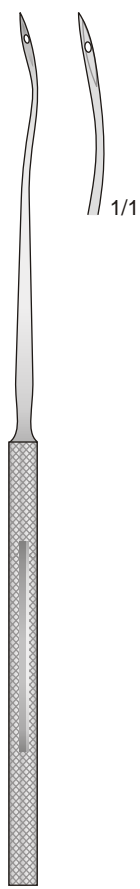

YANKAUER  
**BM-151**  
170 mm

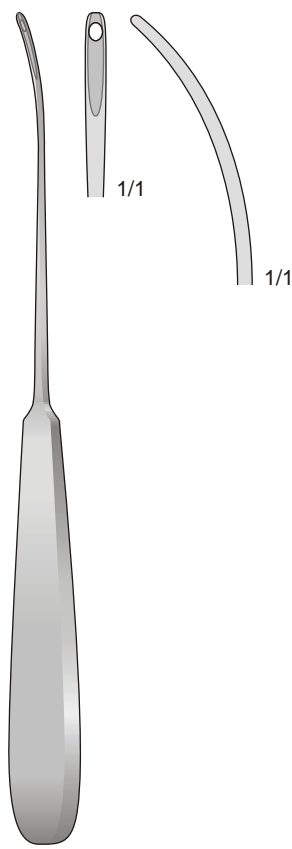

**BM-28**  
200 mm

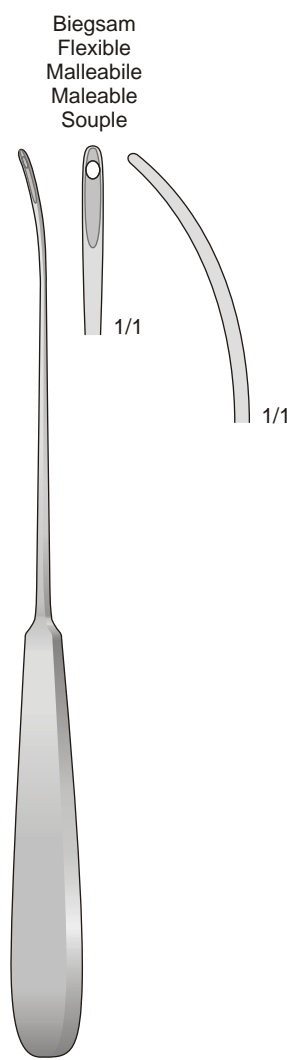

**BM-74**  
230 mm

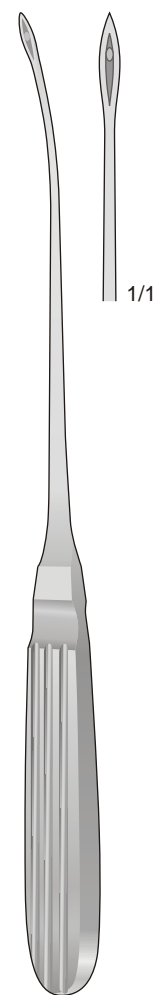

OBWEGESER  
**DO-31**  
230 mm

Sonden

Probes

Sonde bottonute

Estiletos

Sondes

Ø 1 mm



Ø 1,5 mm



Ø 2 mm



Ø 2 mm



Ø 1,5 mm

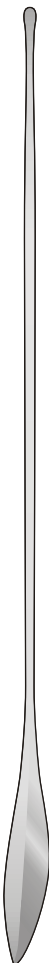

Ø 1,0 mm



Aus Silber  
Sterling Silver  
In argento  
De plata en argent



**PF-20** 145 mm  
**PF-21** 160 mm

**PF-32** 130 mm  
**PF-22** 145 mm  
**PF-25** 160 mm  
**PF-26** 200 mm

**PF-27** 145 mm  
**PF-23** 160 mm  
**PF-28** 200 mm  
**PF-44** 250 mm

**PF-36** 130 mm  
**PF-15** 145 mm  
**PF-29** 160 mm  
**PF-38** 200 mm

**PF-7**  
145 mm

STACKE  
**PF-14**  
110 mm

BOWMANN  
**PF-30** 00/0  
**PF-31** 01/2  
**PF-33** 03/4  
**PF-34** 05/6  
**PF-35** 07/8  
**PF-37** 06/7

Watteträger

Cotton applicators

Porta cotone

Portaalgodòn

Porte cotons

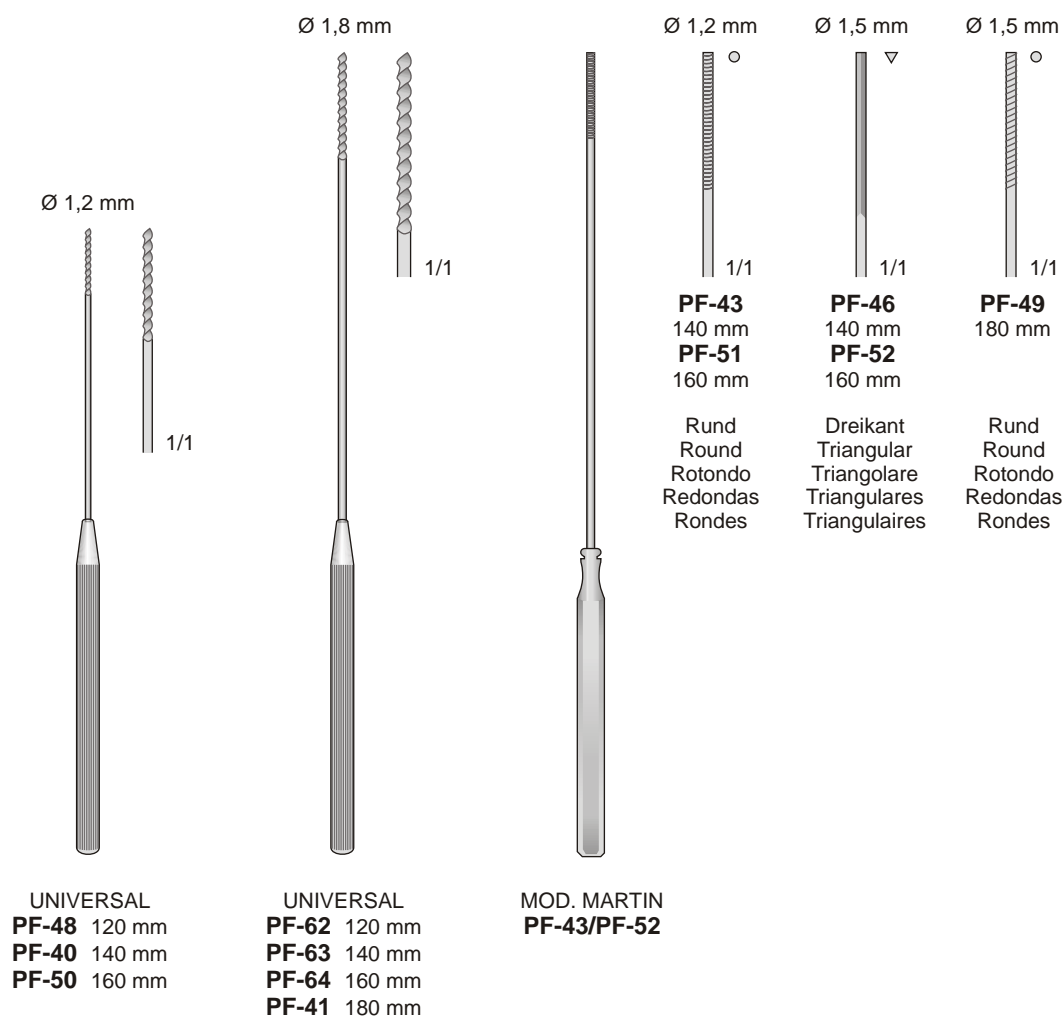





SADIQ SURGICAL CO.

Catalogue 2015 / 2016



6

Mundsperrer, Wundhaken, Nasen Spekula  
Mouth gags, Retractors, Nasal Specula  
Apribocca, Divaricatori, Speculum nasali  
Aprebocas, Separadores, Espéculos nasales  
Ecarteur buccal, Ecarteurs, Spéculums nasaux





Mundsperrer

Mouth gags

Apribocca

Abrebocas

Ecarteur buccal

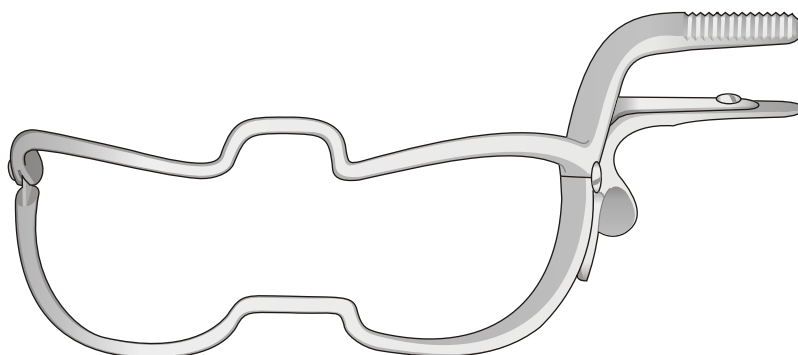

WHITEHEAD-JENNINGS

- OM-136** 90 mm
- OM-137** 110 mm
- OM-138** 130 mm
- OM-139** 150 mm

KILNER-DOUGHTY

**OM-160**

Komplett mit 3 Zungenspatel  
 Complete with 3 tongue depressors  
 Completo con 3 abbassalingua  
 Completo con 3 abaja lengua  
 Complet avec 3 abaisse-langues

Sperrer allein  
 Gag only  
 Apribocca solo  
 Apre-boca suelto  
 Manche et cadreseuls

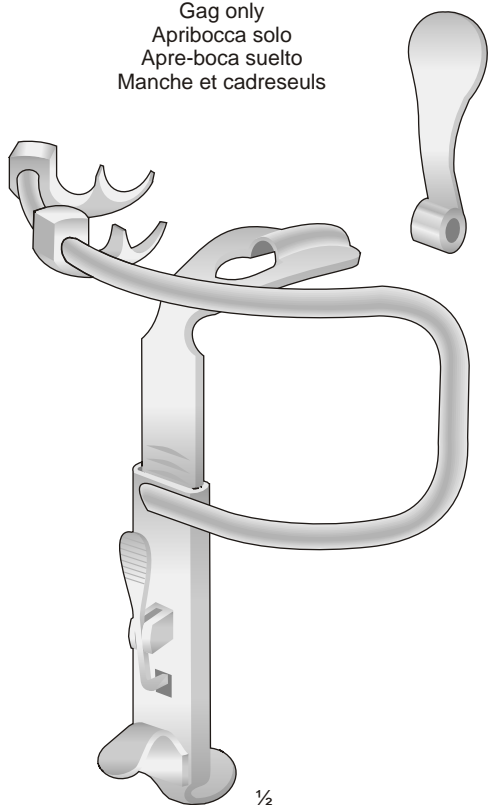

KILNER-DOUGHTY  
**OM-161**

Fig. 1

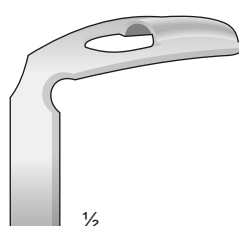

**OM-162**  
 28 x 65 mm

Fig. 2

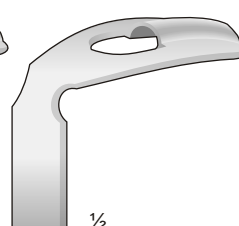

**OM-163**  
 32 x 75 mm

Fig. 3

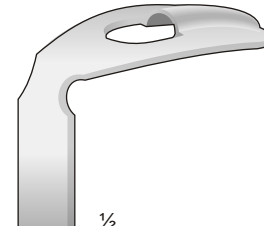

**OM-164**  
 37 x 80 mm

Mundsperrer

Mouth gags

Apribocca

Abrebocas

Ecarteur buccal

Sperrer allein  
Gag only  
Apribocca solo  
Apre-boca suelto  
Manche et cadreseuls

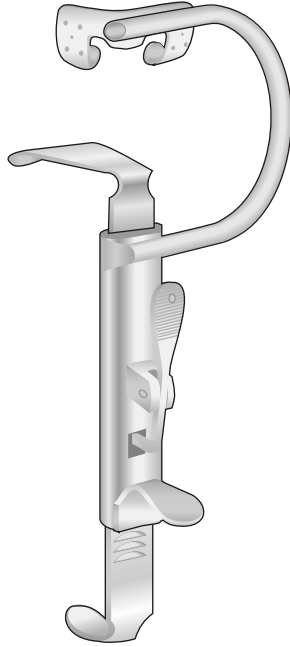

**DAVIS-BOYLE  
OM-141**

**DAVIS-BOYLE  
OM-140**  
Komplett mit 5 Zungenspatel  
Complete with 5 tongue depressors  
Completo con 5 abbassalingua  
Completo con 5 abaja lengua  
Complet avec 5 abaisse-langues

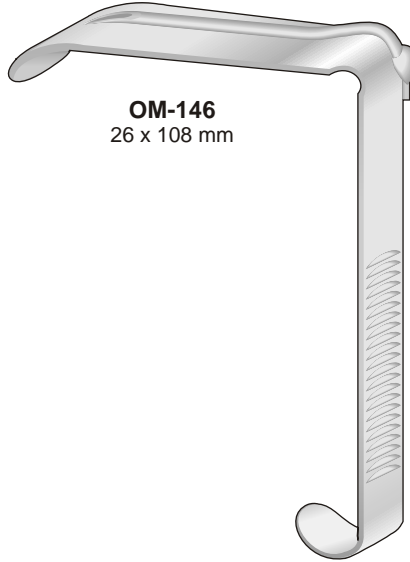

**OM-146  
26 x 108 mm**



**OM-145  
25 x 93 mm**

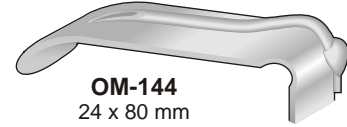

**OM-144  
24 x 80 mm**

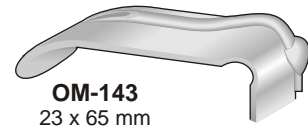

**OM-143  
23 x 65 mm**

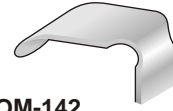

**OM-142  
21 x 30 mm**

**Mc-IVOR  
OM-170**  
Komplett mit 3 Zungenspatel  
Complete with 3 tongue depressors  
Completo di 3 abbassalingua  
Completo con 3 abaja lengua  
Complet avec 3 abaisse-langues

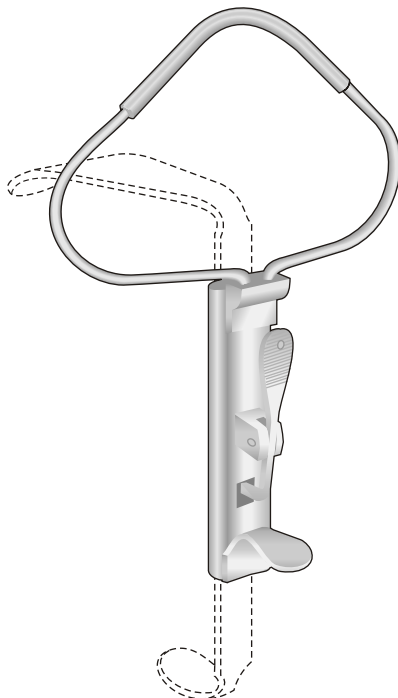

**Mc-IVOR  
OM-171**



**OM-174  
26 x 100 mm**

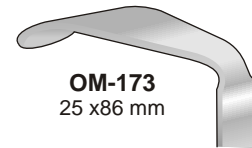

**OM-173  
25 x 86 mm**

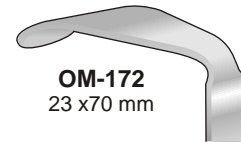

**OM-172  
23 x 70 mm**

Mundsperrer

Mouth gags

Apribocca

Abrebocas

Ecarteur buccal

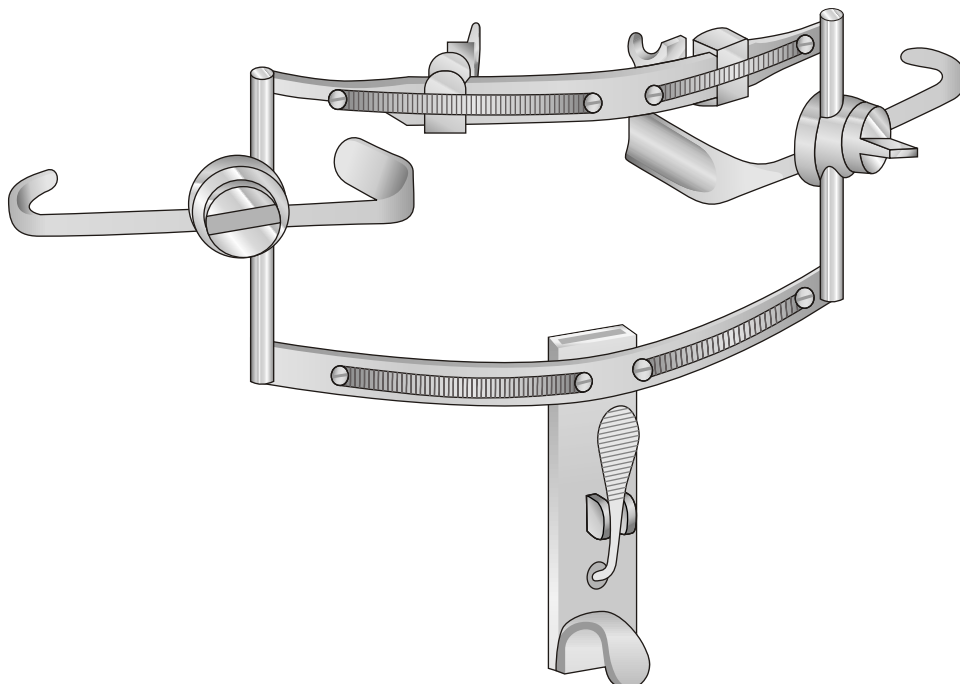

**DINGMANN  
OM-111**

Zungenspatel  
Tongue depressor  
Abbassalingua  
Bajalengua  
Abaisse langue

Fig. 1

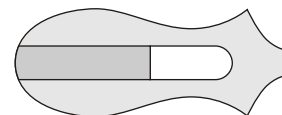

**OM-112**  
65 x 25 mm

Fig. 2

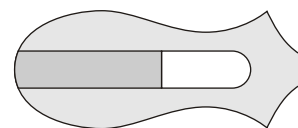

**OM-113**  
70 x 29 mm

Fig. 3

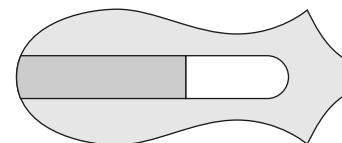

**OM-114**  
80 x 32 mm

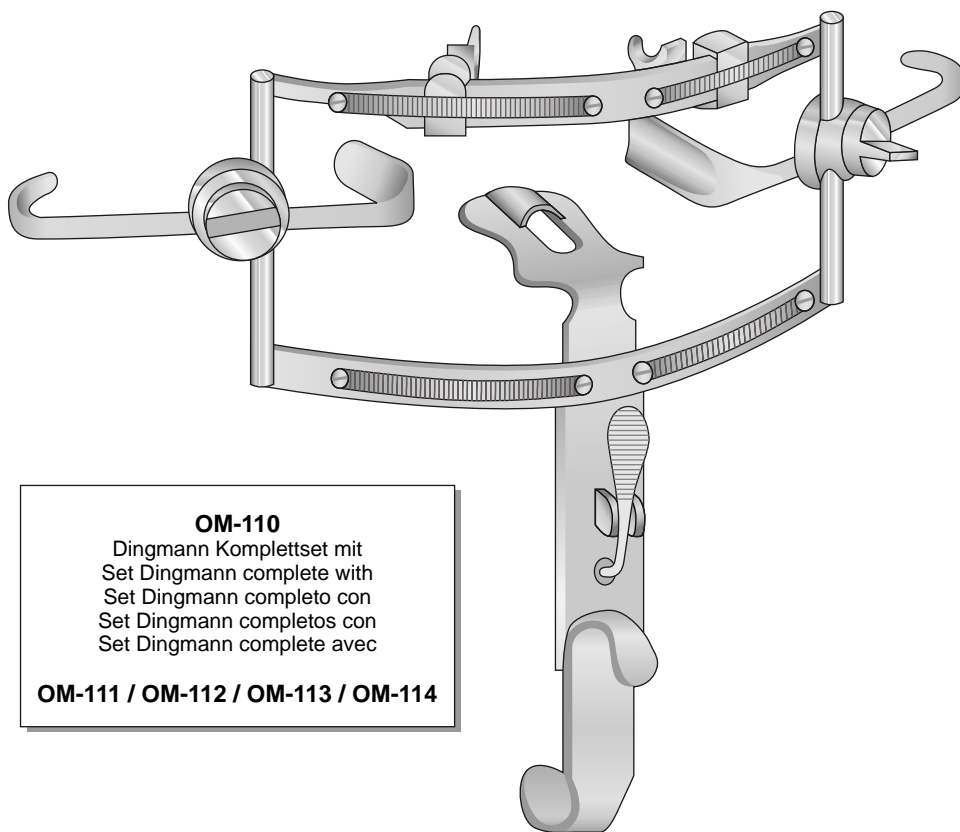

**OM-110**  
Dingmann Komplettsset mit  
Set Dingmann complete with  
Set Dingmann completo con  
Set Dingmann completos con  
Set Dingmann complete avec  
**OM-111 / OM-112 / OM-113 / OM-114**

**DINGMANN  
OM-110**  
Set completo

Wundhaken

Retractors

Divaricatori

Separadores

Ecarteurs

**OM-85**  
 Komplettsset mit 3 Spatel  
 Set complete with 3 spatulas  
 Set completo con 3 spatole  
 Set completos con 3 espátulas  
 Set complete avec 3 spatules  
**OM-80 + OM-81 + OM-82**

Biegsam - Malleable  
 Malleabile - Maleable - Souple



**OM-101** 30 mm  
**OM-102** 40 mm  
**OM-103** 50 mm  
 330 mm

Biegsam - Malleable  
 Malleabile - Maleable - Souple

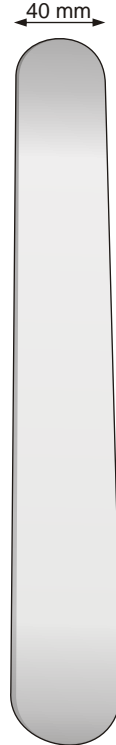

40 mm  
 50 mm  
 HABERER  
**OM-104**  
 300 mm

Biegsam - Malleable  
 Malleabile - Maleable - Souple

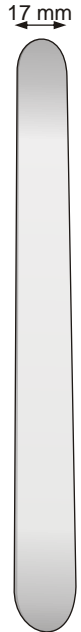

17 mm  
 25 mm  
 TUFFIER  
**OM-99**  
 200 mm

Rostfrei - Stainless Steel - Acciaio - Acero - Acer  
 Biegsam - Malleable - Malleabili - Maleables - Souples

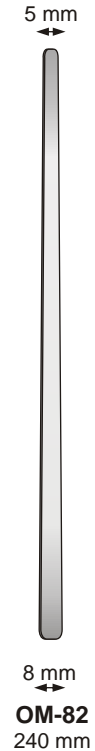
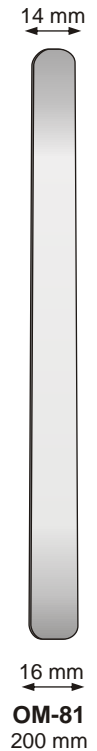
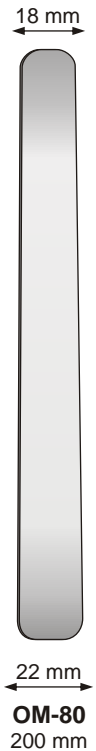

Rostfrei - Stainless Steel - Acciaio - Acero - Acer  
 Biegsam - Malleable - Malleabili - Maleables - Souples

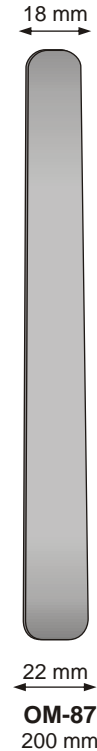

Schwarz Verchromt  
 Black anodized  
 Cromato nero  
 Cromado en negro  
 Chromé noir

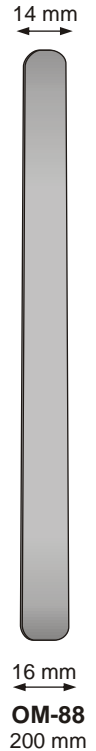

Zungendrucker

Tongue depressor

Abbassalingua

Bejalenguas

Abaisse-langues

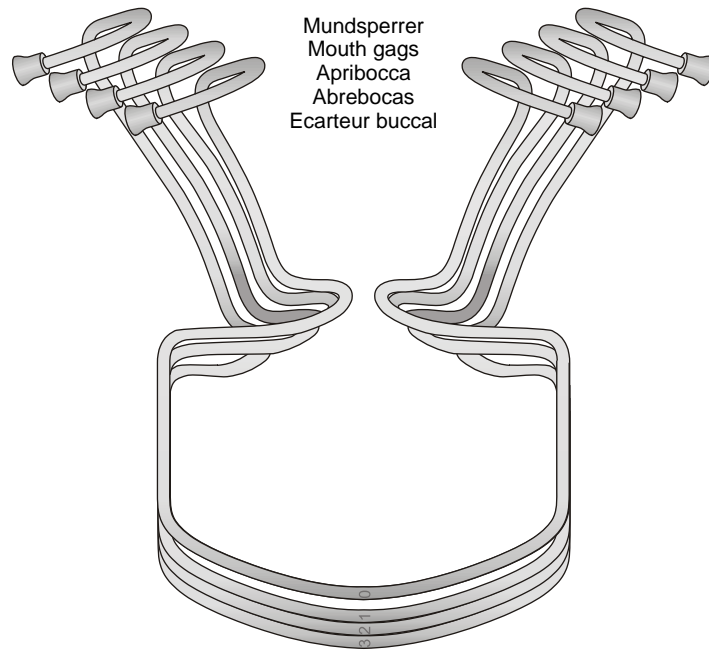

Mundsperrer  
Mouth gags  
Aprobocca  
Abrebocas  
Ecarteur buccal

ORINGER

- |              |        |              |             |
|--------------|--------|--------------|-------------|
| <b>OM-74</b> | Fig. 0 | 100 x 95 mm  | Per bambini |
| <b>OM-75</b> | Fig. 1 | 115 x 105 mm | Per adulti  |
| <b>OM-76</b> | Fig. 2 | 115 x 110 mm | Per adulti  |
| <b>OM-77</b> | Fig. 3 | 125 x 115 mm | Per adulti  |

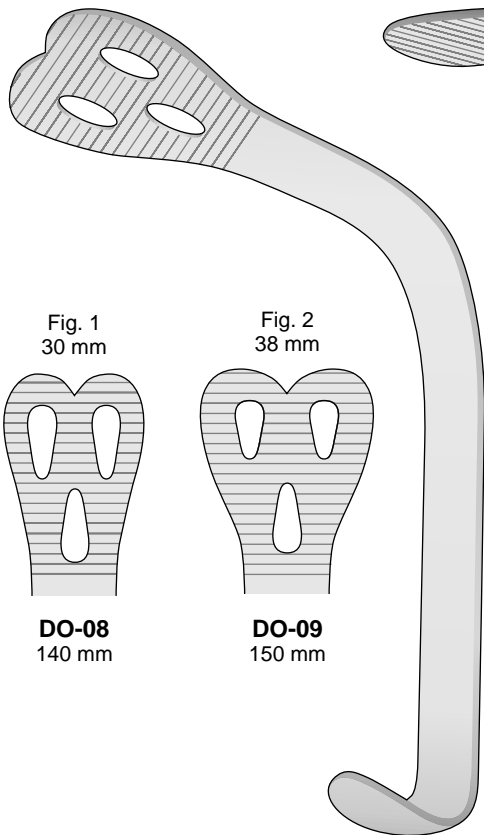

Fig. 1  
30 mm

Fig. 2  
38 mm

**DO-08**  
140 mm

**DO-09**  
150 mm

WIEDER  
**DO-08/DO-09**

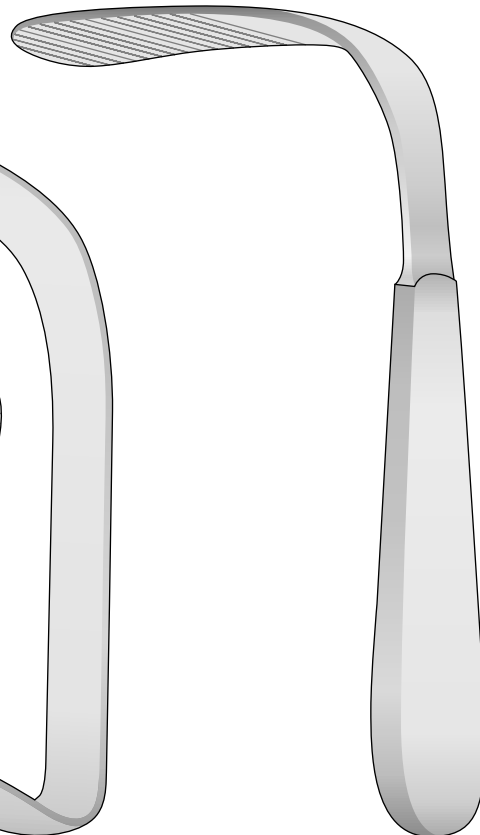

TOBOLD  
**OM-08**  
145 mm

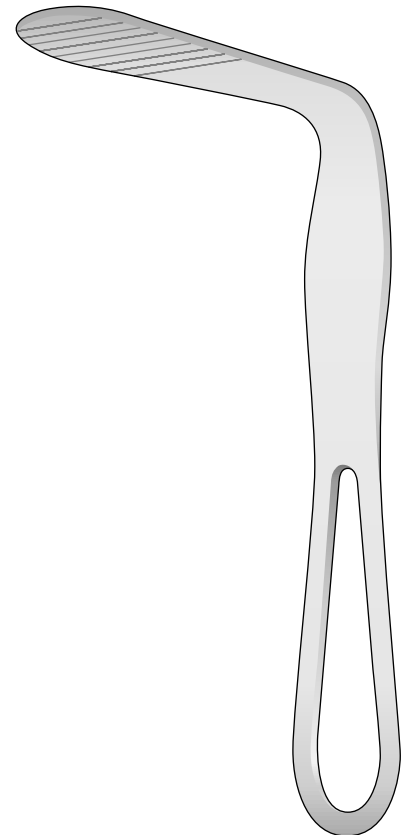

HARTMANN  
**OM-06**  
150 mm

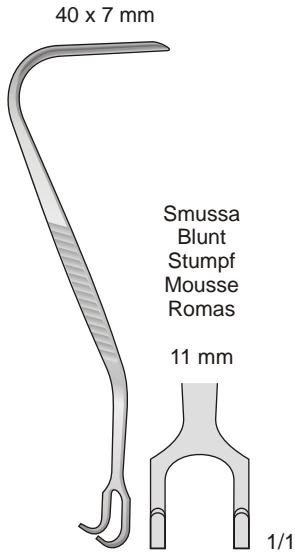

**AUFRICHT  
BT-381**  
135 mm

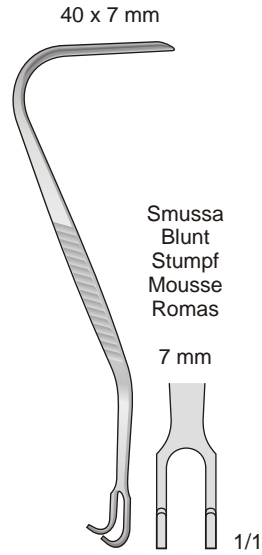

**AUFRICHT-WALTER  
BT-387**  
135 mm

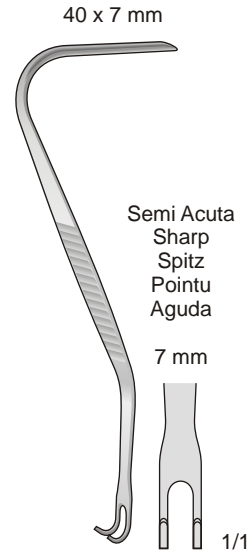

**AUFRICHT-WALTER  
BT-388**  
135 mm

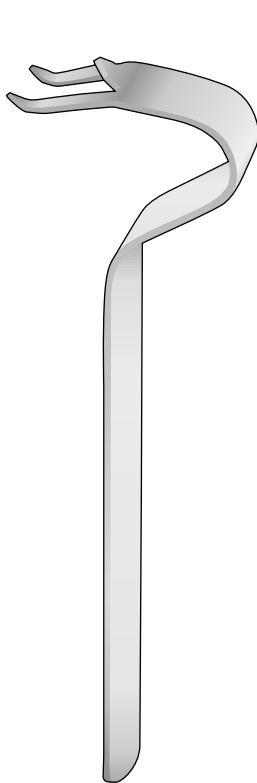

**OBWEGESER  
DO-40**  
155 mm

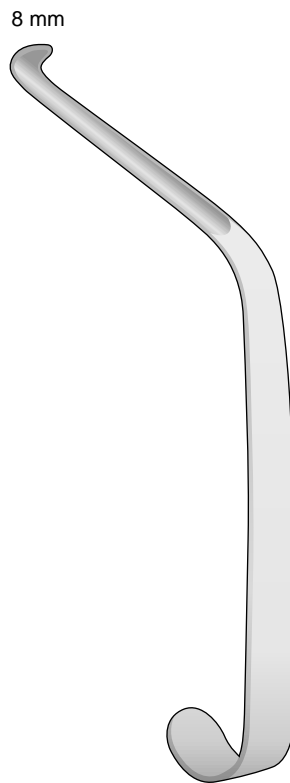

**OBWEGESER  
DO-41**  
165 mm

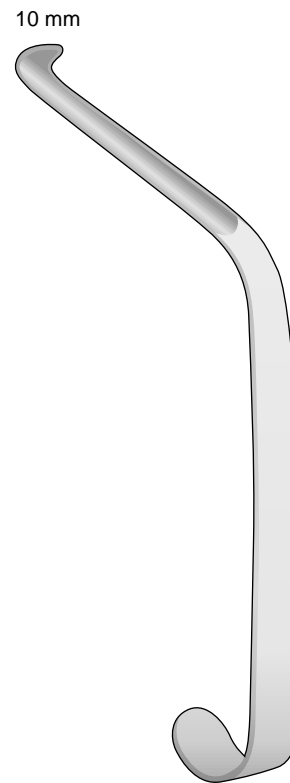

**OBWEGESER  
DO-142**  
165 mm

Wundhaken

Retractors

Divaricatori

Separadores

Ecarteurs

Posteriore  
Posterior

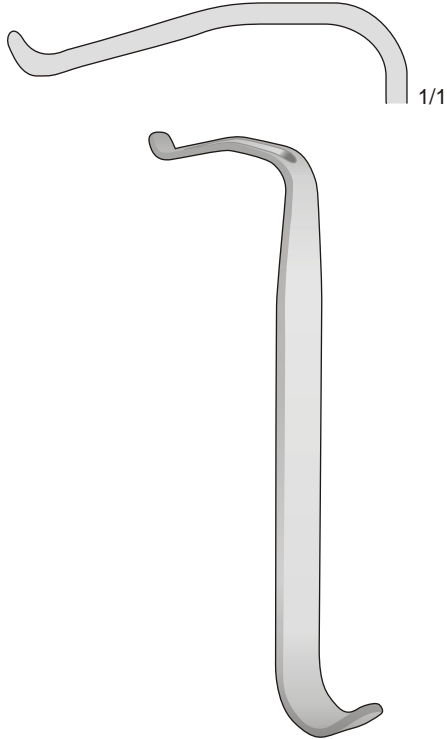

DUNN-DAUTREY  
**DO-94** 6,5 x 50 mm  
140 mm

Anterior  
Anteriore

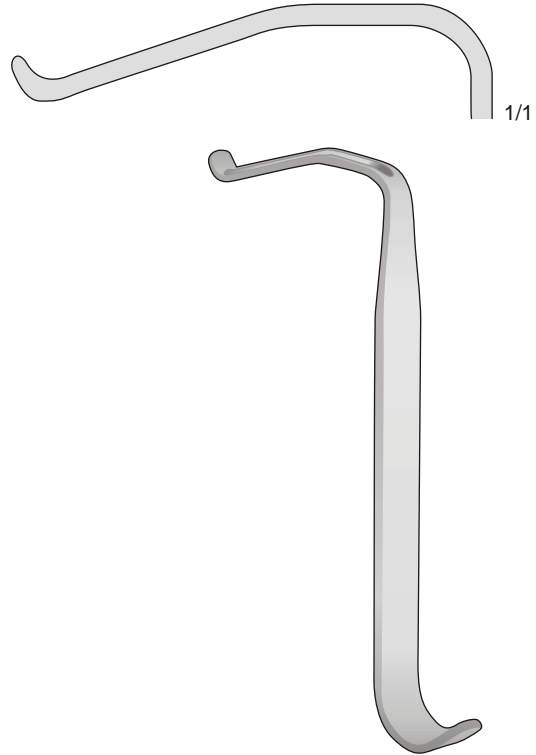

DUNN-DAUTREY  
**DO-95** 6,5 x 60 mm  
140 mm

Superior  
Superiore

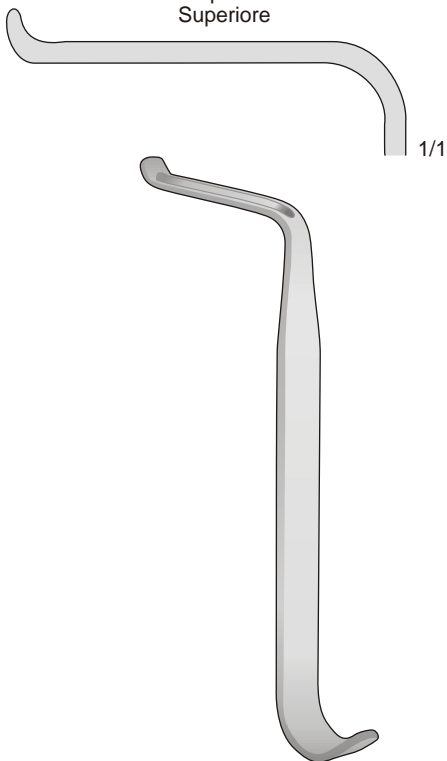

DUNN-DAUTREY  
**DO-96** 8 x 50 mm  
140 mm

Superior  
Superiore

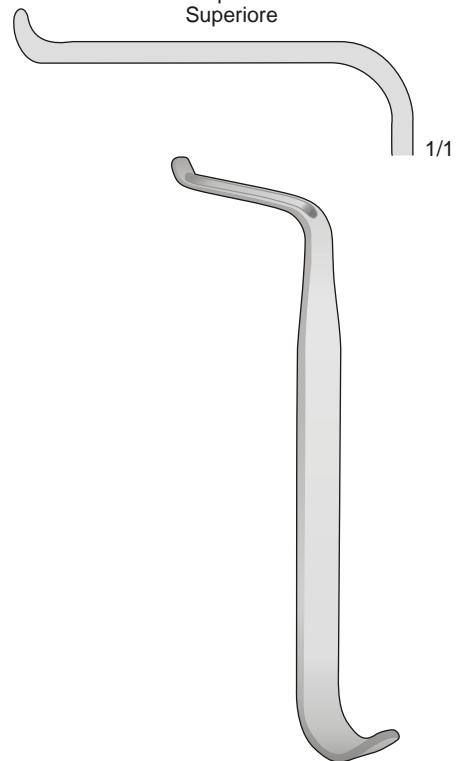

DUNN-DAUTREY  
**DO-97** 6,5 x 50 mm  
140 mm

Wundhaken

Retractors

Divaricatori

Separadores

Ecarteurs

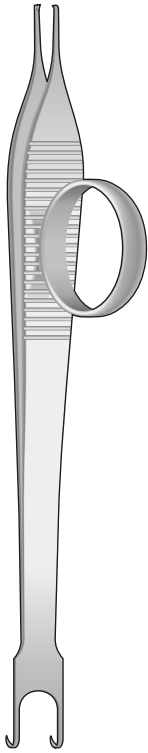

**MILLARD**  
**BD-342/BD-343**  
150 mm

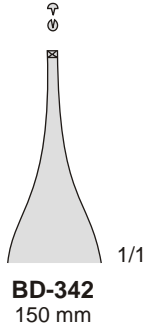

**BD-342**  
150 mm

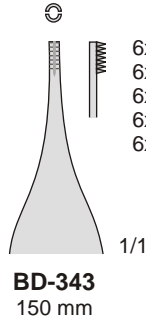

**BD-343**  
150 mm

6x6 Zähne  
6x6 Teeth  
6x6 Denti  
6x6 Dientes  
6x6 Dents

Fingerring Häkchen  
Finger ring Retractor  
Uncino nasale a forma di anello  
Ganchito en forma de anillo  
Crochet nasal en forme de bague

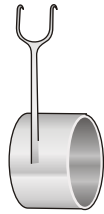

**COTTLE**  
**DO-259**

Knorpelquetsche  
Cartilage crusher  
Strumento per cartilagine  
Machacadora  
Pincas-Gouge à cartilage

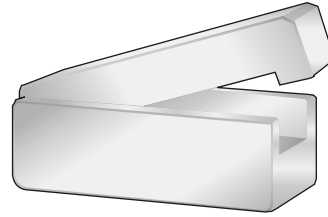

**COTTLE**  
**DO-264**

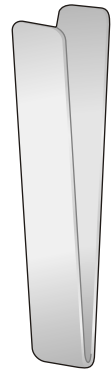

Nasenflügelhäkchen  
Alar Retractor  
Uncino per alette nasali  
Ganchos para las alas de la nariz  
Crochet pour les alles du nez

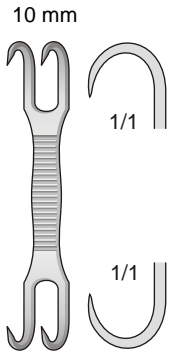

**BT-226**  
63 mm

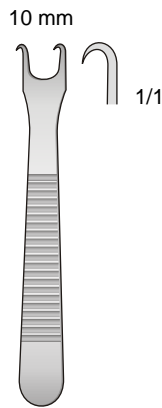

**KILNER**  
**BT-273**  
80 mm

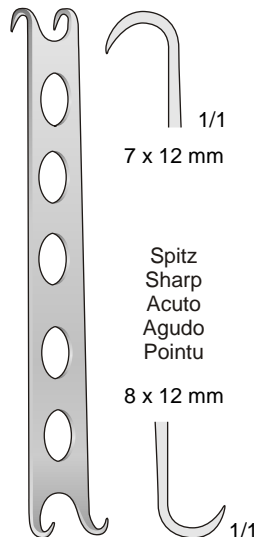

**CONVERSE**  
**BT-22**  
120 mm

Spitz  
Sharp  
Acuto  
Agudo  
Pointu



1/1  
7 x 12 mm

Spitz  
Sharp  
Acuto  
Agudo  
Pointu

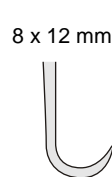

1/1  
8 x 12 mm



**COTTLE**  
**BT-196**  
160 mm



**COTTLE**  
**BT-197/BT-199**  
150 mm

Fig. 1 1/1  
Fig. 2 1/1  
Fig. 3 1/1  
**BT-197** **BT-198** **BT-199**



Mikro Wundhaken

Micro Retractors

Micro divaricatori

Micro Separadores

Micro Ecarteurs

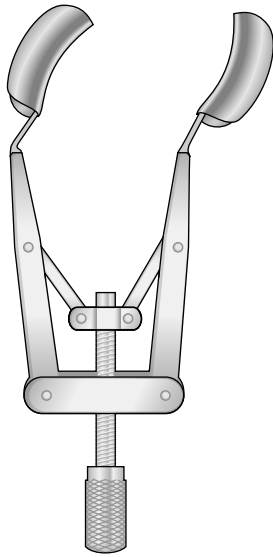

**KERSHNER  
NK-420**

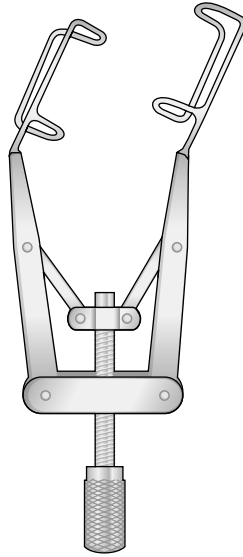

**KERSHNER  
NK-421**

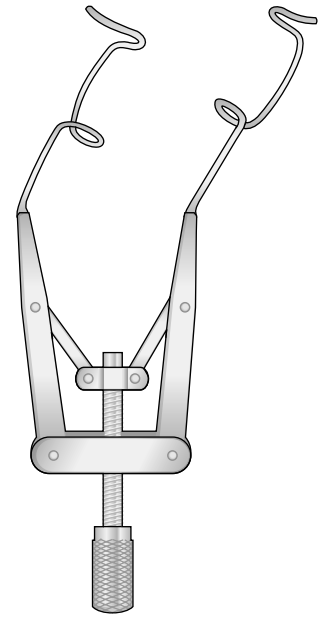

**LIEBERMANN-TENNANT  
NK-422**

Hauthäkchen - Cutaneous hook - Uncini cutanei - Ganchos cutáneos - Erignes cutanées

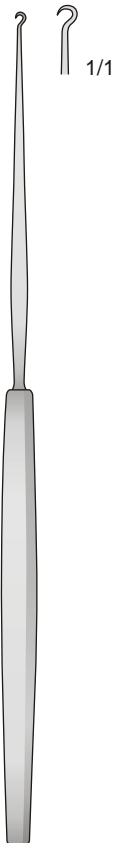

**GILLIES  
BT-15  
180 mm**

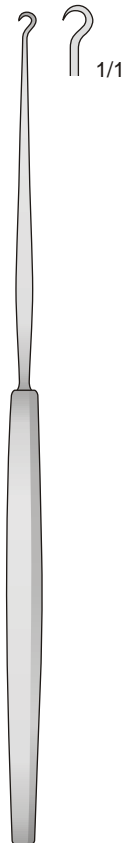

**GILLIES  
BT-16  
180 mm**

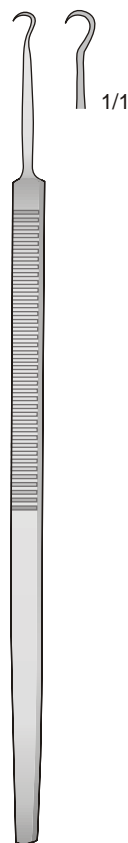

**BT-207  
160 mm**

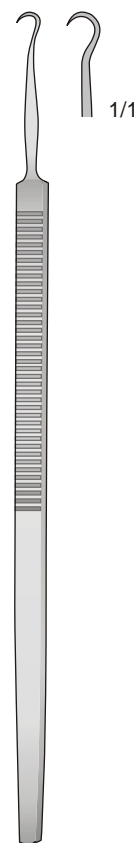

**BT-208  
160 mm**

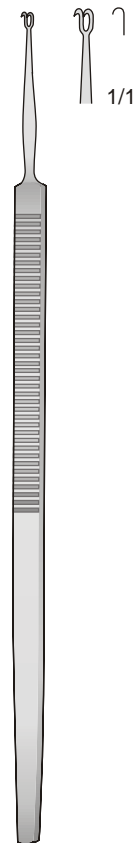

**GUTHRIE  
BT-203  
160 mm**

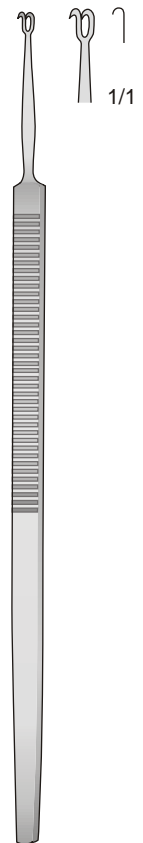

**GUTHRIE  
BT-204  
160 mm**

Sperrelevatoren - Eye specula - Blefarostati  
Blefarostatos - Blèpharostats

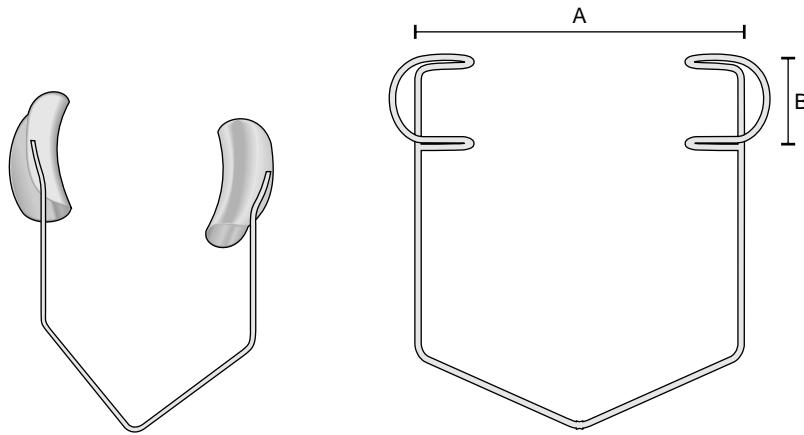

**BARRAQUER  
NK-83**

	A	B
<b>NK-80</b>	27 mm	5 mm
<b>NK-82</b>	34 mm	9 mm
<b>NK-84</b>	42 mm	12 mm
<b>NK-86</b>	42 mm	14 mm

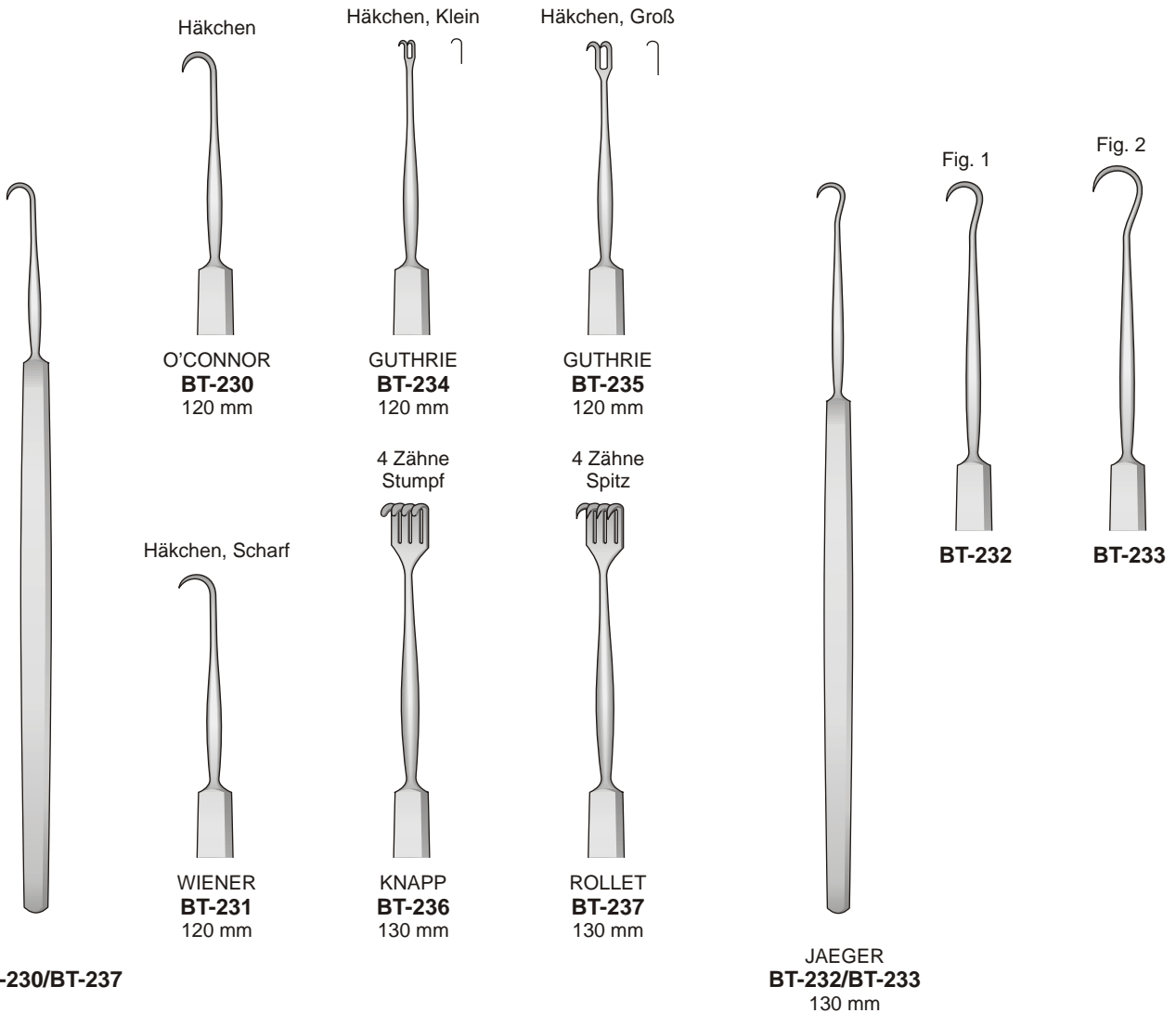

**BT-230/BT-237**

**JAEGER  
BT-232/BT-233  
130 mm**

Wundhaken

Retractors

Divaricatori

Separadores

Ecarteurs

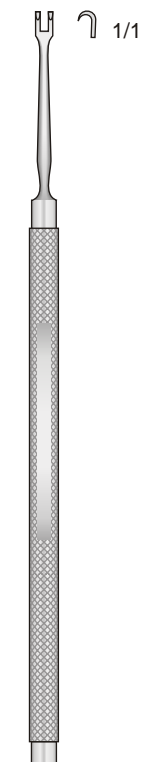

KIRBY  
BT-243  
130 mm

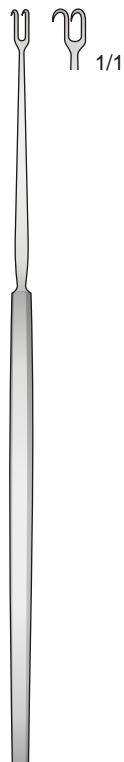

FREER  
BT-200  
150 mm

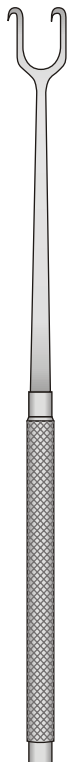

JOSEPH  
BT-210/BT-214  
160 mm

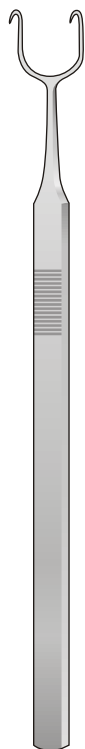
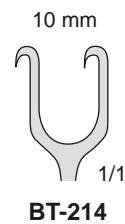
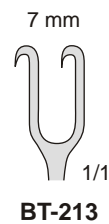
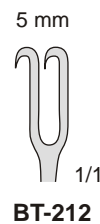
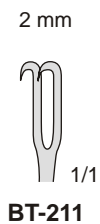

COTTLE  
BT-215/BT-217  
150 mm

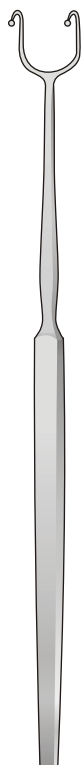
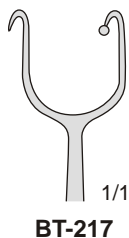
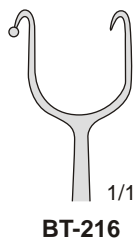
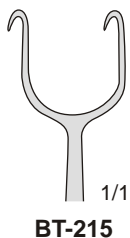

FOMON  
BT-218  
160 mm

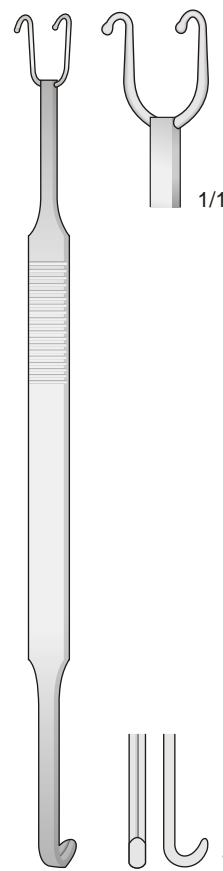
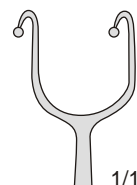

COTTLE-NEIVERT  
BT-57  
200 mm

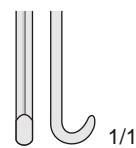
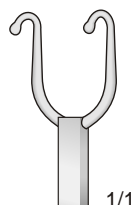

Wundhaken

Retractors

Divaricatori

Separadores

Ecarteurs

2 Zähne



3 Zähne



Häkchen



AXENFELD  
**BT-238** Scharf  
**BT-239** Stumpf

AXENFELD  
**BT-240** Scharf  
**BT-241** Stumpf

PAUL  
**BT-242**

Feine Wundhaken flexibel-spitz - Delicate retractors flexible-sharp  
Divaricatori delicati flessibili-acuti - Separadores finos flexibles-agudas

Feine Wundhaken flexibel-stumpf - Delicate retractors flexible-blunt  
Divaricatori delicati flessibili-smussi - Separadores finos flexibles-romas

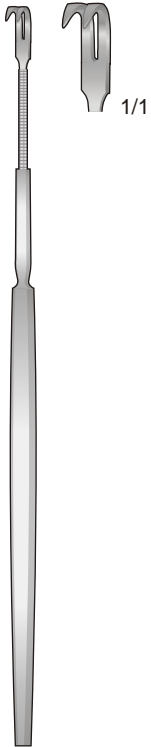

**BT-50**  
150 mm

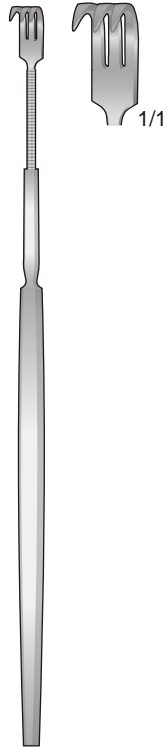

**BT-51**  
150 mm

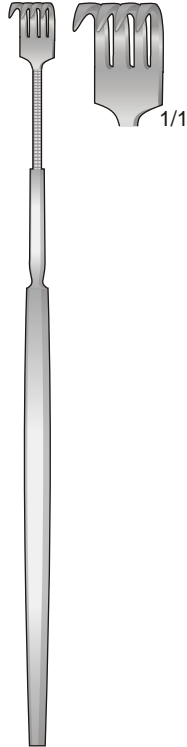

**BT-52**  
150 mm

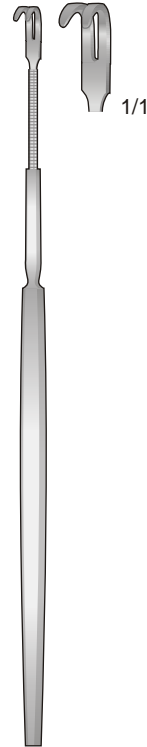

**BT-54**  
150 mm

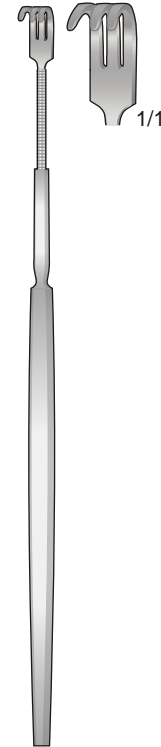

**BT-55**  
150 mm

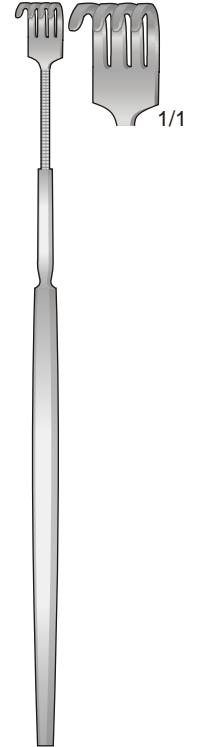

**BT-56**  
150 mm

Wundhaken

Retractors

Divaricatori

Separadores

Ecarteurs

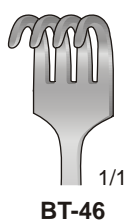
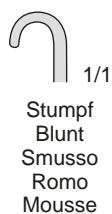
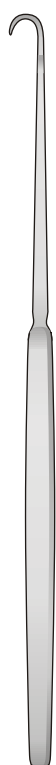

Instrumente zur Nasenplastik  
Instrument for Rhinoplastic

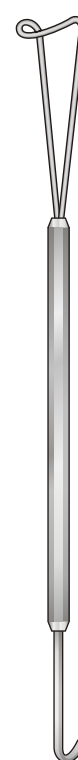
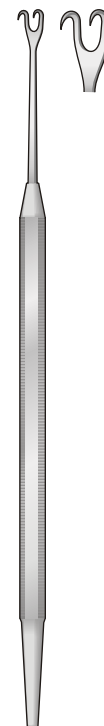

**BT-40/BT-46**  
160 mm

**COTTLE**  
**BT-382**  
150 mm

**NEIVERT**  
**BT-383**  
160 mm

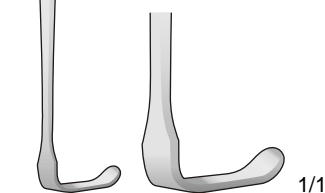
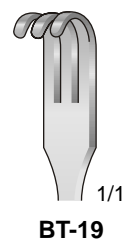
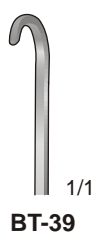
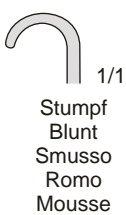
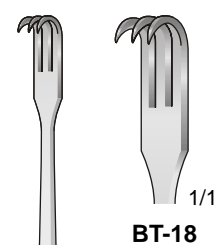
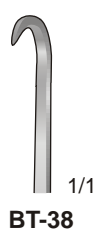
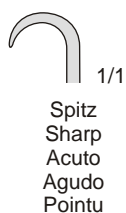

**BT-38/BT-195**  
160 mm

**SENN-MILLER**  
**BT-18/BT-19**  
160 mm

Wundhaken

Retractors

Divaricatori

Separadores

Ecarteurs

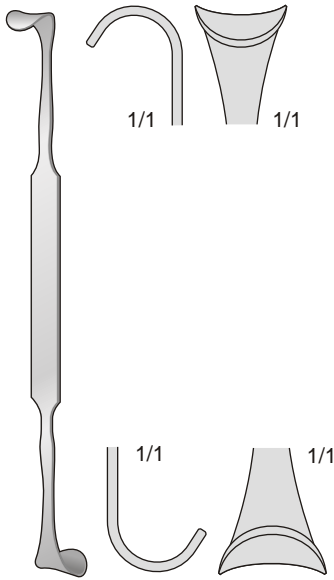

**ROSE  
DS-15**  
130 mm

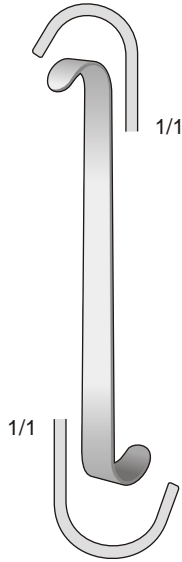

**LUER  
DS-16**  
110 mm

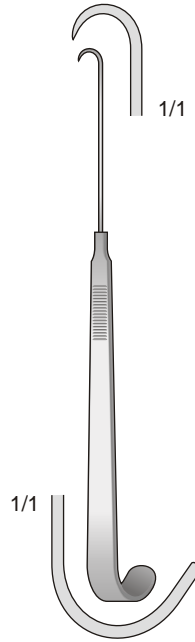

**NEWS  
DS-19**  
150 mm

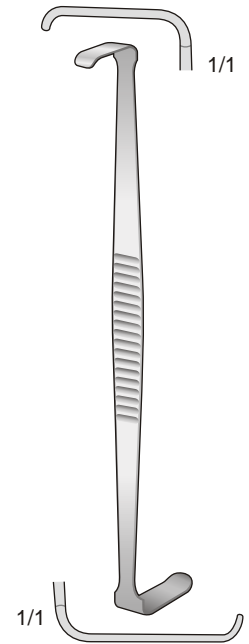

**HOUSE  
DS-20**  
150 mm

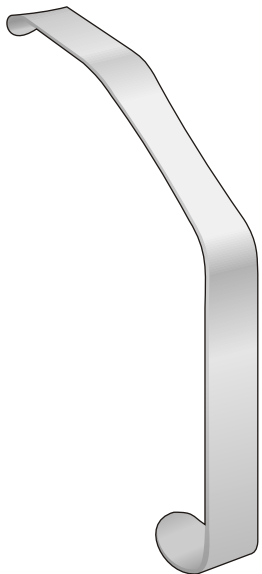

**LOVE  
DO-213/DO-215**  
150 mm

**DO-213** - 18 mm  
**DO-214** - 20 mm  
**DO-215** - 22 mm



**CUSHING  
BT-296/BT-297**  
190 mm



**BT-296**  
1/1

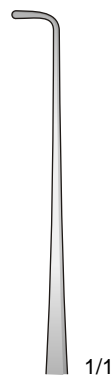

**BT-297**  
1/1



**CUSHING  
BT-298/BT-299**  
280 mm



**BT-298**  
1/1

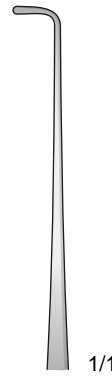

**BT-299**  
1/1

Wundhaken

Retractors

Divaricatori

Separadores

Ecarteurs

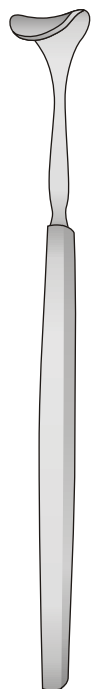

DESMARRES  
BT-70/BT-79  
140 mm



BT-70  
10 mm



BT-72  
14 mm

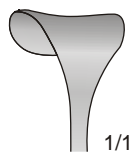

BT-74  
16 mm

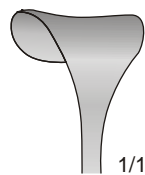

BT-77  
18 mm



BT-71  
12 mm



BT-73  
14 mm



BT-75  
16 mm

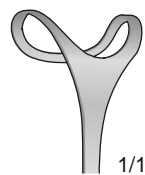

BT-79  
18 mm

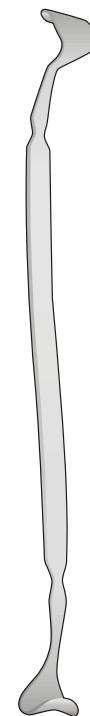

ROSTKOWSKI  
BT-76  
135 mm

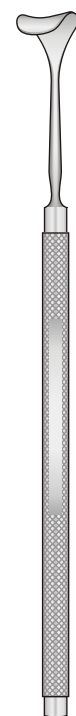

Lidhalter Gr. 2

KIRBY  
BT-244  
140 mm

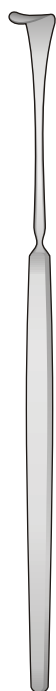

CONWAY  
NK-144  
140 mm



DESMARRES  
NK-145  
140 mm

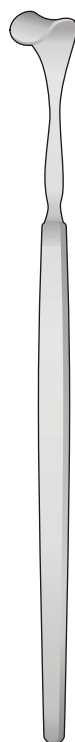

COTTLE  
BT-245  
150 mm

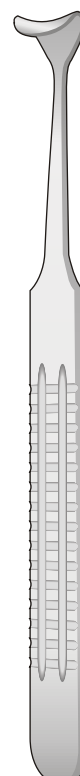

DESMARRES  
BT-28  
160 mm

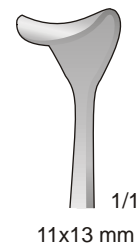

1/1  
11x13 mm

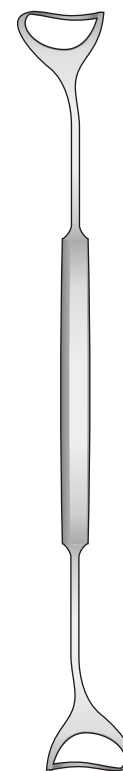

KLAR EVATEUR  
BT-09  
160 mm

Wundhaken

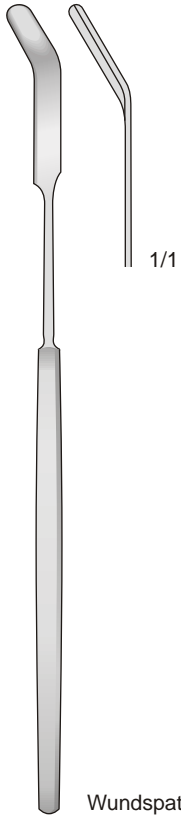

**GIESSEN  
NK-251**

Retractors

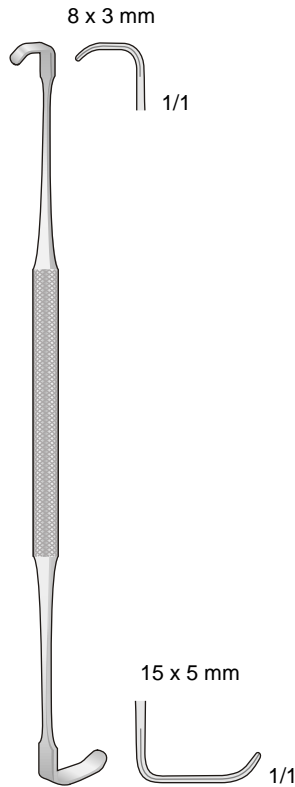

**RAGNELL  
BT-27  
140 mm**

Divaricatori

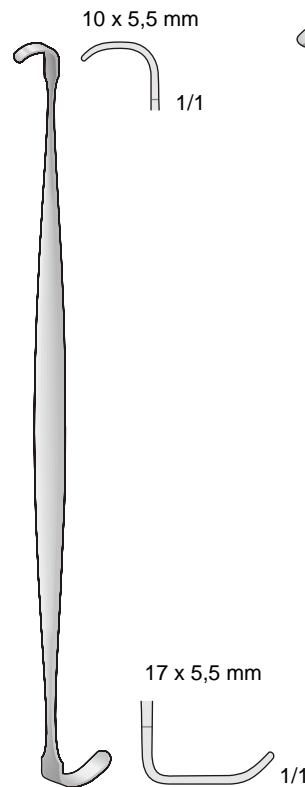

**RAGNELL-DAVIS  
BT-26  
140 mm**

Separadores



**SENN-GREEN  
BT-48/BT-49  
160 mm**

Ecarteurs

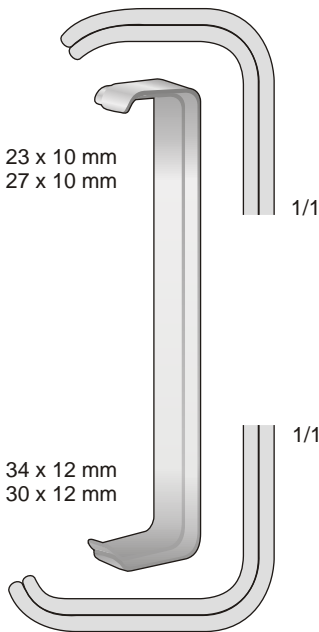
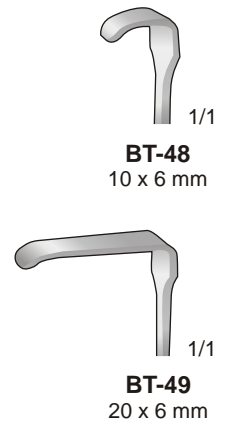

**FARABEUF  
BT-20  
120 mm**

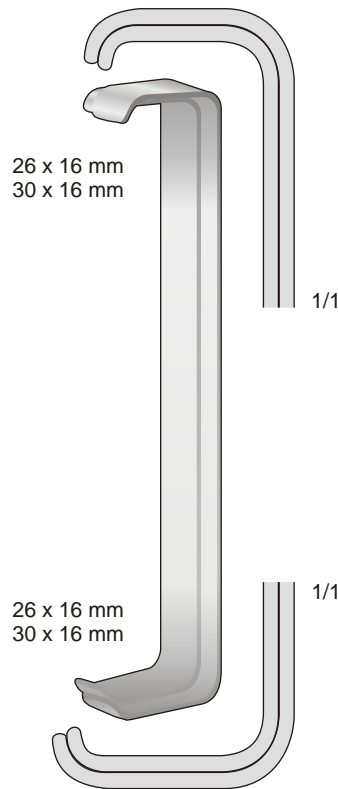

**FARABEUF  
BT-25  
150 mm**

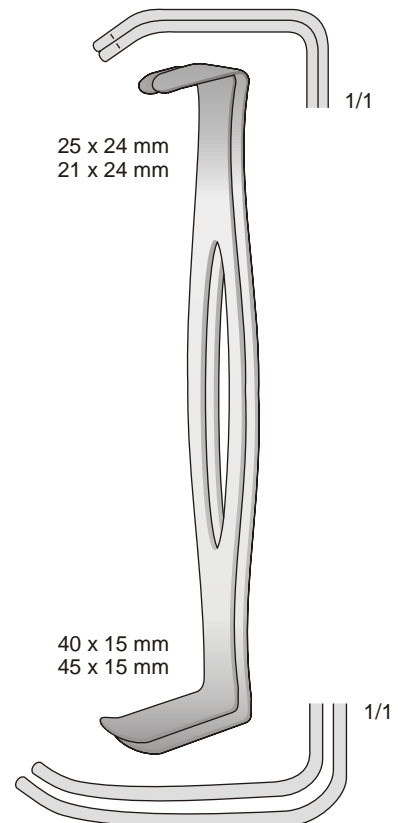

**PARKER-LANGENBECK  
BT-291  
210 mm**



Wundhaken

Retractors

Divaricatori

Separadores

Ecarteurs

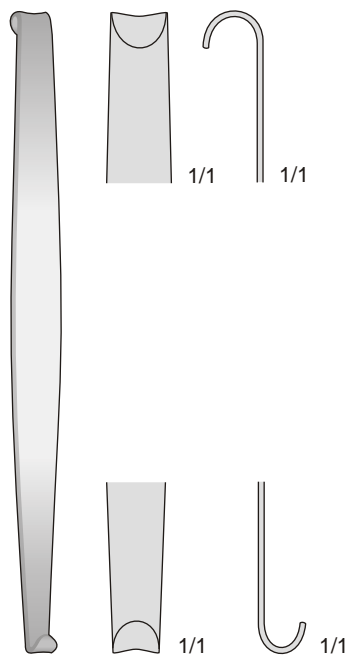

MINI-ROUX  
BT-282  
150 mm



CUSHING  
BT-401/BT-406  
200 mm

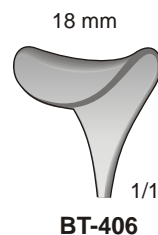

**BT-283**  
Komplettset  
Set complete  
Set completo  
Set completo  
Set complet

29 mm  
26 mm  
22 mm

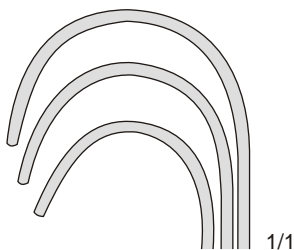

**BT-284** - 20x22 mm  
25x28 mm  
**BT-285** - 23x26 mm  
29x38 mm  
**BT-286** - 29x29 mm  
34x44 mm

28 mm  
38 mm  
44 mm

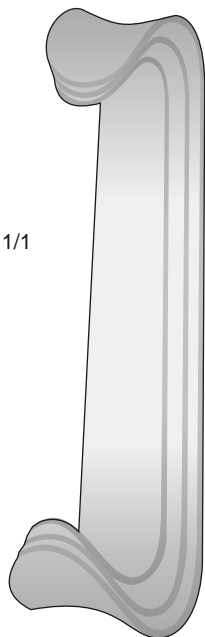

ROUX  
BT-284/BT-286  
165 mm

20x22 mm

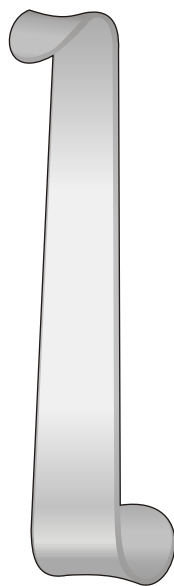

25x28 mm  
ROUX-MAGNUS  
BT-287  
150 mm

23x26 mm

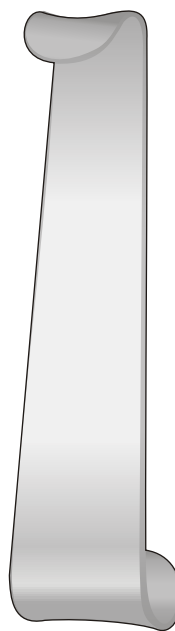

29x38 mm  
ROUX-MAGNUS  
BT-288  
160 mm

29x29 mm

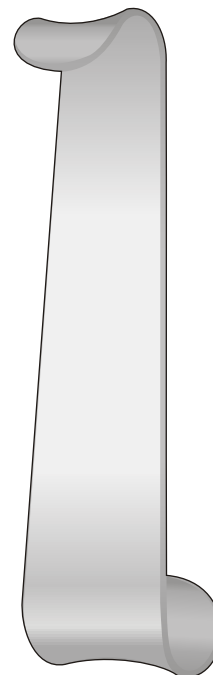

34x44 mm  
ROUX-MAGNUS  
BT-289  
170 mm

Wundhaken

Retractors

Divaricatori

Separadores

Ecarteurs

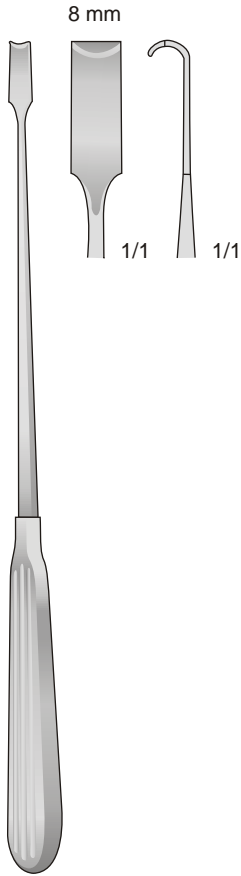

SCOVILLE  
**BT-312**  
230 mm

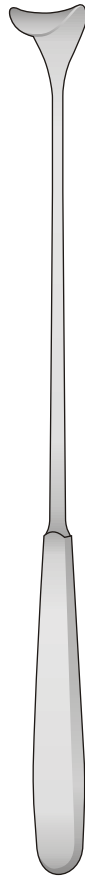

CUSHING  
**BT-114/BT-116**  
250 mm

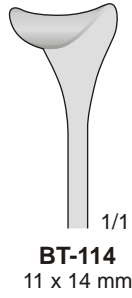

**BT-114**  
11 x 14 mm

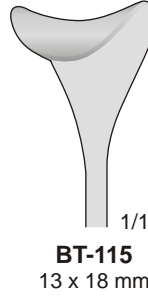

**BT-115**  
13 x 18 mm

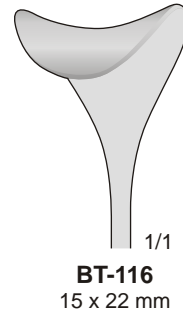

**BT-116**  
15 x 22 mm

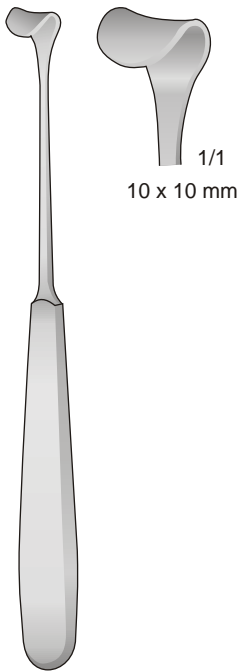

CUSHING-KOCHER  
**BT-113**  
180 mm

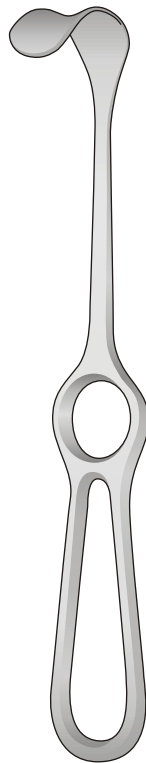

KOCHER  
**BT-117/BT-118**  
205 mm

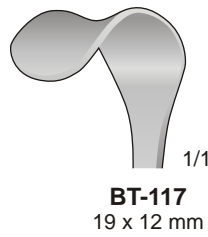

**BT-117**  
19 x 12 mm

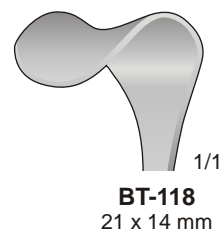

**BT-118**  
21 x 14 mm

Wundhaken

Retractors

Divaricatori

Separadores

Ecarteurs

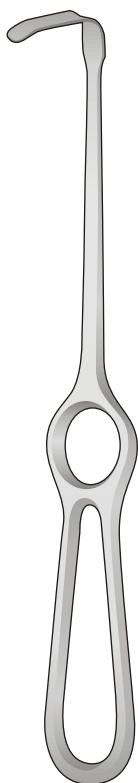

OBWEGESER  
BT-152/BT-157  
220 mm

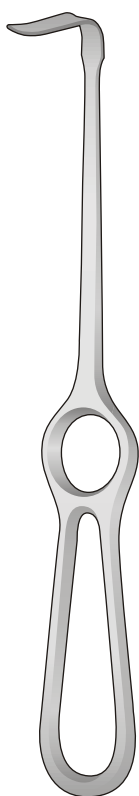

OBWEGESER  
BT-92/BT-100  
220 mm

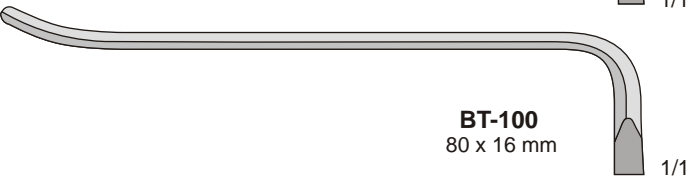
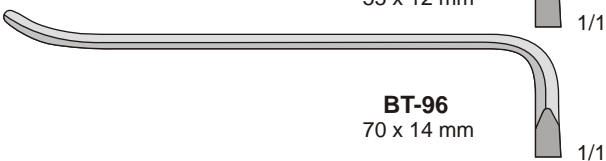
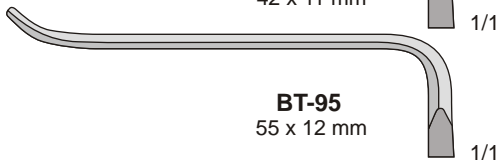
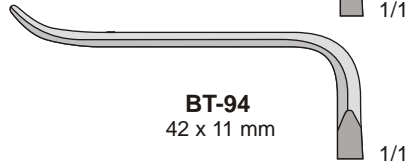
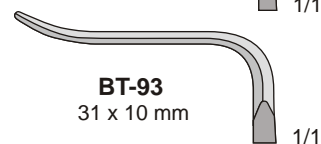
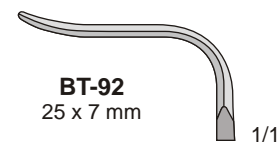
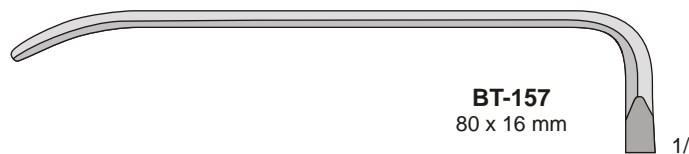
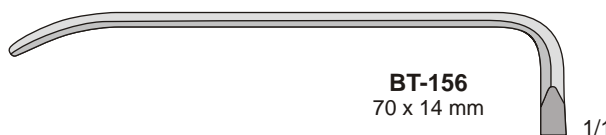
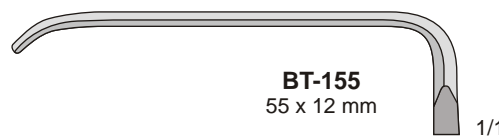
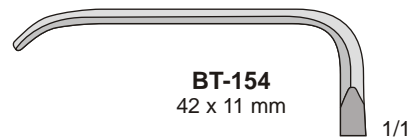
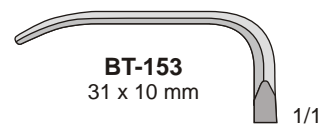
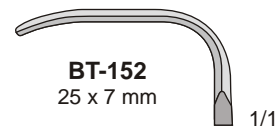

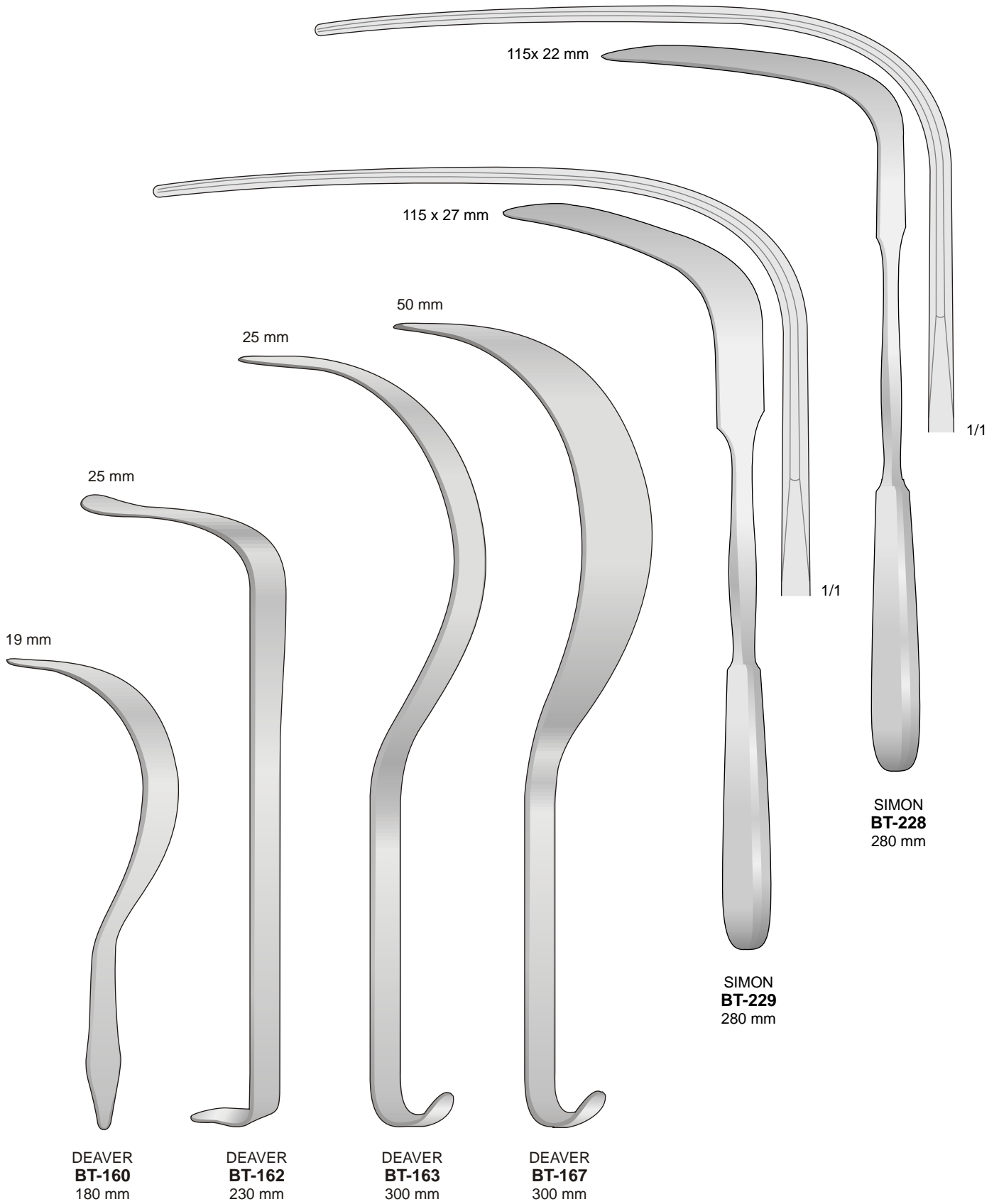

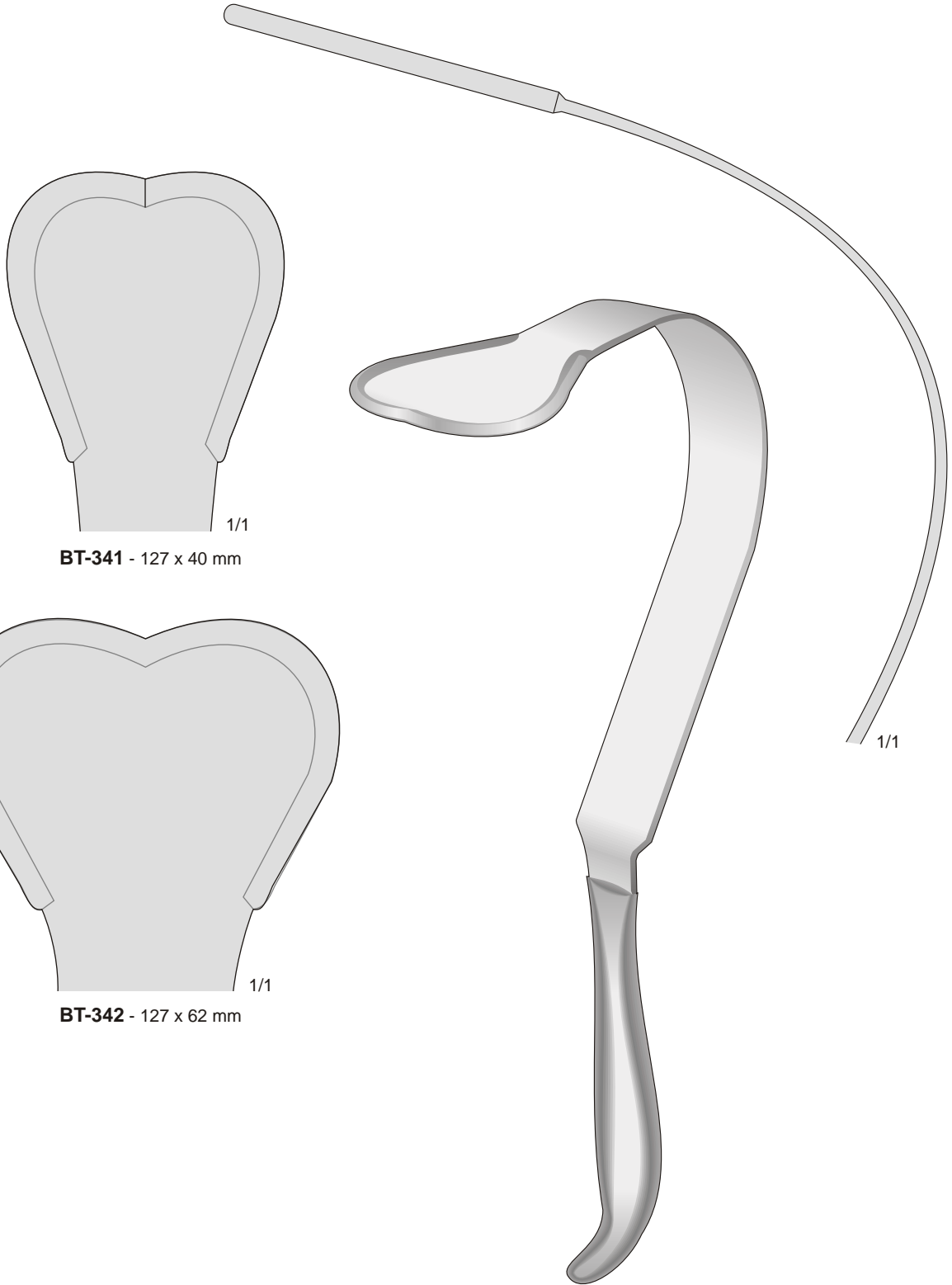

**BT-341** - 127 x 40 mm

**BT-342** - 127 x 62 mm

HARRINGTON  
**BT-341/BT-342**  
320 mm

Wundhaken

Retractors

Divaricatori

Separadores

Ecarteurs

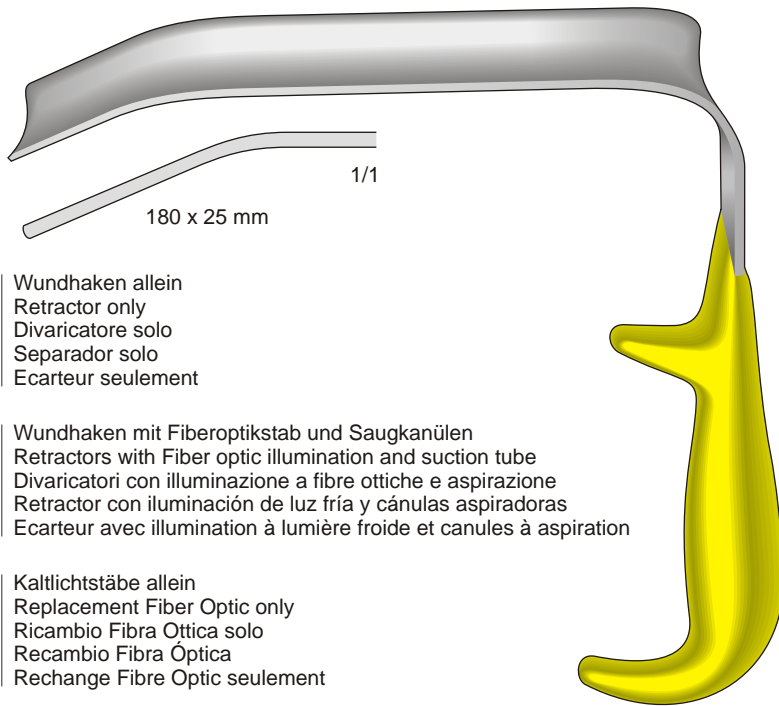

**BT-500** | Wundhaken allein  
Retractor only  
Divaricatore solo  
Separador solo  
Ecarteur seulement

**BT-501** | Wundhaken mit Fiberoptikstab und Saugkanülen  
**BT-502** | Retractors with Fiber optic illumination and suction tube  
Divaricatori con illuminazione a fibre ottiche e aspirazione  
Retractor con iluminación de luz fría y cánulas aspiradoras  
Ecarteur avec illumination à lumière froide et canules à aspiration

**BT-501R** | Kaltlichtstäbe allein  
**BT-502R** | Replacement Fiber Optic only  
Ricambio Fibra Ottica solo  
Recambio Fibra Óptica  
Rechange Fibre Optic seulement

**BT-500**

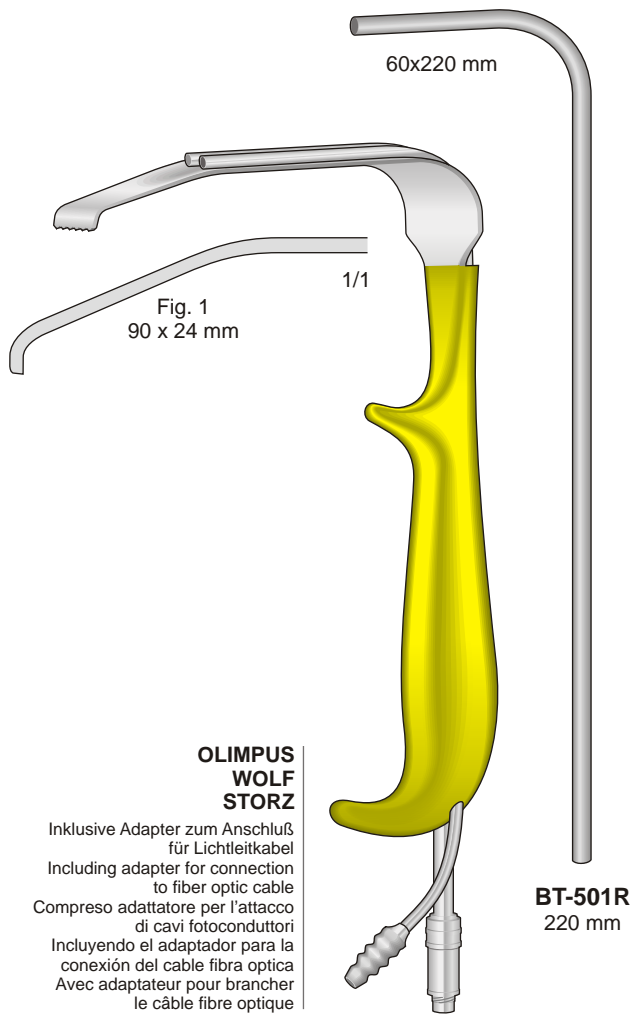

**OLIMPUS  
WOLF  
STORZ**

Inklusive Adapter zum Anschluß für Lichtleitkabel  
Including adapter for connection to fiber optic cable  
Compreso adattatore per l'attacco di cavi fotoconduttori  
Incluyendo el adaptador para la conexión del cable fibra optica  
Avec adaptateur pour brancher le câble fibre optique

**BT-501R**  
220 mm

**BT-501**

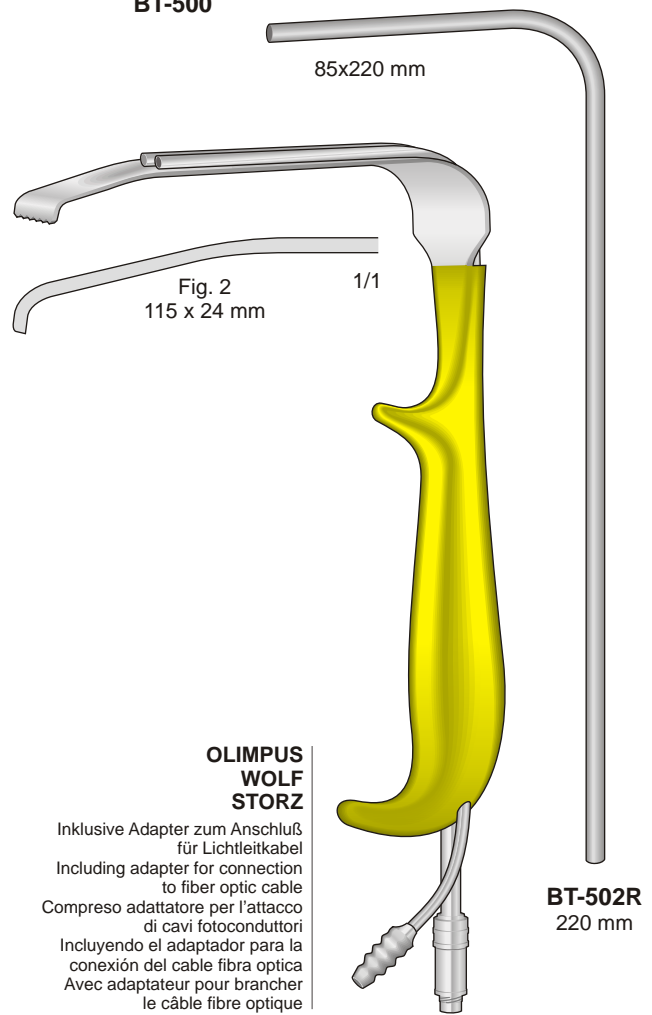

**OLIMPUS  
WOLF  
STORZ**

Inklusive Adapter zum Anschluß für Lichtleitkabel  
Including adapter for connection to fiber optic cable  
Compreso adattatore per l'attacco di cavi fotoconduttori  
Incluyendo el adaptador para la conexión del cable fibra optica  
Avec adaptateur pour brancher le câble fibre optique

**BT-502R**  
220 mm

**BT-502**

Wundhaken

Retractors

Divaricatori

Separadores

Ecarteurs

**BT-503** | Wundhaken mit Fiberoptikstab und Saugkanülen  
**BT-504** | Retractors with Fiber optic illumination and suction tube  
 Divaricatori con illuminazione a fibre ottiche e aspirazione  
 Retractor con iluminación de luz fría y cánulas aspiradoras  
 Ecarteur avec illumination à lumière froide et canules à aspiration

**BT-503R** | Kaltlichtstäbe allein  
**BT-504R** | Replacement Fiber Optic only  
 Ricambio Fibra Ottica solo  
 Recambio Fibra Óptica  
 Rechange Fibre Optic seulement

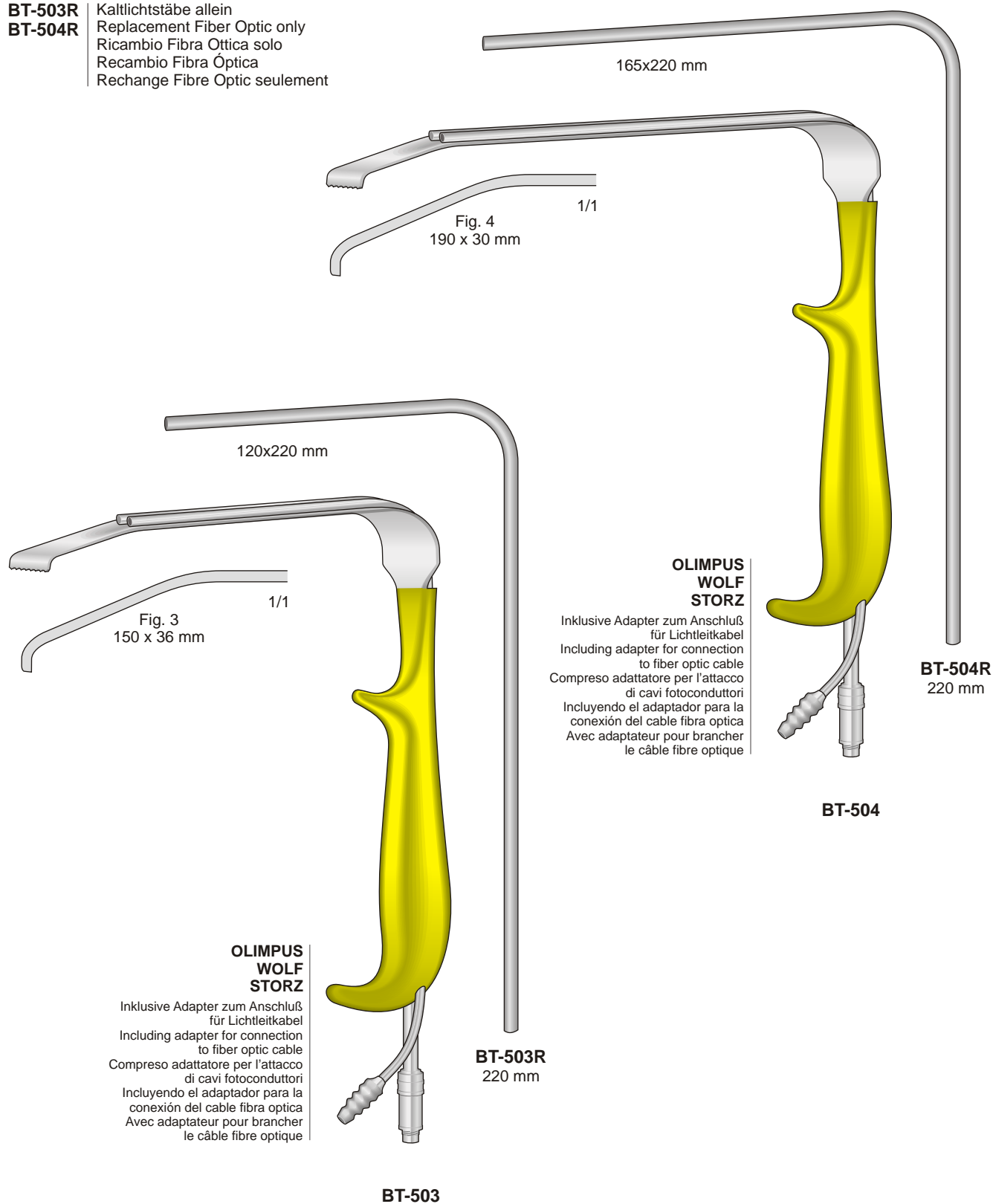

Wundhaken  
Dissektoren

Retractors  
Dissectors

Divaricatori  
Dissettori

Separadores  
Disecadores

Ecarteurs  
Dissecteurs

Brust Spatel, halb-biegsam  
150 mm Langes Blatt  
25 mm breit  
Breast Spatula, semi-malleable  
150 mm blade

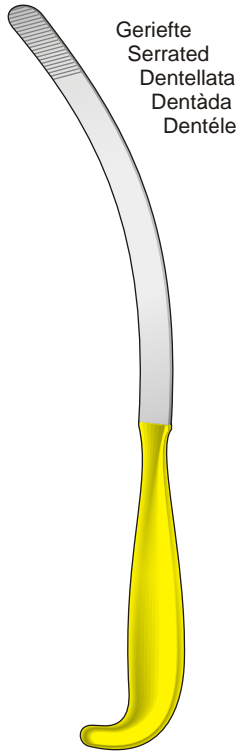

Geriefte  
Serrated  
Dentellata  
Dentada  
Dentéle

**ES-143**  
315 mm

Doppelendiger  
Brustretractor  
Double ended  
Breast Retractor

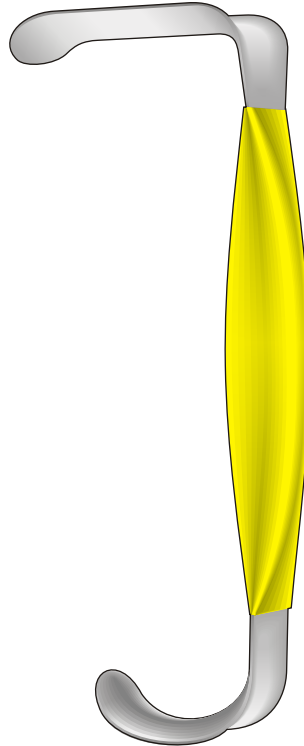

**ES-145**  
310 mm

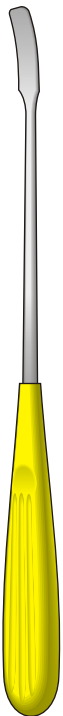

Fig. 1  
Leicht gebogen  
Slight curved  
Curva leggera

**ES-131**  
240 mm

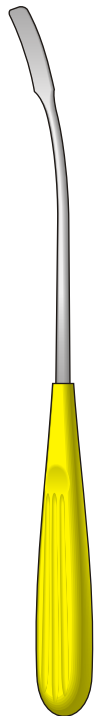

Fig. 2  
Medium gebogen  
Half curved  
Curva media

**ES-132**  
240 mm

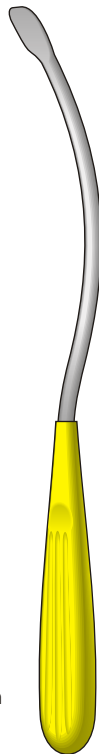

Fig. 3  
Gebogen  
Curved  
Curvo

**ES-133**  
265 mm



Fig. 4  
Gerade  
Straight  
Dritto

**ES-134**  
250 mm

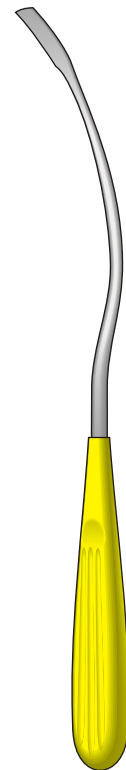

Fig. 5  
S-Form  
S-shaped  
Forma a S

**ES-135**  
280 mm



Dissektoren

Dissectors

Dissettori

Disecadores

Dissecteurs

Breast

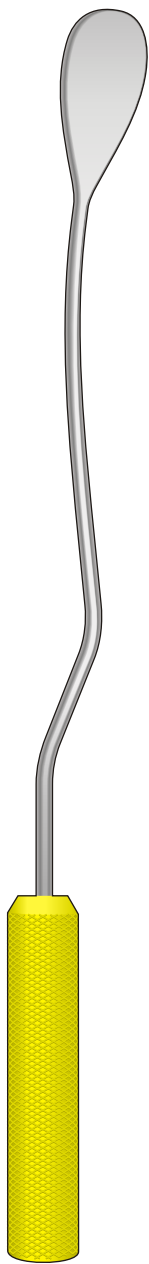

MacCOLLUM-DINGMAN  
**ES-140**  
410 mm

Spatulated Ovale Breast

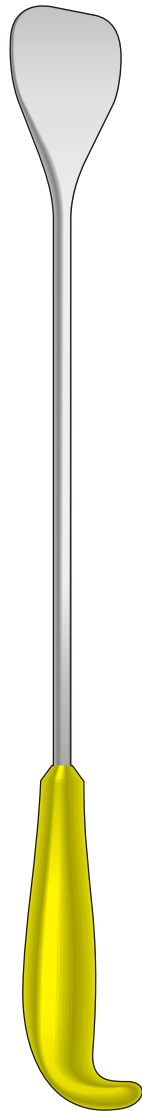

**ES-141**  
330 mm

Angulated Breast

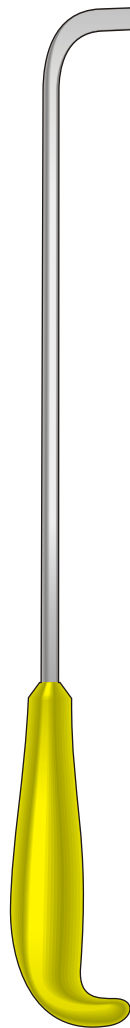

**ES-142**  
330 mm

12 mm

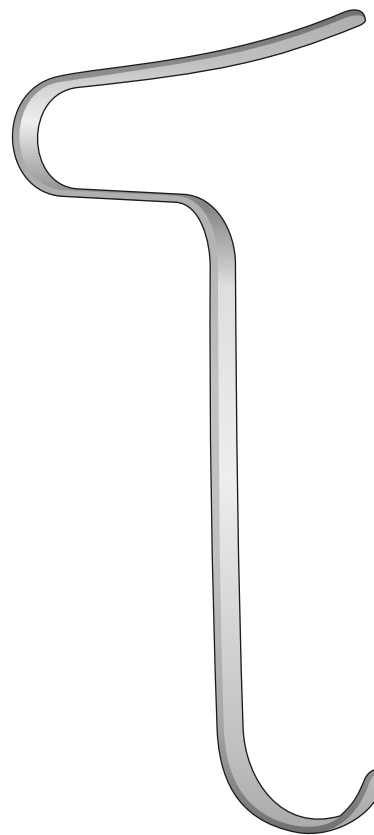

FREEMAN  
**ES-160**  
205 mm

8 mm

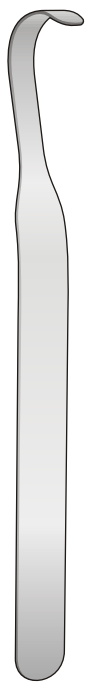

SHEEN  
**ES-162**  
150 mm

Wundhaken

Retractors

Divaricatori

Separadores

Ecarteurs



**MILLARD  
ES-120**

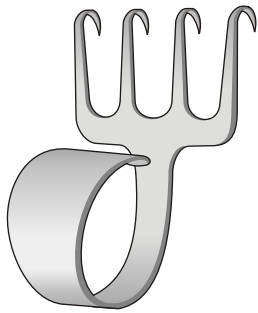

**FREEMAN  
ES-121  
50 mm**

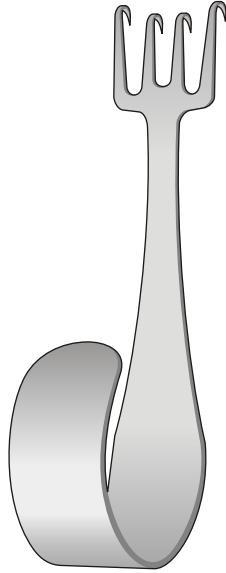

**FREEMAN  
ES-122  
100 mm**

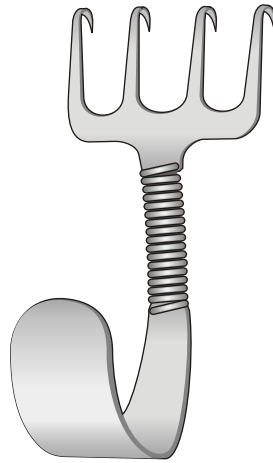

**GORNEY  
ES-123  
75 mm**

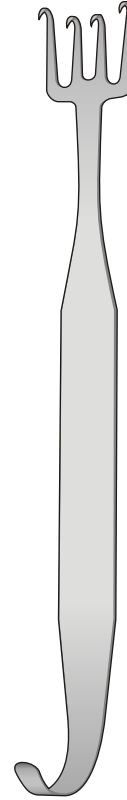

**FREEMAN  
ES-124  
180 mm**

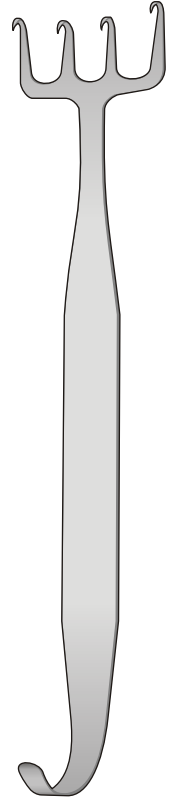

**FREEMAN  
ES-125  
180 mm**

Coronal Left Wundhaken  
Coronal Lift Retractor  
Divaricatore coronale

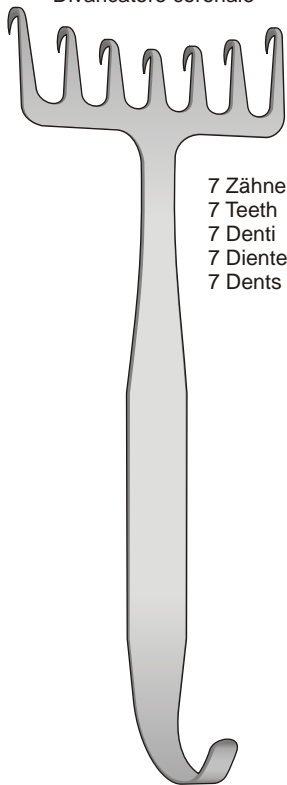

**CORONAL  
ES-126  
180 mm**

7 Zähne  
7 Teeth  
7 Denti  
7 Dientes  
7 Dents

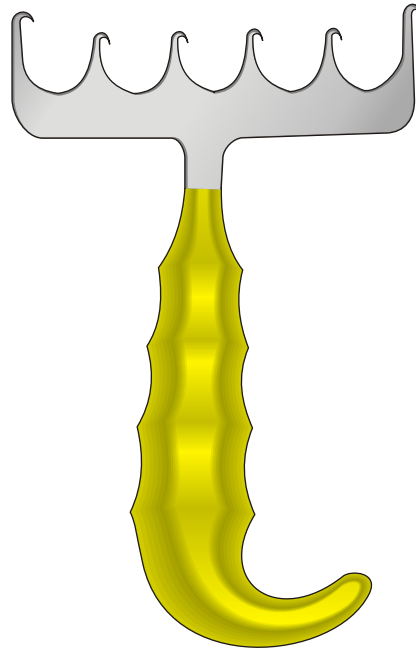

**YANCOSKIE  
ES-127  
150 mm**

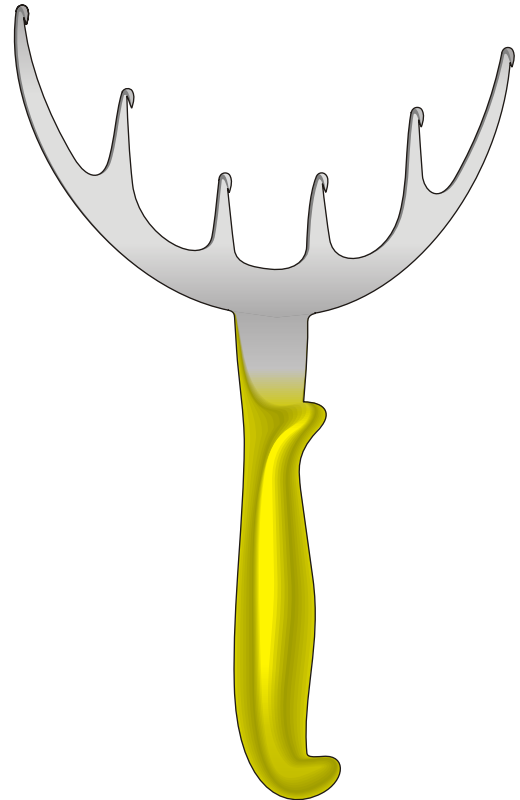

**FREEMAN  
ES-128  
180 mm**

Wundhaken

Retractors

Divaricatori

Separadores

Ecarteurs

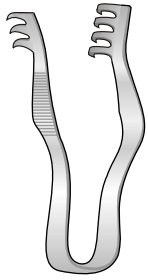

FINSEN  
BV-36/BV-39  
50 mm

Spitz 3x2 Zähne  
Sharp 3x2 Teeth  
Acuto 3x2 Denti  
Agudas 3x2 Dientes  
Pointü 3x2 Griffes

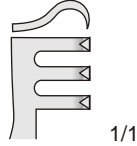

1/1

BV-36

Stumpf 3x2 Zähne  
Blunt 3x2 Teeth  
Smusso 3x2 Denti  
Romas 3x2 Dientes  
Mousse 3x2 Griffes

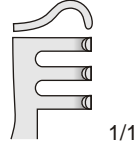

1/1

BV-37

Spitz 3x4 Zähne  
Sharp 3x4 Teeth  
Acuto 3x4 Denti  
Agudas 3x4 Dientes  
Pointü 3x4 Griffes

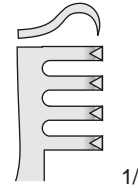

1/1

BV-38

Stumpf 3x4 Zähne  
Blunt 3x4 Teeth  
Smusso 3x4 Denti  
Romas 3x4 Dientes  
Mousse 3x4 Griffes

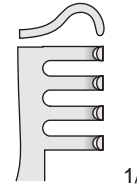

1/1

BV-39

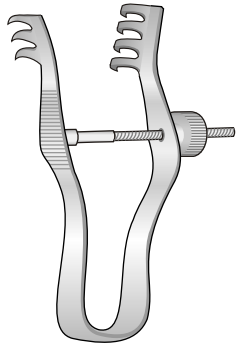

FINSEN  
BV-47/BV-48  
70 mm

Spitz 3x4 Zähne  
Sharp 3x4 Teeth  
Acuto 3x4 Denti  
Agudas 3x4 Dientes  
Pointü 3x4 Griffes

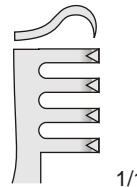

1/1

BV-47

Stumpf 3x4 Zähne  
Blunt 3x4 Teeth  
Smusso 3x4 Denti  
Romas 3x4 Dientes  
Mousse 3x4 Griffes

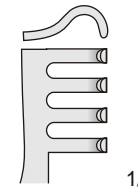

1/1

BV-48

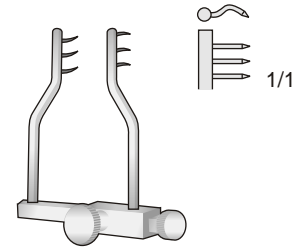

LOGAN  
BV-45  
40 mm

Spitz  
Sharp  
Acuto  
Agudas  
Pointü

Stumpf  
Blunt  
Smusso  
Romas  
Mousse

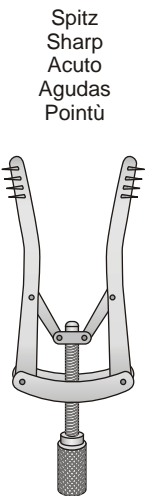

ALM  
BV-12  
70 mm

Stumpf  
Blunt  
Smusso  
Romas  
Mousse

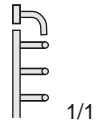

1/1

BV-49  
70 mm

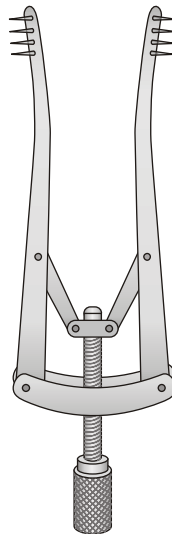

ALM  
BV-10  
100 mm

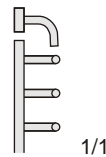

1/1

BV-51  
100 mm



BV-08  
100 mm

Wundhaken

Retractors

Divaricatori

Separadores

Ecarteurs

Spitz  
Sharp  
Acuto  
Agudo  
Pointu

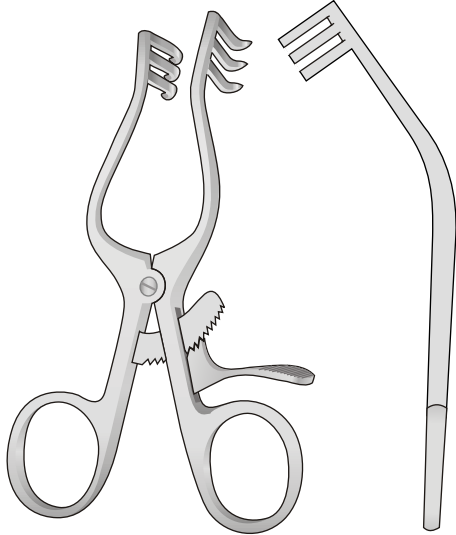
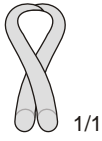

**WULLSTEIN  
BV-111**  
105 mm

Stumpf  
Blunt  
Smusso  
Romo  
Mousse

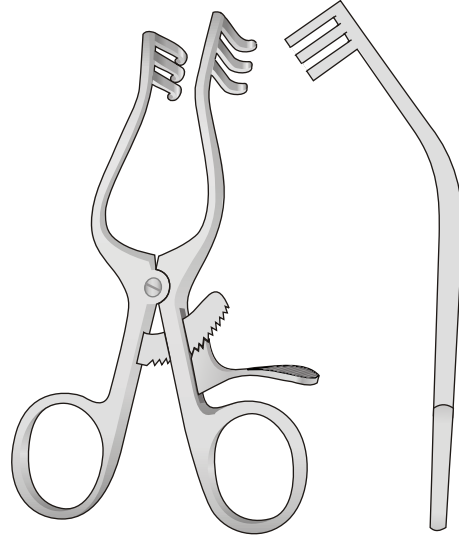
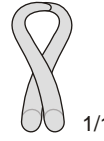

**WULLSTEIN  
BV-112**  
105 mm

Spitz  
Sharp  
Acuto  
Agudo  
Pointu

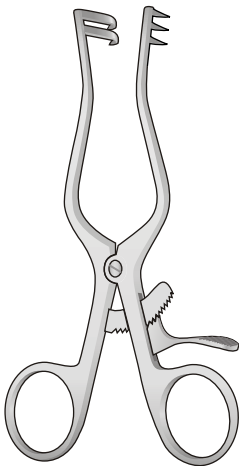

**WEITLANER  
BV-07**  
110 mm

Stumpf  
Blunt  
Smusso  
Romo  
Mousse

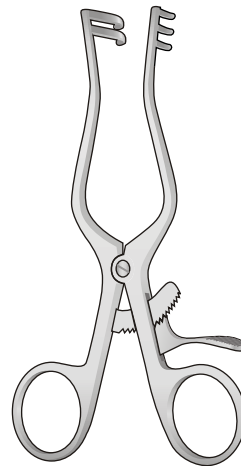

**WEITLANER  
BV-09**  
110 mm

Wundhaken

Retractors

Divaricatori

Separadores

Ecarteurs

Spitz  
Sharp  
Acuto  
Agudo  
Pointu

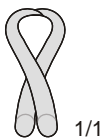

Stumpf  
Blunt  
Smusso  
Romo  
Mousse

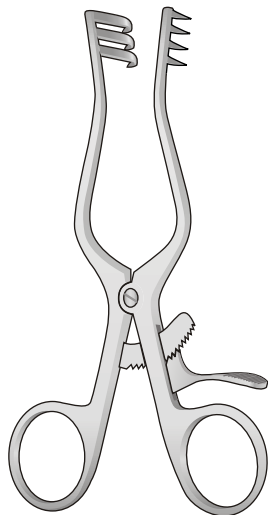

WEITLANER  
**BV-20**  
135 mm

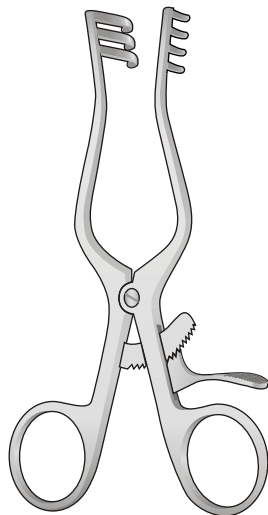

WEITLANER  
**BV-22**  
135 mm

Spitz - Sharp  
Acuto - Agudo  
Pointu

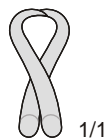

Stumpf - Blunt  
Smusso - Romo  
Mousse

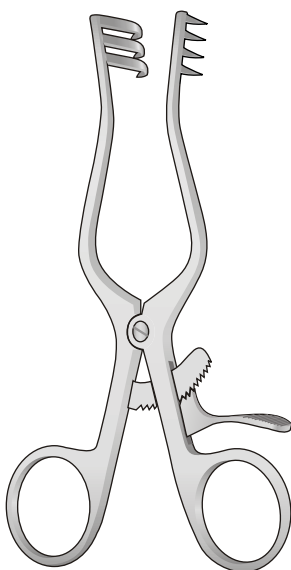

WEITLANER  
**BV-21**  
165 mm

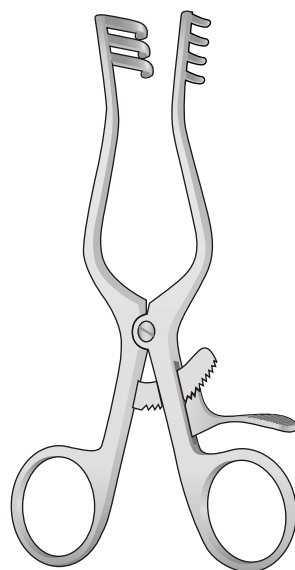

WEITLANER  
**BV-23**  
165 mm

Acuto  
Scharp  
Spitz  
Pointu  
Agudo

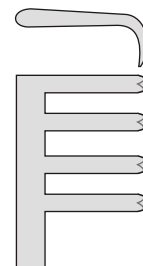

**BV-68**  
140 mm

Smusso  
Blunt  
Stumpf  
Mousse  
Romas

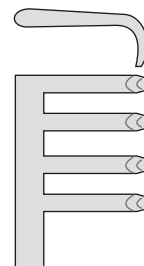

**BV-70**  
140 mm

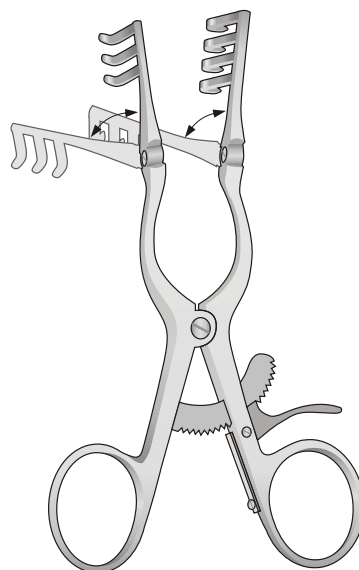

ADSON  
**BV-68/BV-70**  
140 mm

Spitz - Sharp - Acuto  
Agudas - Pointu

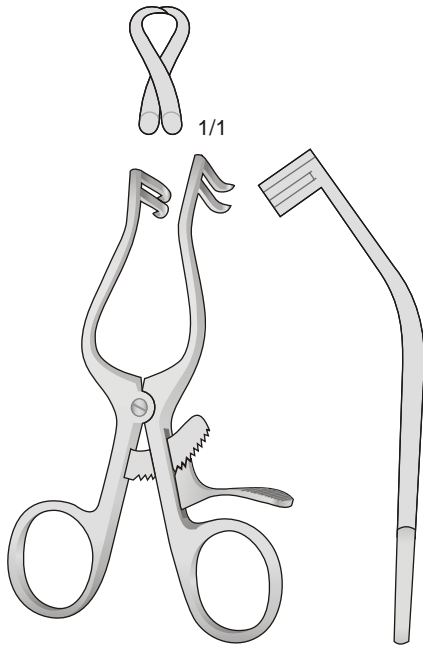

PLESTER  
**BV-90**  
110 mm

Stumpf - Blunt - Smusso  
Romas - Mousse

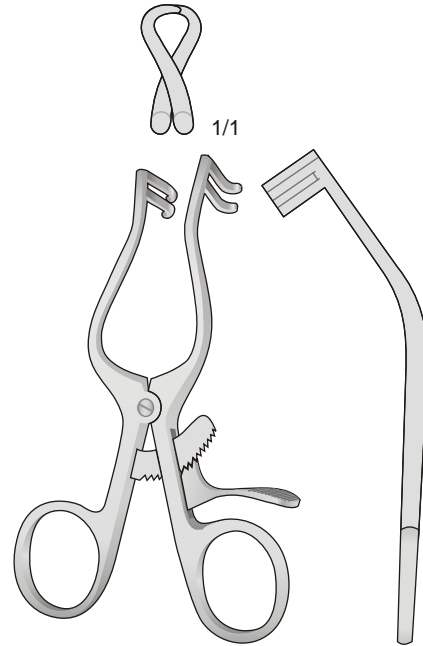

PLESTER  
**BV-91**  
110 mm

Spitz - Sharp - Acuto  
Agudas - Pointu

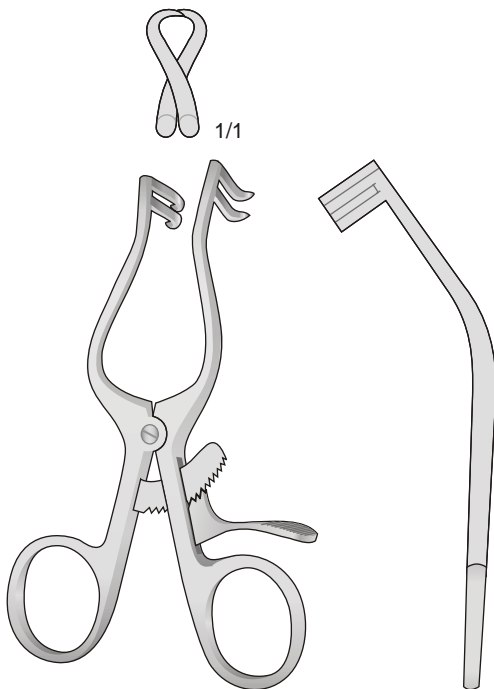

PLESTER  
**BV-92**  
135 mm

Stumpf - Blunt - Smusso  
Romas - Mousse

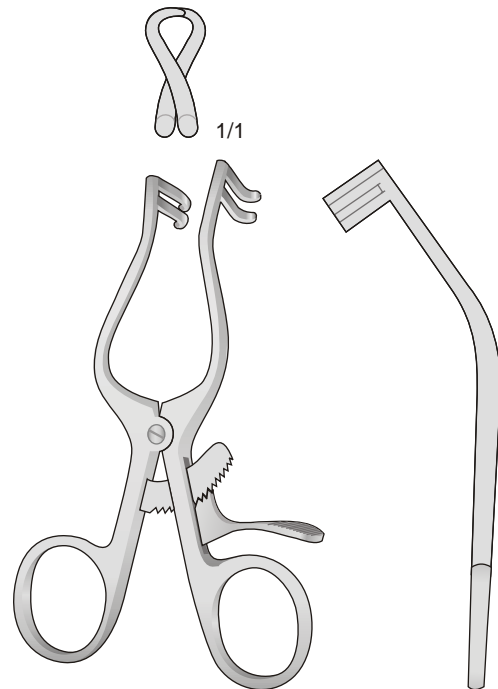

PLESTER  
**BV-93**  
135 mm

Haken Stripper

Vein Stripper

Uncini per vene

Sonda para varices

Stripper a anneau

Varizeninstrumente  
 Varix Instruments  
 Strumenti per varici  
 Instrumentos para varices  
 Instruments pour varices

Phlebodissektor - Phlebodissector  
 Flebodisettore - Flebodisecador  
 Dissecteur pour phlébite

**ES-150**  
 Komplettsset mit  
 Set complete with  
 Set completo con  
 Set completo con  
 Set complete avec  
**ES-151 + ES-152 + ES-153**

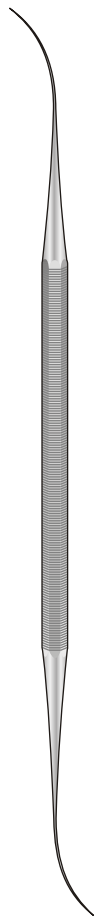

VARADY  
**FB-107**  
 180 mm

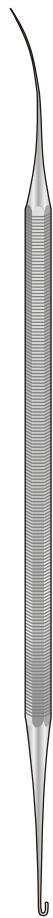

VARADY  
**FB-108**  
 180 mm



VARADY  
**FB-109**  
 180 mm

Fig. 1



**ES-151**  
 140 mm

Fig. 2

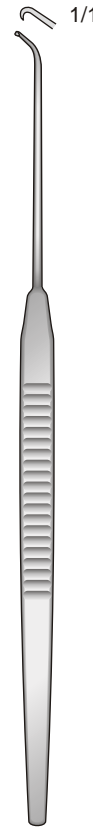

**ES-152**  
 140 mm

Fig. 3

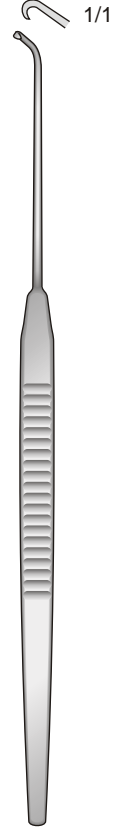

**ES-153**  
 140 mm

Venen-Stripper-  
Instrumente

Vein Stripper  
instruments

Strumenti per stripping  
di vene

Instrumentos para  
varices

Instruments pour  
stripping veineux

**FB-390**  
Krampfaderbesteck komplett  
Varicose Vein Probe Set complete  
Set completo sonda per varici  
Juego para varices completo  
Trousse à varices complète

Metall-Sondenspitzen  
Probe tip, metal  
Punta per sonda  
in metallo  
Punta metálica  
Pointe en métal

Ø 3 mm

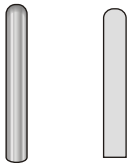

**FB-394**

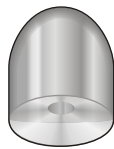

**FB-395/FB-398**



Ø 6 mm

**FB-395**



Ø 9 mm

**FB-396**



Ø 12 mm

**FB-397**

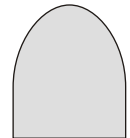

Ø 15 mm

**FB-398**

Oliven - Olives - Olive - Oliva - Olive

Griff Allein  
Handle only  
Manico solo  
Mango solo  
Manche seule

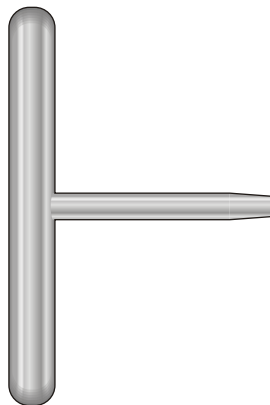

**FB-400**

Zugseil  
Traction Cable  
Cavo per trazione  
Cable de tracción  
Cable tracteur

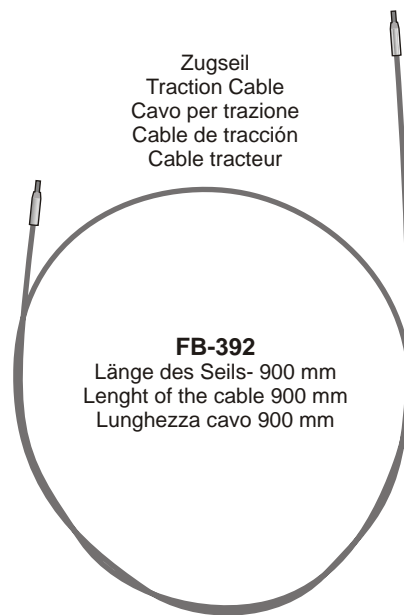

**FB-392**  
Länge des Seils- 900 mm  
Length of the cable 900 mm  
Lunghezza cavo 900 mm



Wundhaken

Retractors

Divaricatori

Separadores

Ecarteurs

Nasenhaken  
Nasal Retractors  
Divaricatori nasali  
Separadores nasales  
Ecarteurs nasaux

Wundhaken mit Fiberoptikstab oval  
Retractors with Fiber optic oval  
Divaricatore a fibra ottica ovale  
Retractor con iluminación de luz fría  
Ecarteur avec illumination à lumière froide

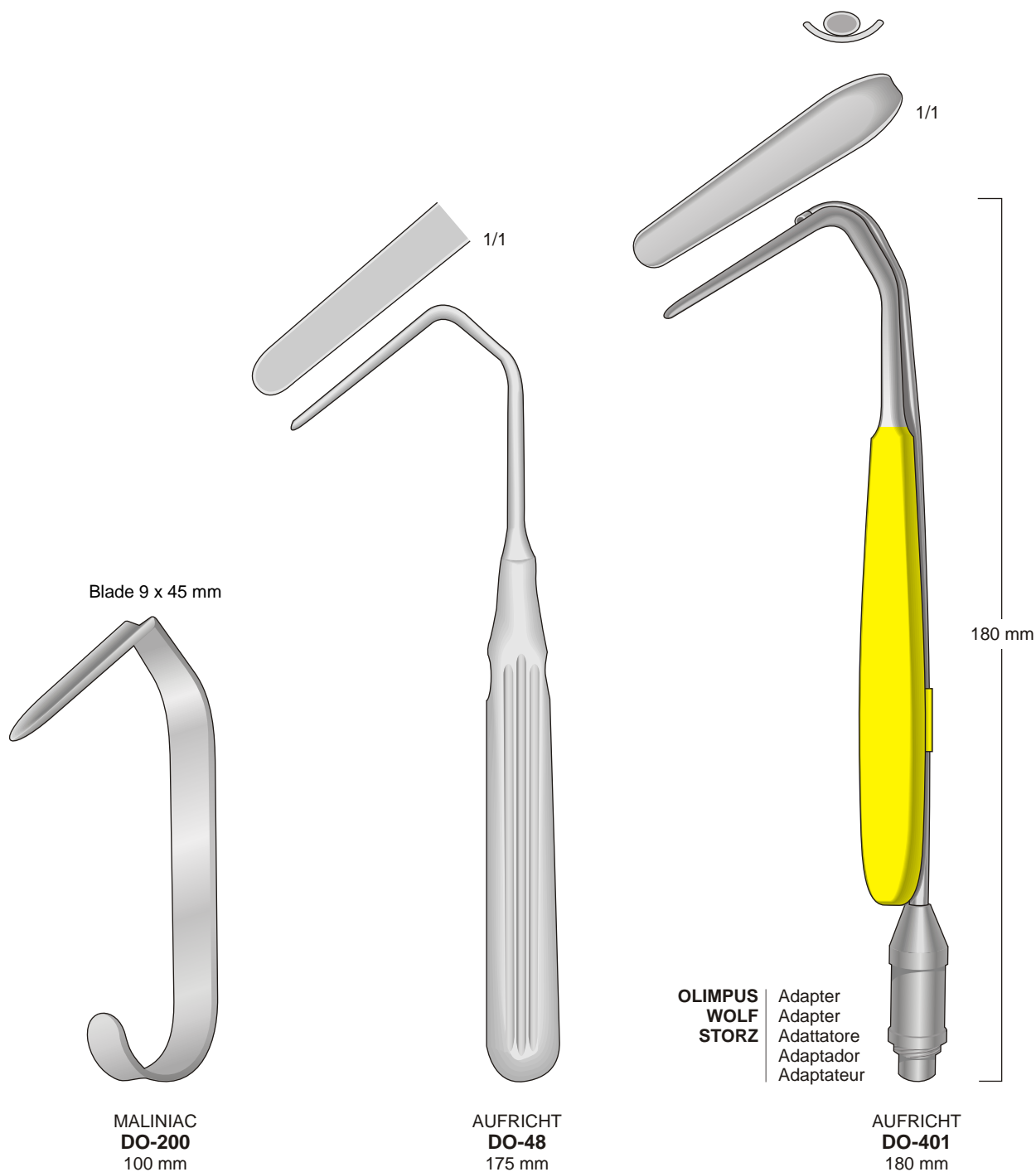

Nasen Spekula  
 Nasal specula  
 Speculum nasali  
 Espéculos nasales  
 Spéculums nasaux

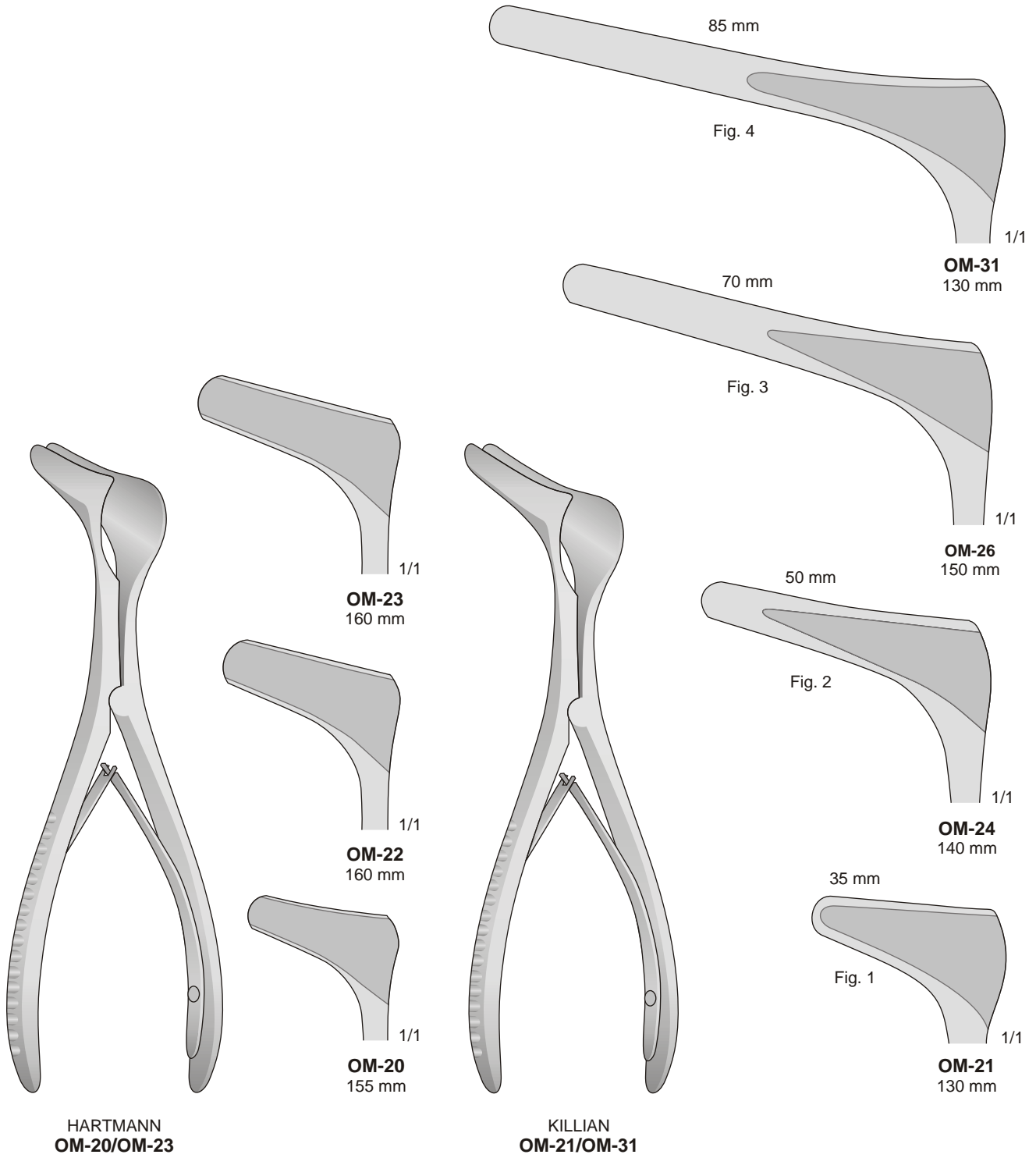

Nasen Spekula  
 Nasal specula  
 Speculum nasali  
 Espéculos nasales  
 Spéculums nasaux

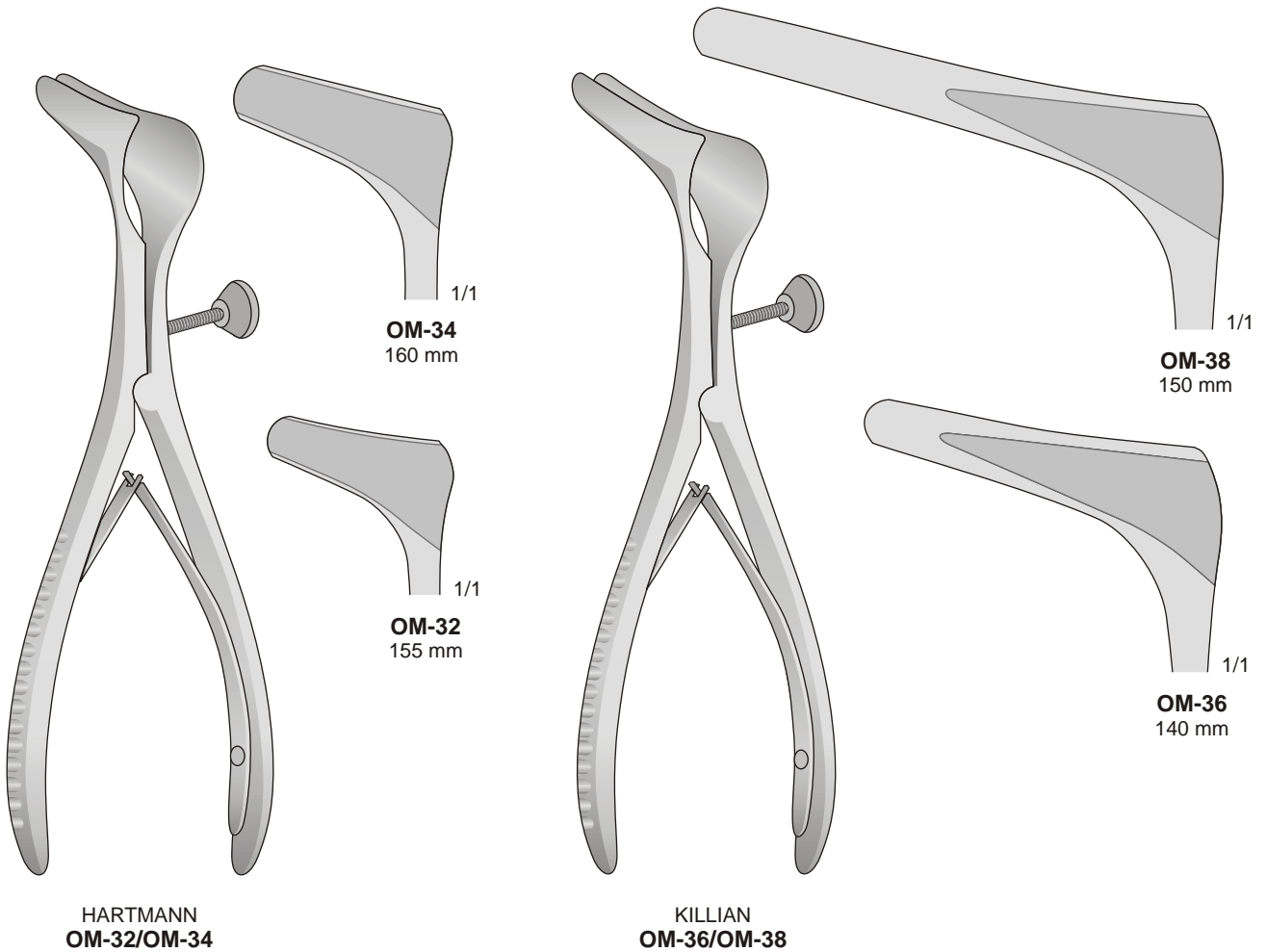

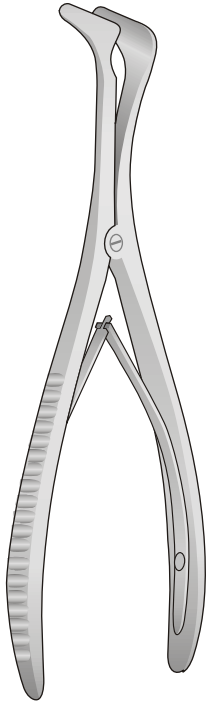

**TIECK-HALLE**  
**OM-48/OM-49**  
135 mm

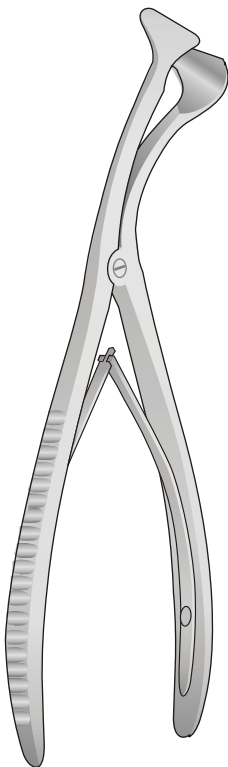
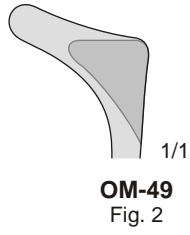
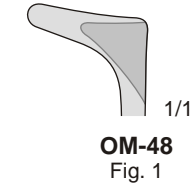

**BECKMANN**  
**OM-51/OM-54**  
150 mm

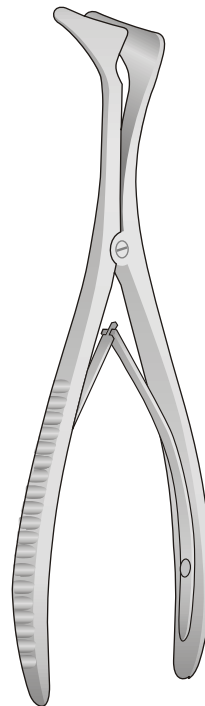
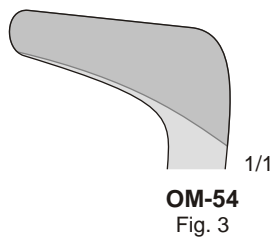
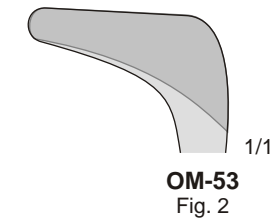
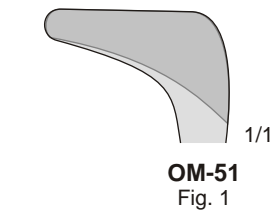

**MODELL WIEN**  
**OM-56/OM-59**  
140 mm

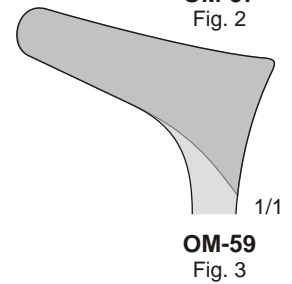
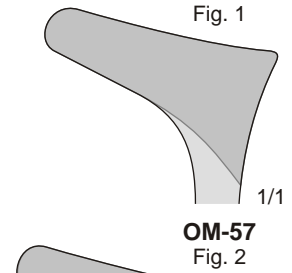
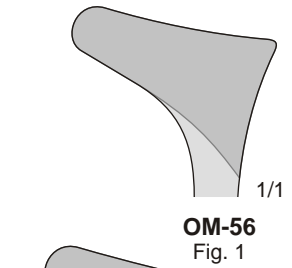

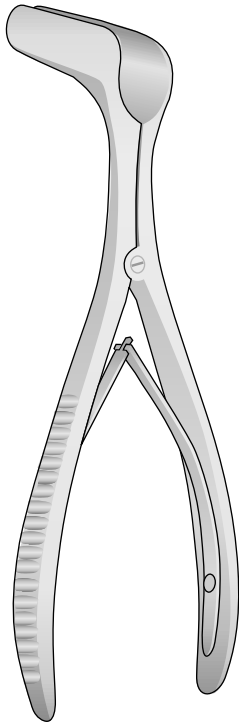

**PAPAVERO-HARTMANN**  
**OM-39**  
140 mm

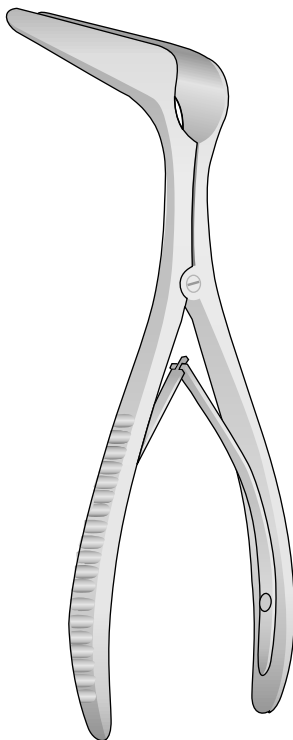

**COTTLE**  
**OM-25/OM-29**  
150 mm

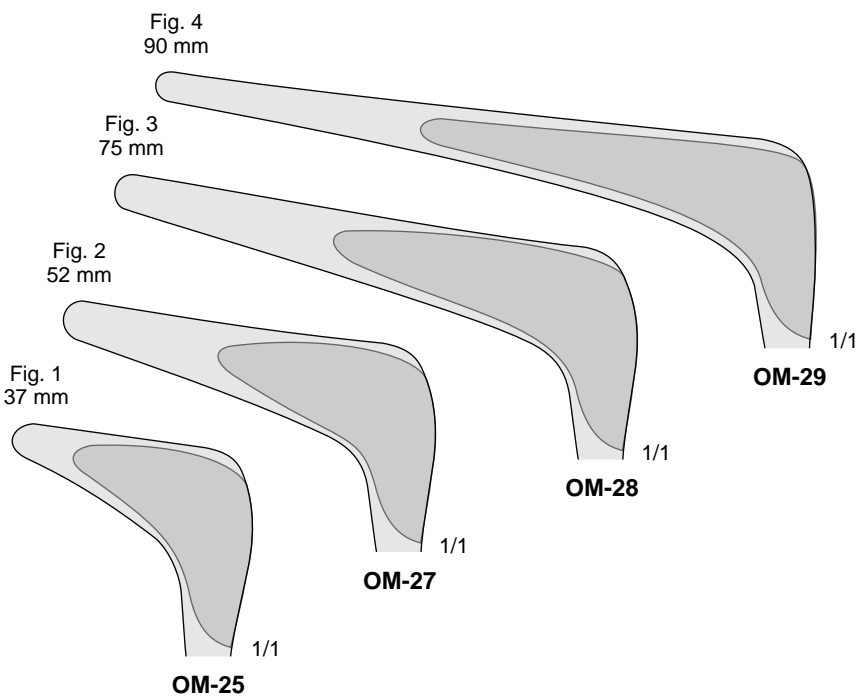





SADIQ SURGICAL CO.

Catalogue 2015 / 2016



7

Raspatorien, Elevatorien  
Raspatories, Elevators  
Periostotomi, Elevatori  
Raspadores, Elevadores  
Rugines, Elevateurs





Elevatorii

Elevators

Elevatori

Elevadores

Elevateurs

Raspatorii  
 Periosteal Raspatories  
 Periostotomi  
 Legras periostotomos  
 Rugines à périostomie

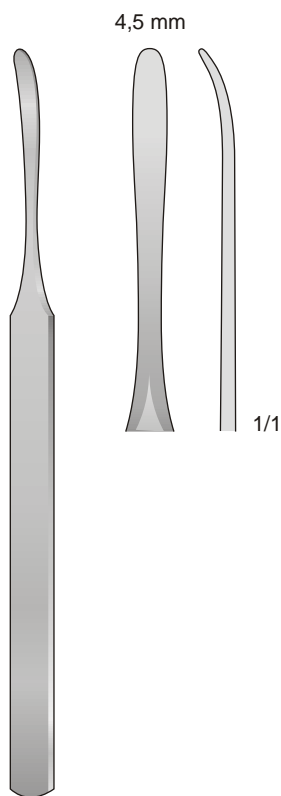

**KÖNIG  
 KO-1**  
 155 mm

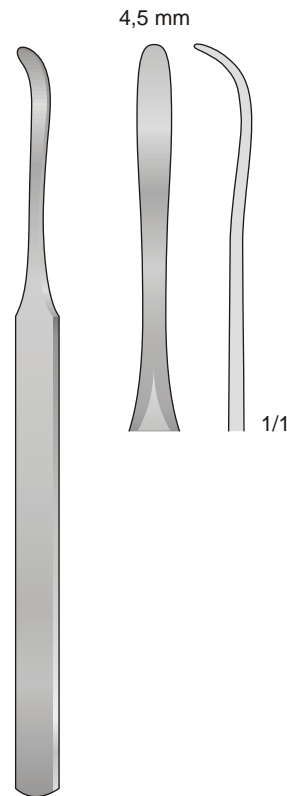

**KÖNIG  
 KO-2**  
 155 mm

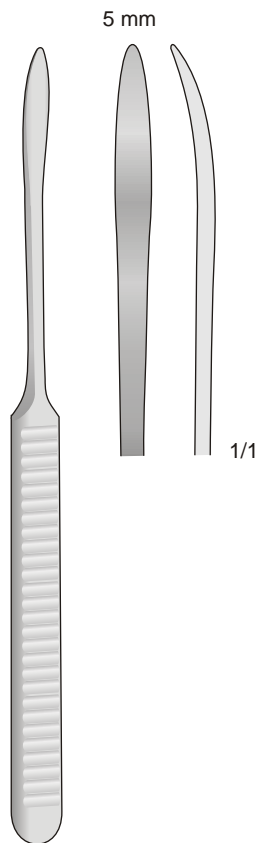

**WILLIGER  
 WG-10**  
 165 mm

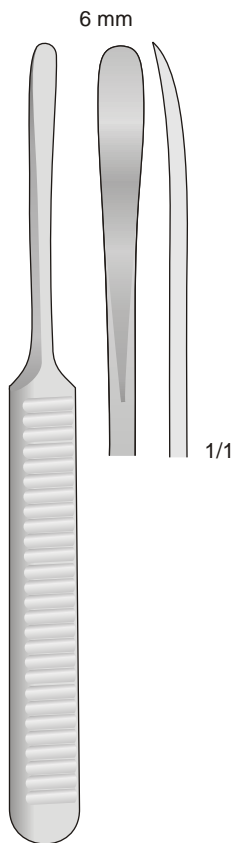

**WILLIGER  
 WG-12**  
 160 mm

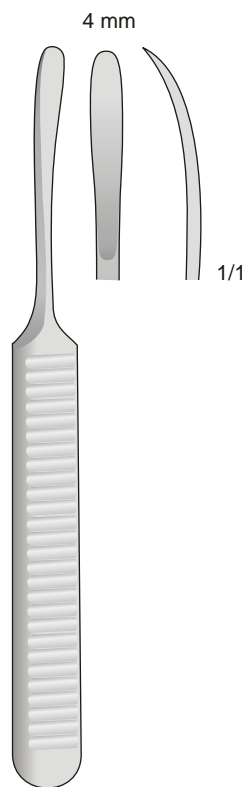

**WILLIGER  
 WG-14**  
 140 mm

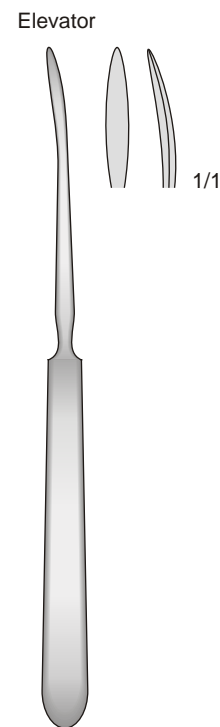

**LUENEBURG  
 FR-10**  
 115 mm

Dissektoren  
Separatoren

Dissectors  
Seperators

Dissettori  
Separatori

Disecadores  
Descoladores

Dissecteurs  
Separateurs

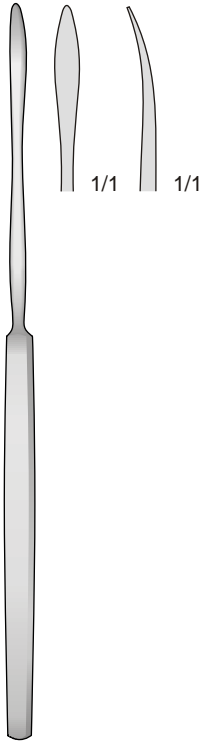

**KO-18**  
175 mm

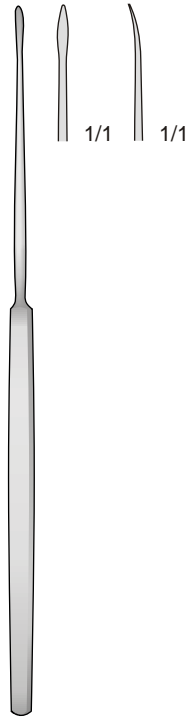

**KO-19**  
160 mm



**YANKAUER  
KO-54**  
210 mm

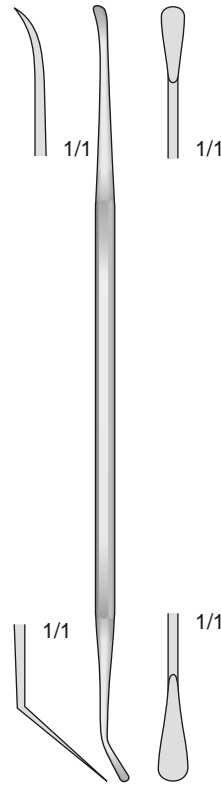

**MILLIGAN  
KO-27**  
210 mm

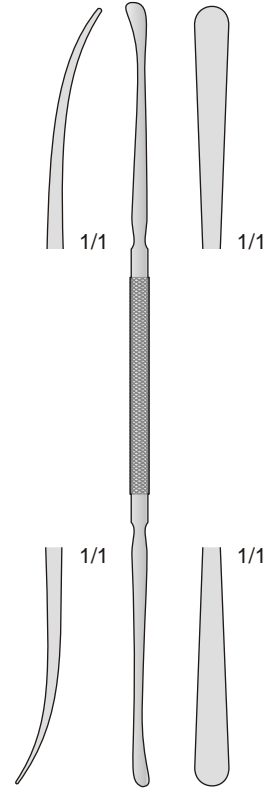

**DAVIS  
KO-21**  
245 mm

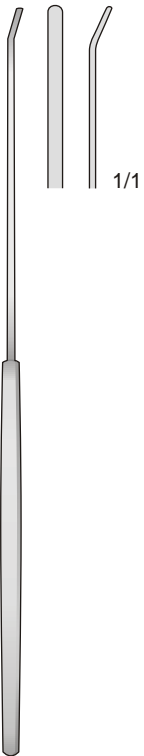

**FAGER  
KO-24**  
200 mm

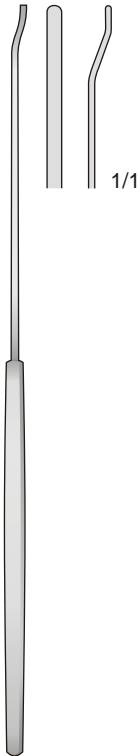

**FAGER  
KO-25**  
200 mm

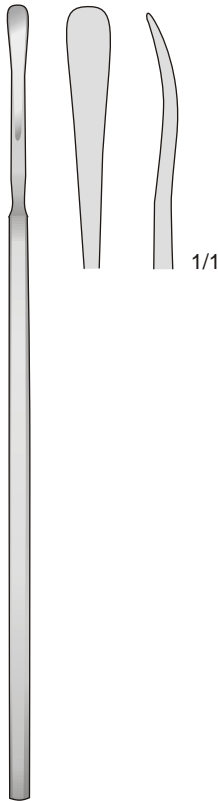

**SACHS  
KO-26**  
210 mm

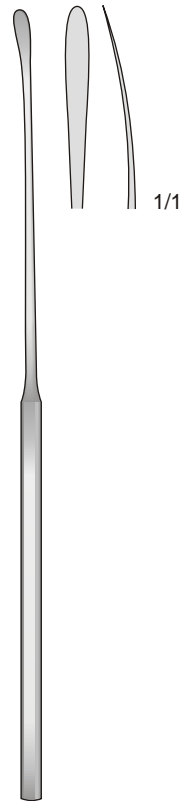

**SACHS  
KO-28**  
210 mm

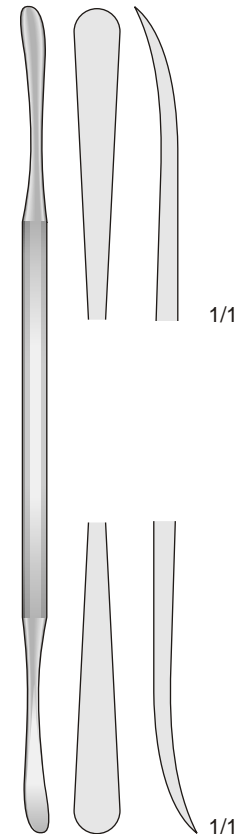

**KO-29**  
220 mm

Dissektoren  
Separatoren

Dissectors  
Seperators

Dissettori  
Separatori

Disecadores  
Descoladores

Dissecteurs  
Separateurs

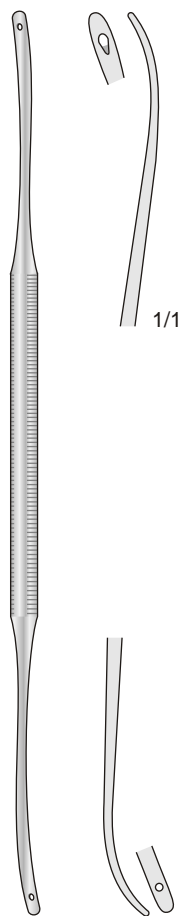

Fin  
Fein  
Fine  
Fino  
Fin

1/1

1/1

**KO-14** - 180 mm  
**KO-15** - 240 mm

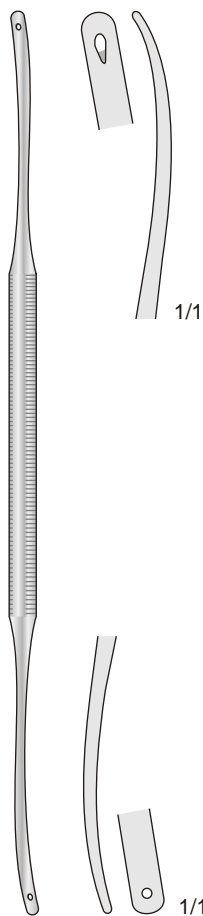

1/1

1/1

**KO-16** - 180 mm  
**KO-17** - 240 mm

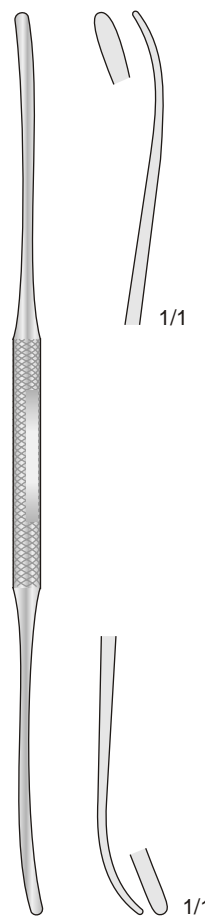

1/1

1/1

OLIVECRONA  
**KO-47** - 180mm  
**KO-48** - 240mm

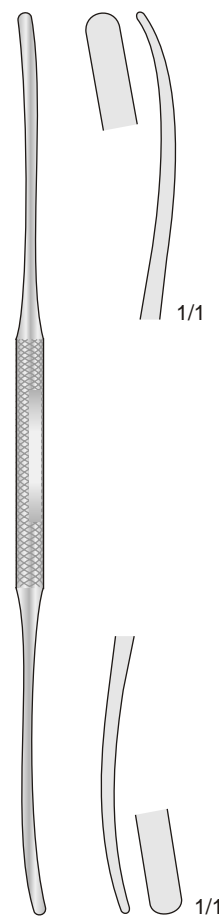

1/1

1/1

OLIVECRONA  
**KO-49** - 195mm  
**KO-50** - 240mm

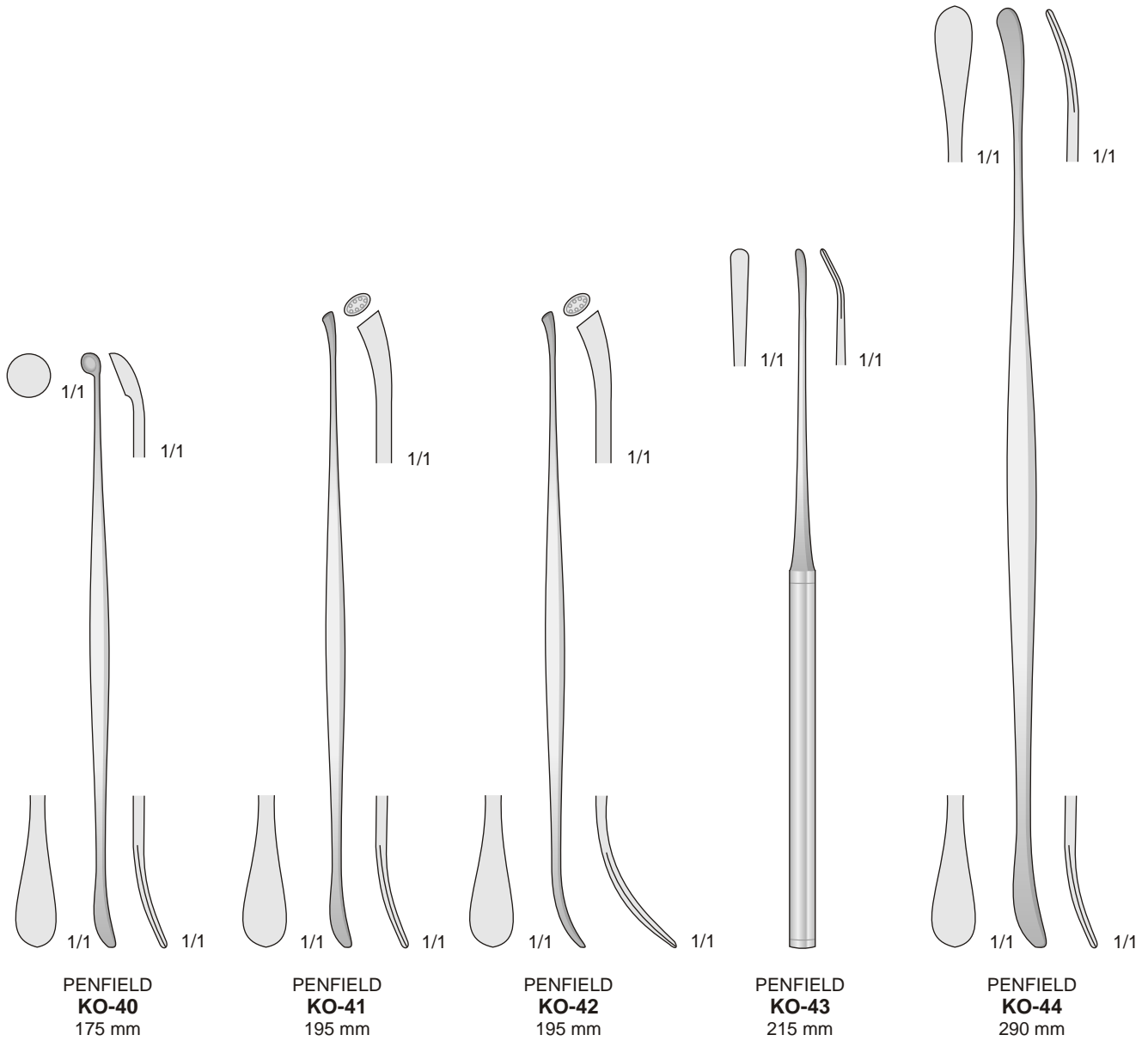

Raspatorien

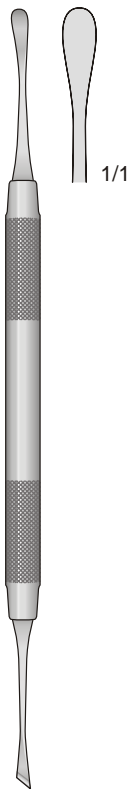

**718-24G**  
185 mm

Raspatories

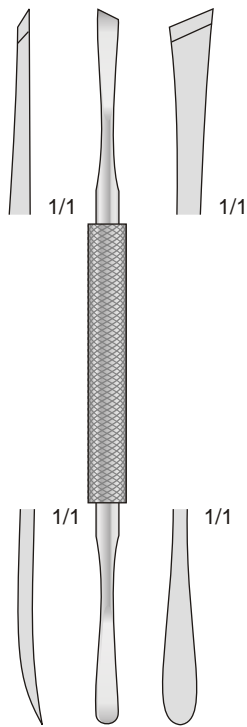

**MEAD**  
165 mm

Periostotomi

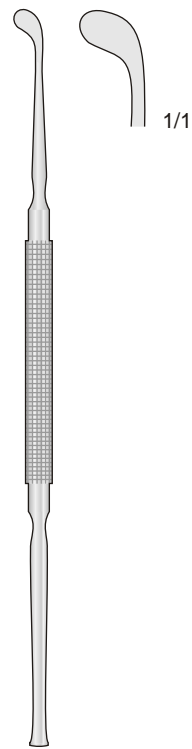

**FREER  
FR-15**  
190 mm

Legras

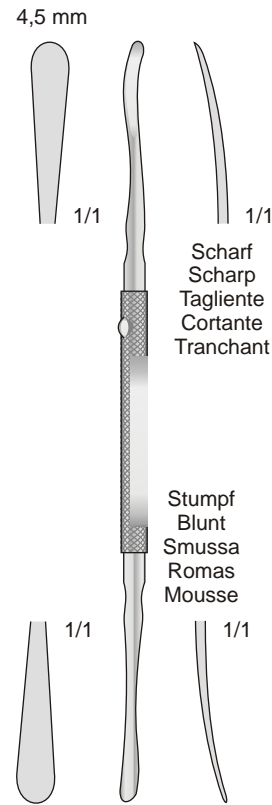

**FREER**  
180 mm

Rugines

Scharf  
Scharp  
Tagliente  
Cortante  
Tranchant

Stumpf  
Blunt  
Smussa  
Romas  
Mousse

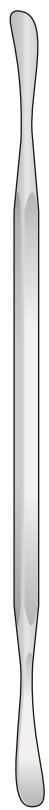

**ALDERDYCE  
KO-39**  
210 mm

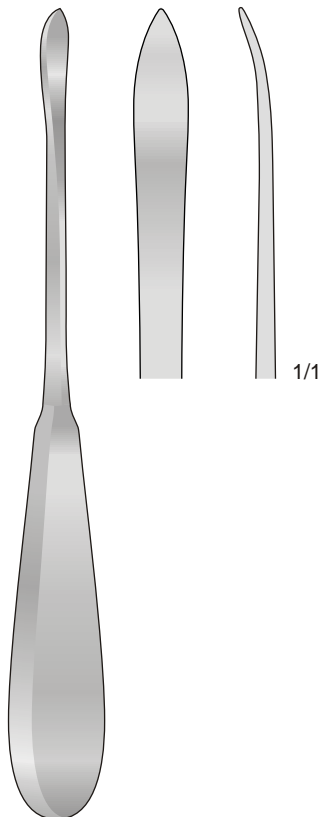

**LANGENBECK  
FK-12**  
200 mm

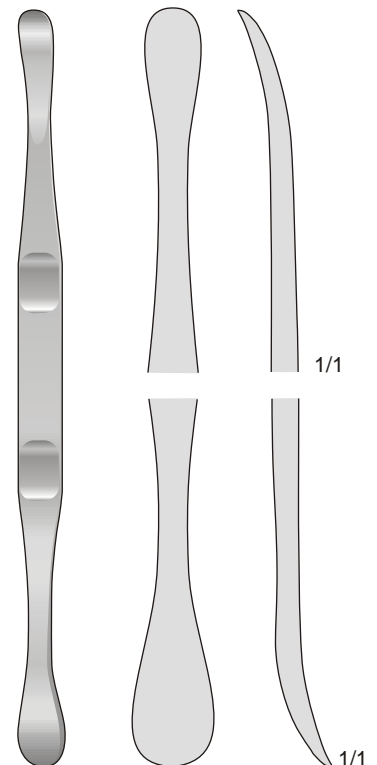

**BABBUSH  
KO-20**  
180 mm

Raspatorien

Raspatories

Periostotomi

Legras

Rugines

Septum Elevatorien  
 Periosteal Elevators  
 Elevatori per il setto nasale  
 Elevadores para el tabique nasal  
 Elévateurs pour cloison nasale

4 mm

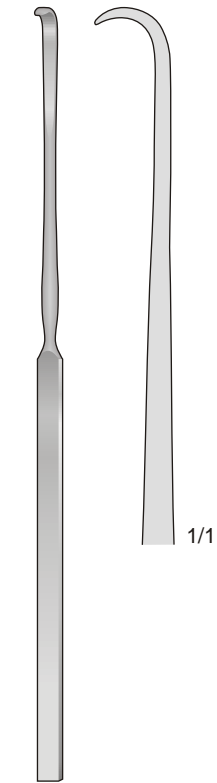

**DO-244**  
200 mm

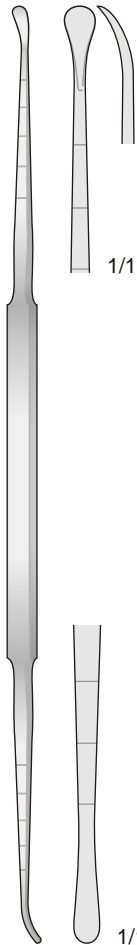

**COTTLE DO-60**  
220 mm

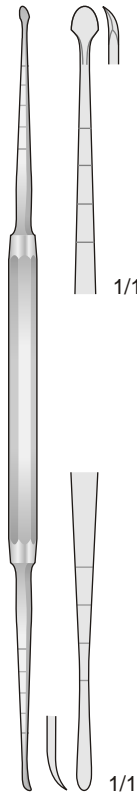

**MASING DO-47**  
210 mm

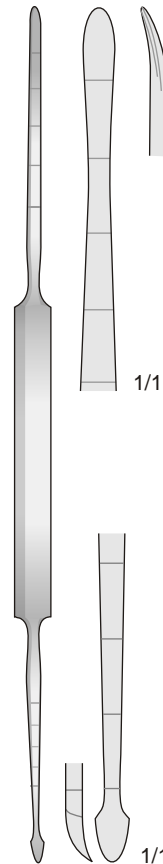

**COTTLE DO-111**  
210 mm

5 mm

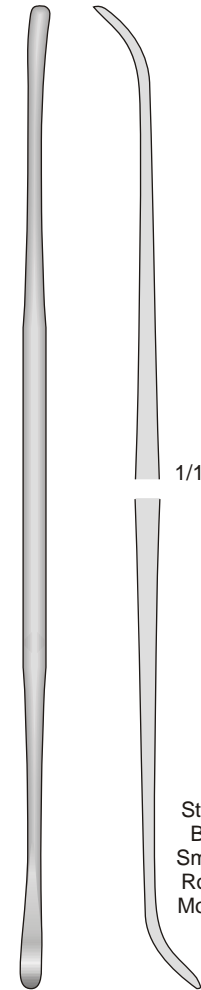

**SALZBURG DO-240**  
245 mm

5 mm

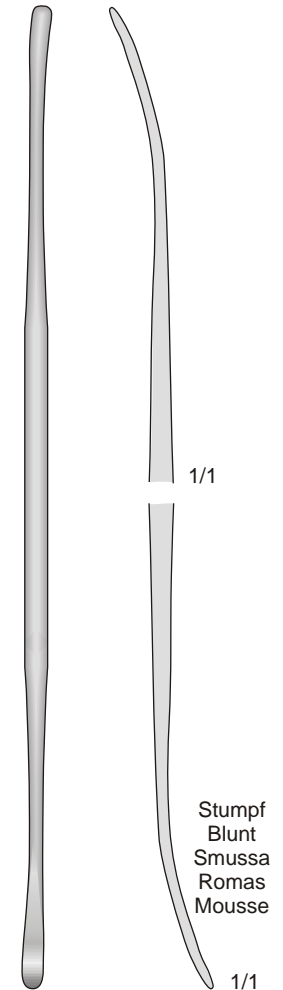

**SALZBURG DO-241**  
245 mm

Scharf  
 Sharp  
 Tagliente  
 Cortante  
 Tranchant

Scharf  
 Sharp  
 Tagliente  
 Cortante  
 Tranchant

Stumpf  
 Blunt  
 Smussa  
 Romas  
 Mousse

Stumpf  
 Blunt  
 Smussa  
 Romas  
 Mousse

Raspatorien

Raspatories

Periostotomi

Legras

Rugines

Septum Elevatorien - Periosteal Elevators - Elevatori per il setto nasale - Elevadores para el tabique nasal - Elévateurs pour cloison nasale

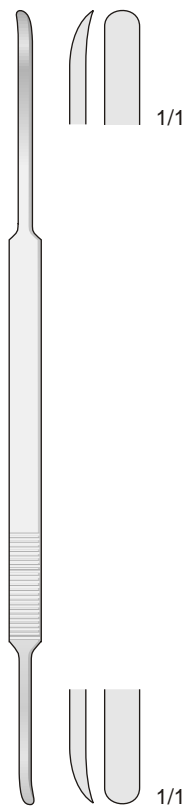

MCKENTY  
**KO-46**  
220 mm



BALLENGER-HAYEK  
**KO-61** 190 mm  
**KO-62** 220 mm

Scharf/Stumpf  
Sharp/Blunt  
Tagliente/Smusso  
Cortante/Romo  
Tranchant/Mousse

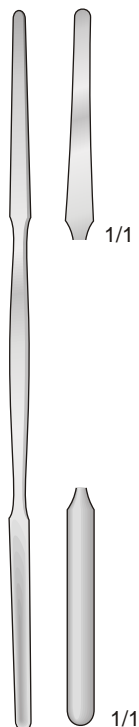

KILLIAN  
**KO-63**  
180 mm

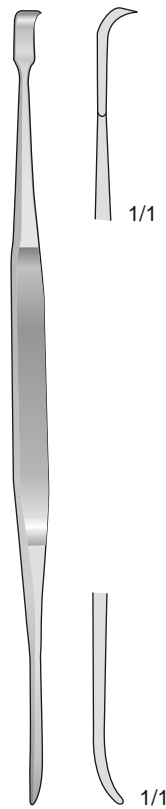

HOWARTH  
**KO-30**  
210 mm

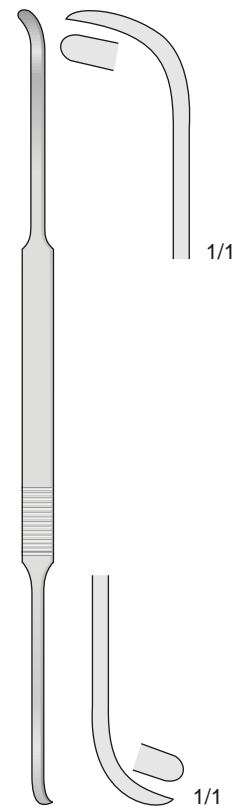

COTTLE  
**KO-12**  
230 mm

Scharf/Stumpf - Sharp/Blunt  
Tagliente/Smusso - Cortante/Romo  
Tranchant/Mousse

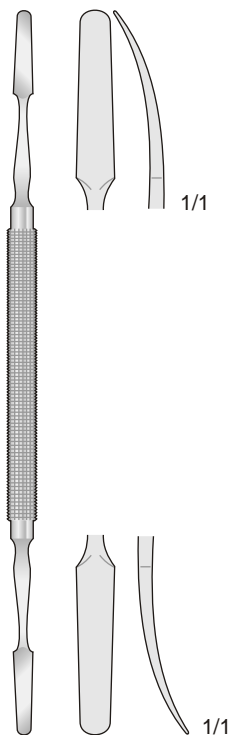

KILLIAN  
**KO-11**  
180 mm

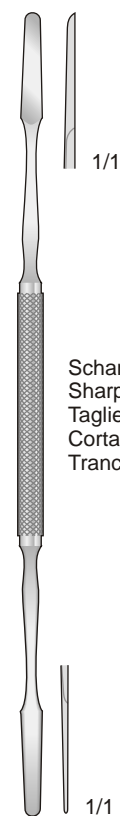

KILLIAN  
**KO-13**  
220 mm

Scharf/Stumpf  
Sharp/Blunt  
Tagliente/Smusso  
Cortante/Romo  
Tranchant/Mousse

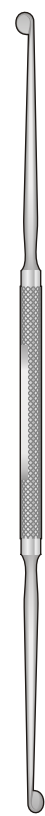

PIERCE  
**KO-64**  
210 mm

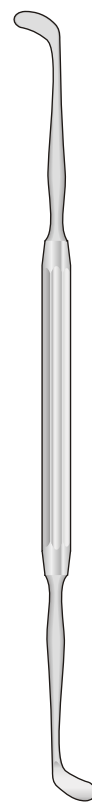

PENNINGTON  
**KO-65**  
210 mm

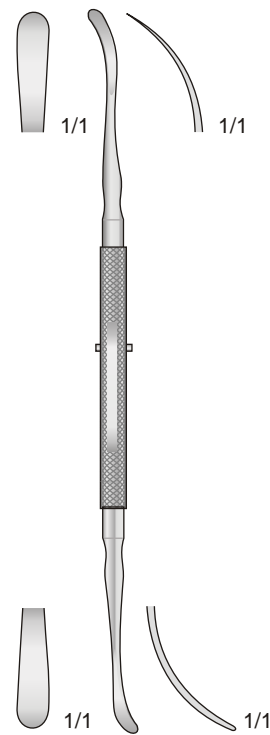

ROGER  
**KO-66**  
180 mm

Raspatorien

Raspatories

Periostotomi

Legras

Rugines

Raspatorien, Elevatorien, Flachmeißel - Raspatories, Elevators, Chisels

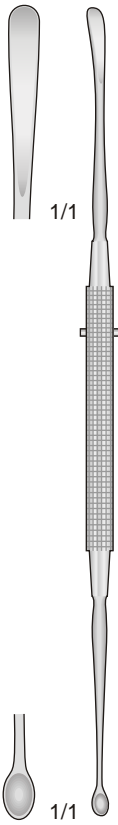

**CARTER  
KO-67**  
210 mm

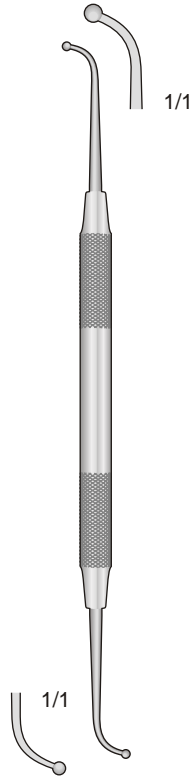

**712-18**  
180 mm

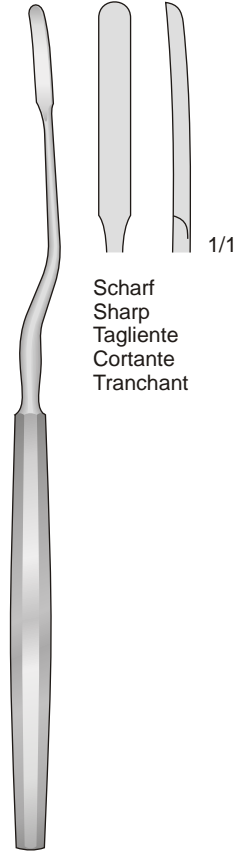

**MASING  
KO-68**  
220 mm

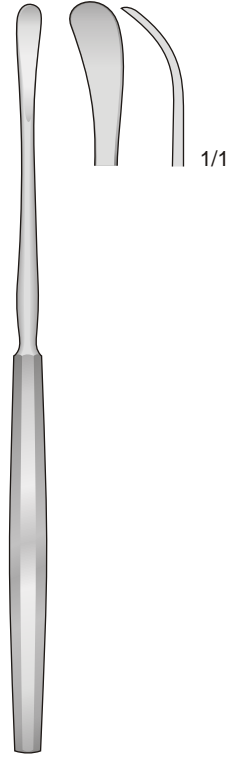

**SEWALL  
KO-69**  
200 mm

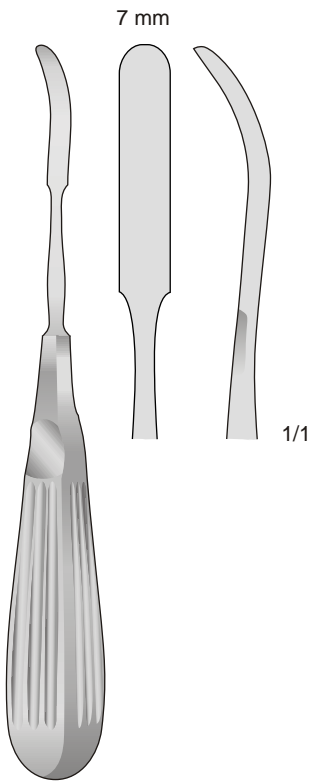

**JOSEPH  
FK-82**  
180 mm

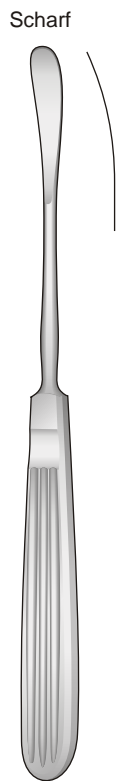

**COTTLE  
DO-211**  
180 mm

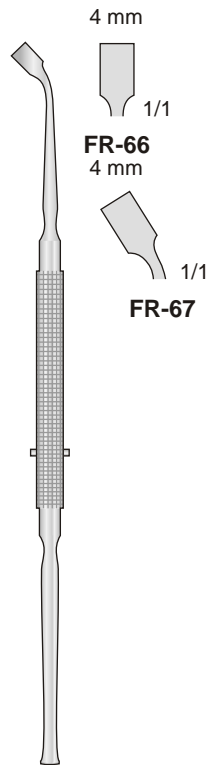

**FREER  
FR-66/FR-67**  
190 mm

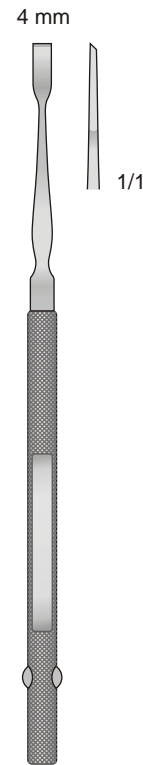

**TG-11**  
160 mm

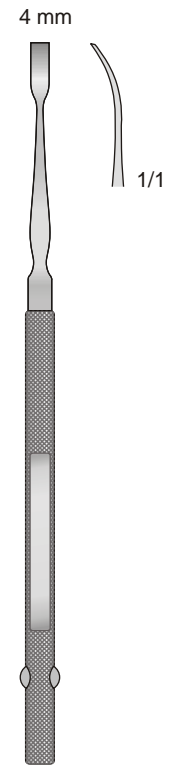

**FREER  
TG-23**  
160 mm



Raspatorien

Raspatories

Periostotomi

Legras

Rugines

Septum Elevatorien - Periosteal Elevators - Elevatori per il setto nasale  
Elevadores para el tabique nasal - Elévateurs pour cloison nasale

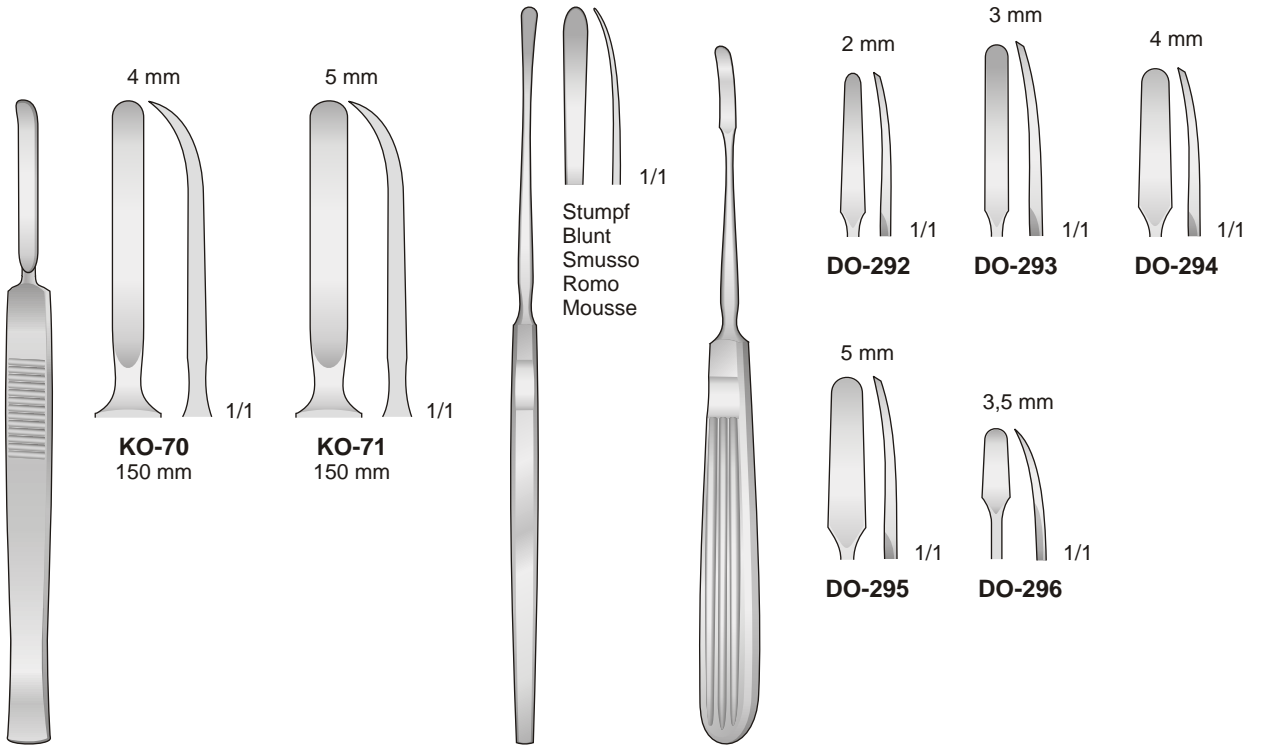

Mc KENTY  
**KO-70/KO-71**  
150 mm

**KO-72**  
180 mm

WALTON  
**DO-292/DO-296**  
160 mm

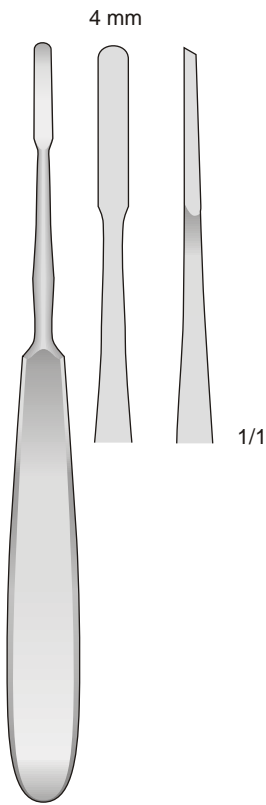

FOMON  
**FK-264**  
170 mm

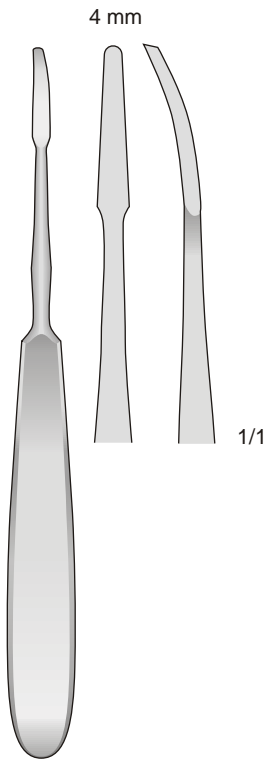

JOSEPH  
**FK-265**  
160 mm

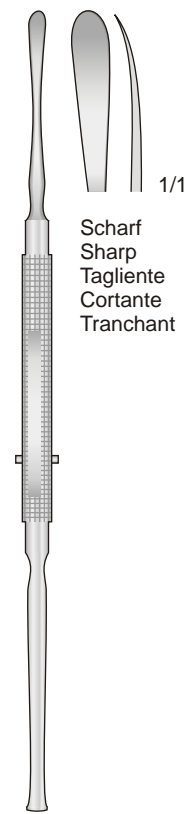

FREER  
**FR-64**  
190 mm

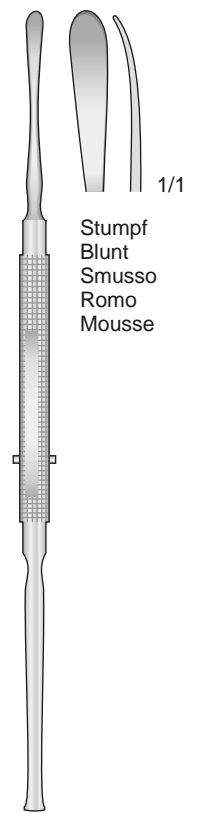

FREER  
**FR-65**  
190 mm

Raspatorien - Scharf  
 Raspatories - Sharp  
 Periostotomi - Taglienti  
 Legras - Cortante  
 Rugines - Tranchant

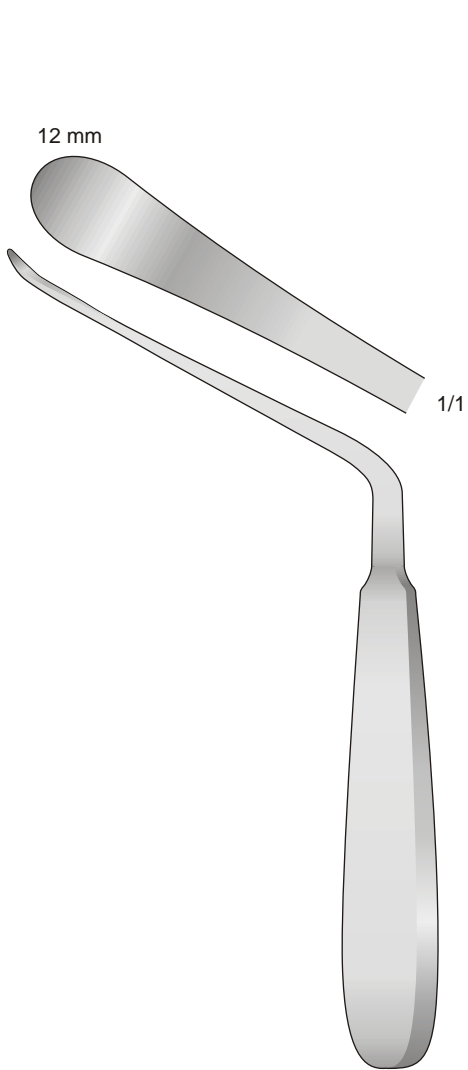

**DO-125**  
210 mm

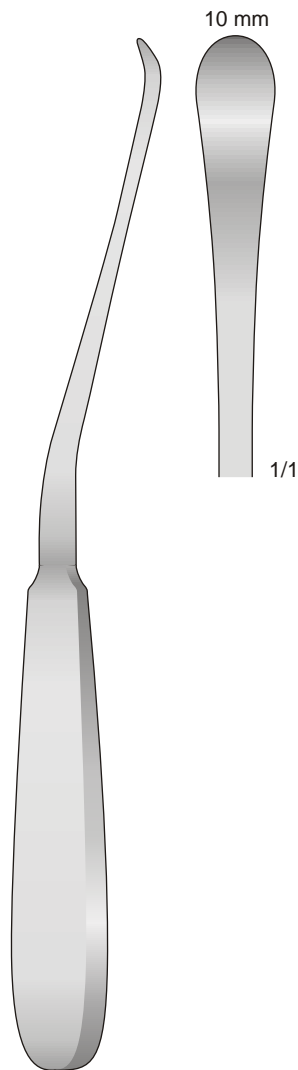

**DO-126**  
235 mm

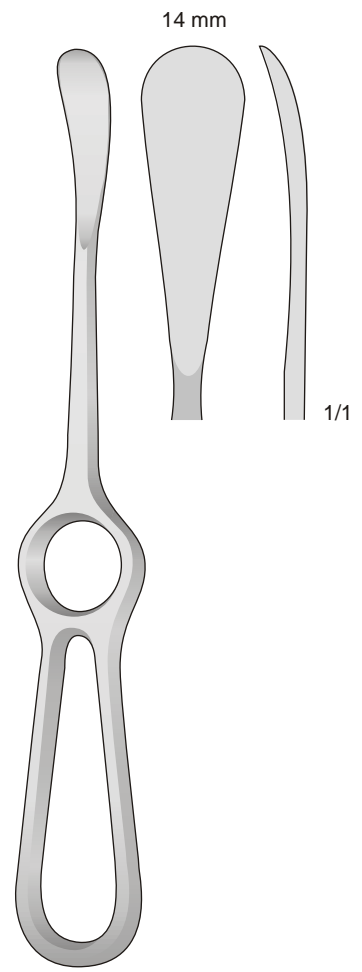

**SEDILLOT**  
**BT-37**  
210 mm

Raspatorien

Raspatories

Periostotomi

Legras

Rugines

Periosteal elevators

Scharf  
Sharp  
Taglienti  
Cortante  
Tranchant

6 mm

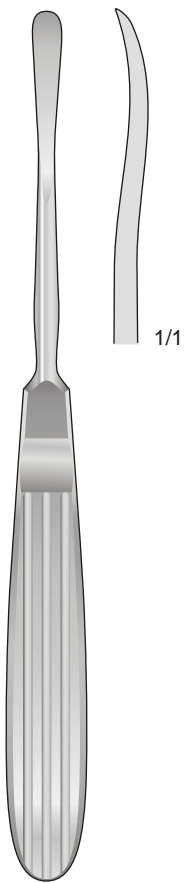

OBWEGESER  
**DO-59**  
175 mm

7 mm

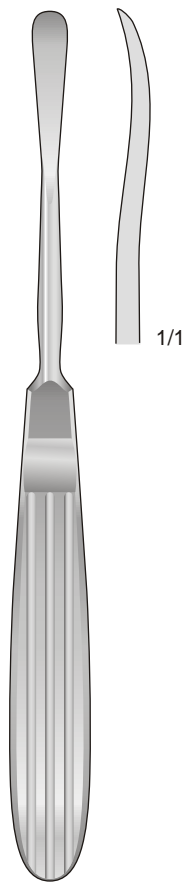

OBWEGESER  
**DO-63**  
175 mm

9 mm

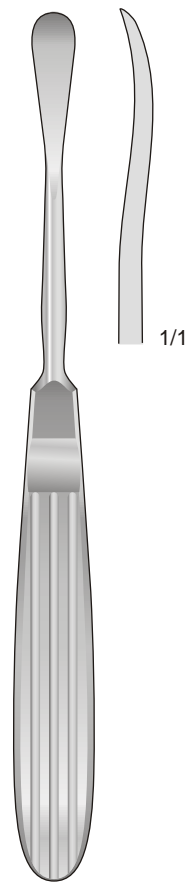

OBWEGESER  
**DO-67**  
175 mm

11 mm

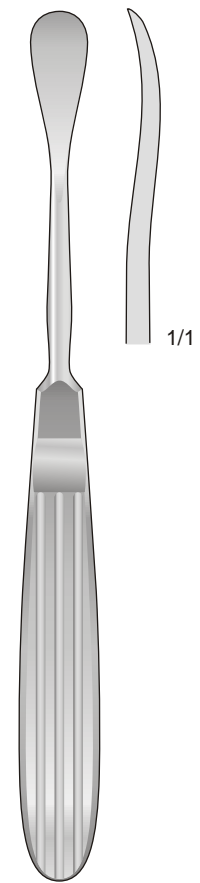

OBWEGESER  
**DO-65**  
175 mm

Raspatorien, Elevatorien  
Raspatories, Elevators

Massiv - Solid - Manico pieno - Massif

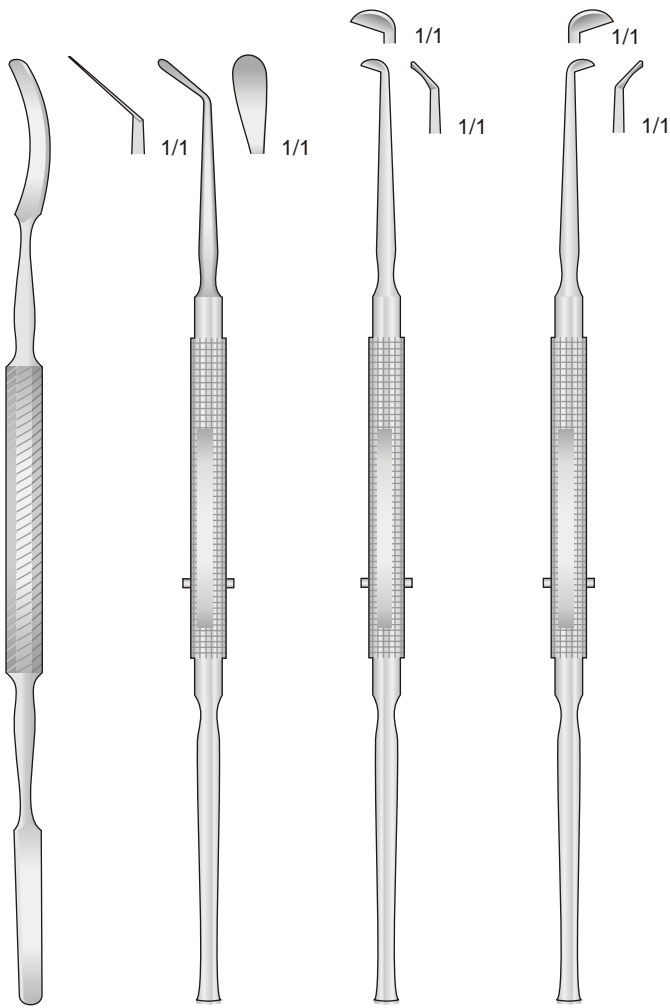

**MC DONALD  
KO-38**  
190 mm

**FREER  
FR-100**

**FREER  
FR-166**

**FREER  
FR-167**



**CH-11**  
150 mm



**CH-12**  
150 mm



**CH-13**  
150 mm



**CH-14**  
145 mm

Raspatorien

Periosteal Raspatories

Periostotomi - Raspatori

Periostotomos - Legras

Rugines à périostomie

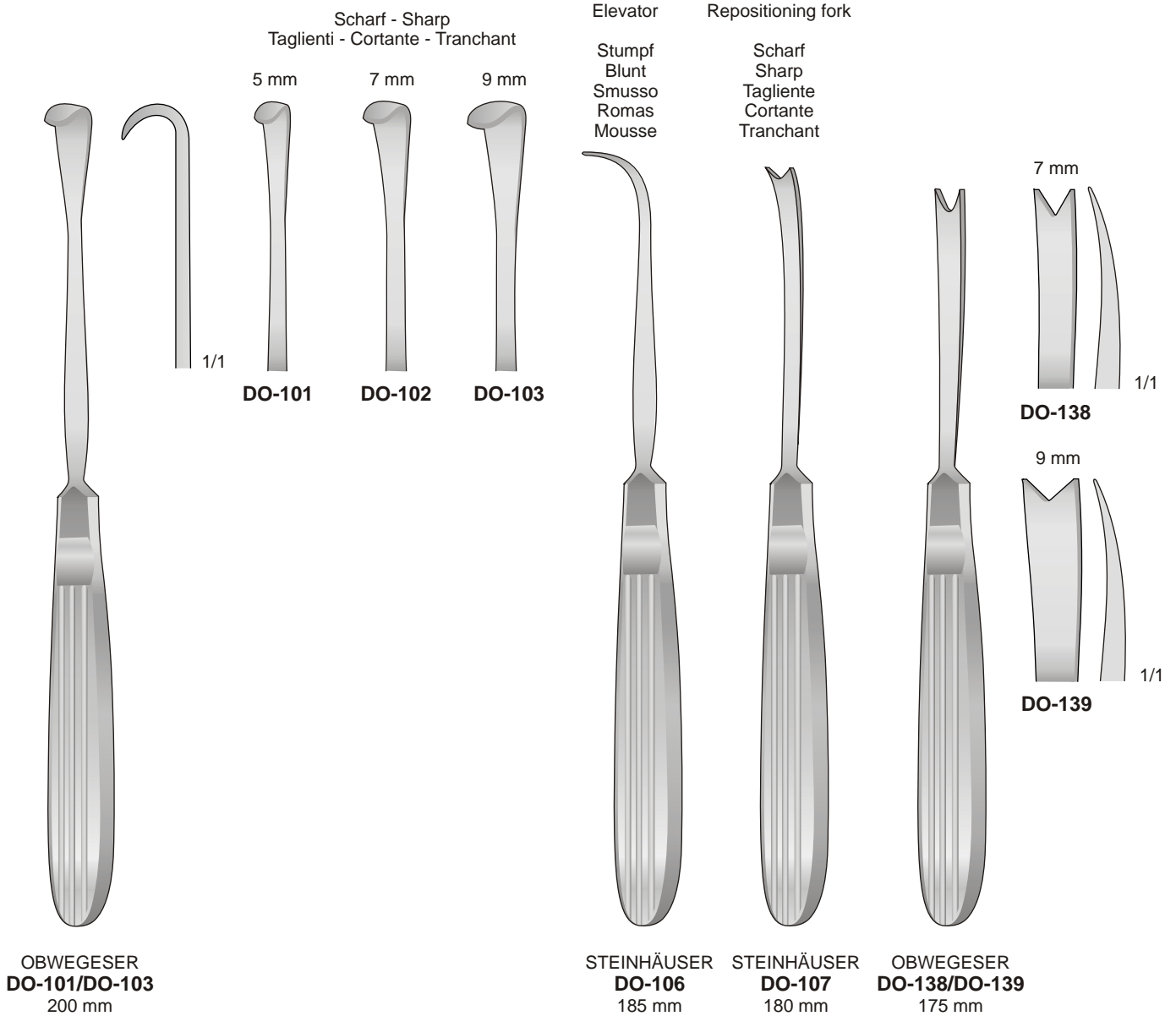

Raspatorien

Periosteal Raspatories

Periostotomi - Raspatori

Periostotomos - Legras

Rugines à périostomie

15 mm

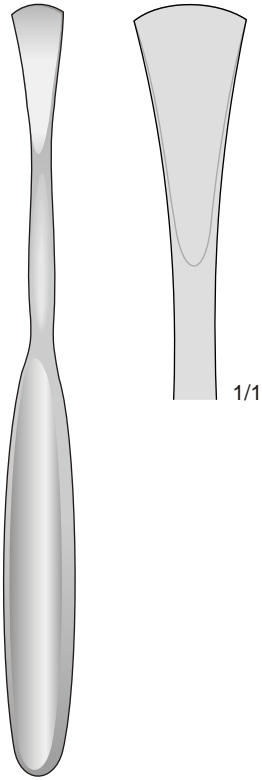

**CUSHING  
FK-252  
190 mm**

8 mm

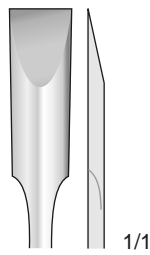

**FK-260**

7 mm

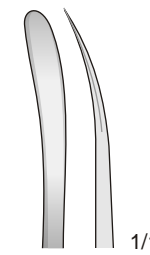

**FK-261**

7 mm

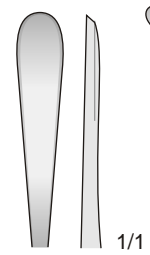

**FK-262**

7 mm

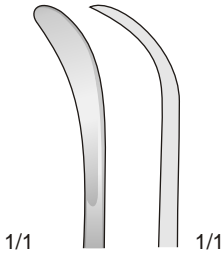

**FK-263**



**ADSON  
FK-260/FK-263  
170 mm**

2,5 mm

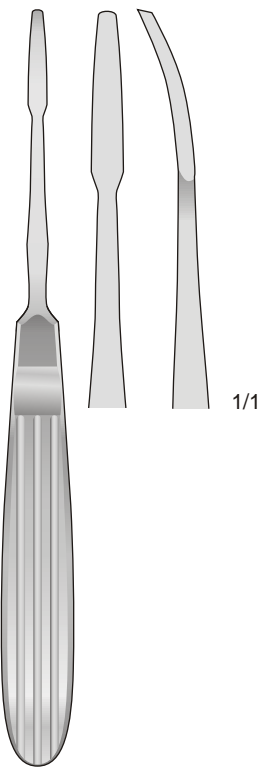

**JOSEPH  
FK-80  
170 mm**

7 mm

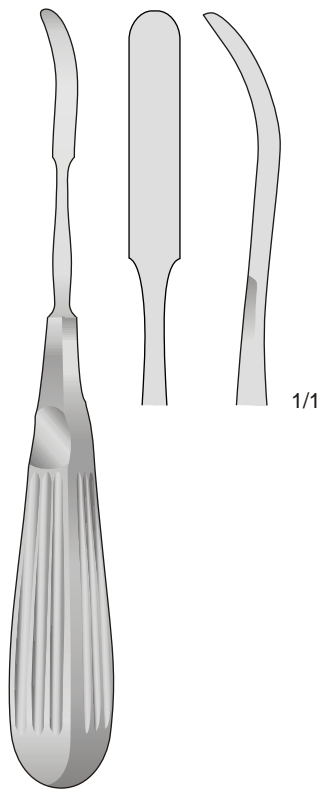

**JOSEPH  
FK-82  
180 mm**

10 mm



**MOLT  
MO-15  
160 mm**

10 mm

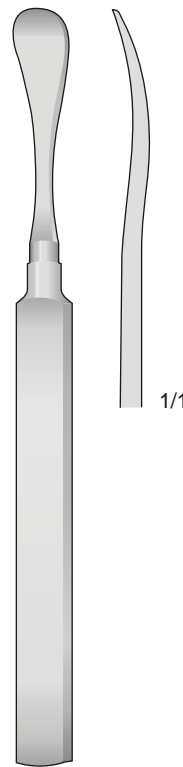

**HENAHAN  
BT-05/BT-07  
175 mm**

12 mm



**BT-05**

15 mm

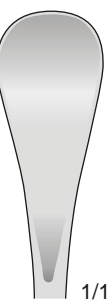

**BT-07**

Raspatorien

Periosteal Raspatories

Periostotomi - Raspatori

Periostotomos - Legras

Rugines à périostomie

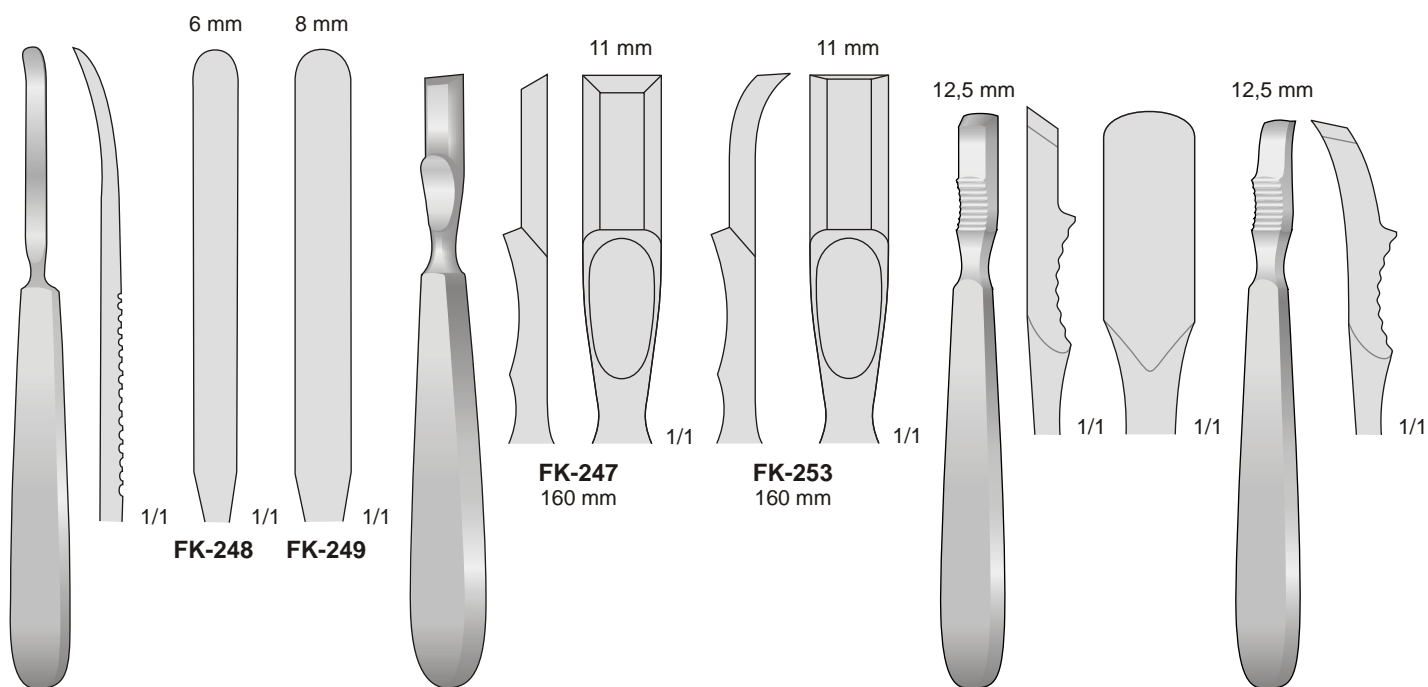

**FK-248/FK-249**  
170 mm

**FARABEUF-COLLIN**  
**FK-247/FK-253**  
160 mm

**FARABEUF**  
**FK-250**  
150 mm

**FARABEUF**  
**FK-251**  
150 mm

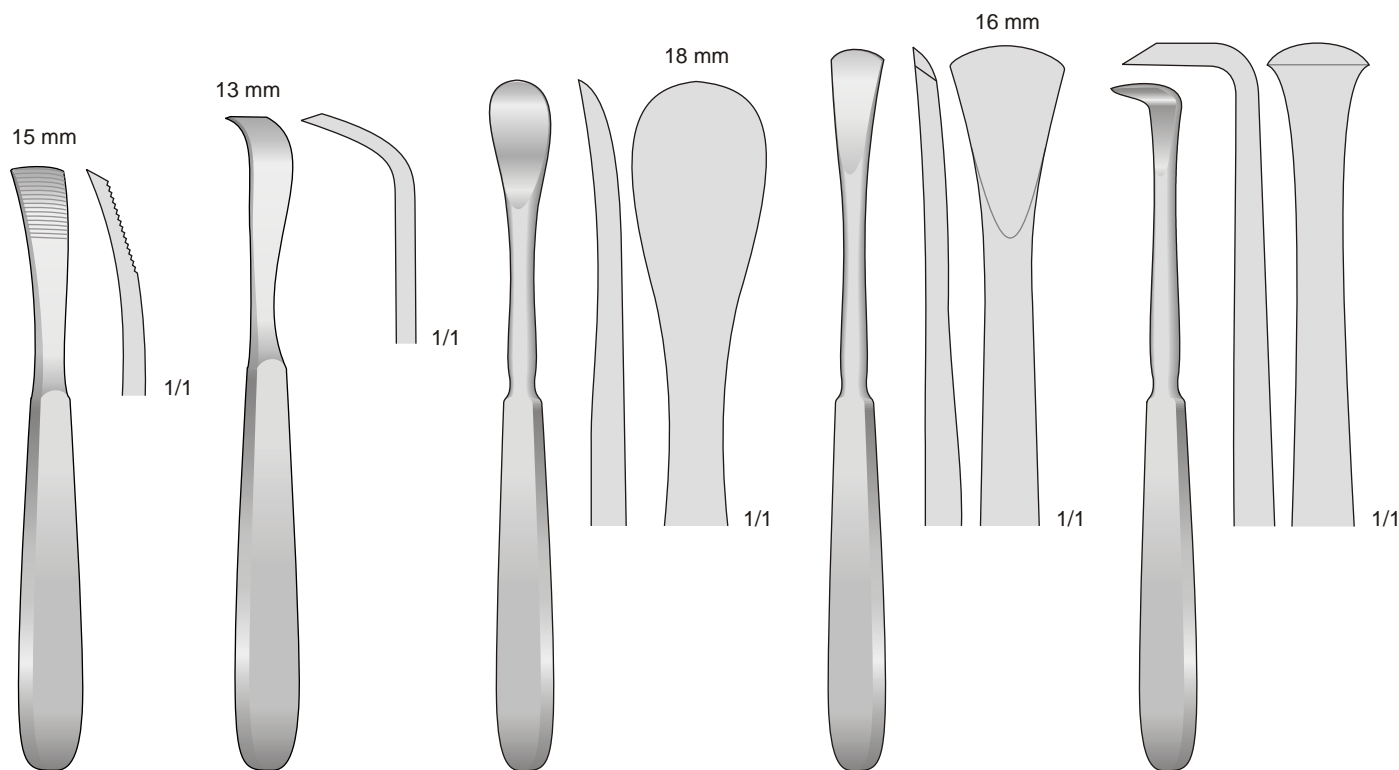

**JANSEN**  
**FK-255**  
165 mm

**SCHNEIDER**  
**FK-258**  
175 mm

**SEDILLOT**  
**FK-254**  
185 mm

**LANGENBECK**  
**FK-256**  
190 mm

**LANGENBECK**  
**FK-257**  
180 mm







SADIQ SURGICAL CO.

Catalogue 2015 / 2016



8

Knochenmeissel, Hämmer  
Bone Chisels, Hammers  
Scalpelli, Martelli  
Cinceles, Martillos  
Scalpel, Maillets



Osteotome

Osteotomes

Osteotomi

Osteòtomos

Ostèotomes

Septummeißel  
 Septum Chisels  
 Scalpelli per il setto nasale  
 Cinceles para tabique nasal  
 Ciseaux-Burins pour la cloison nasale

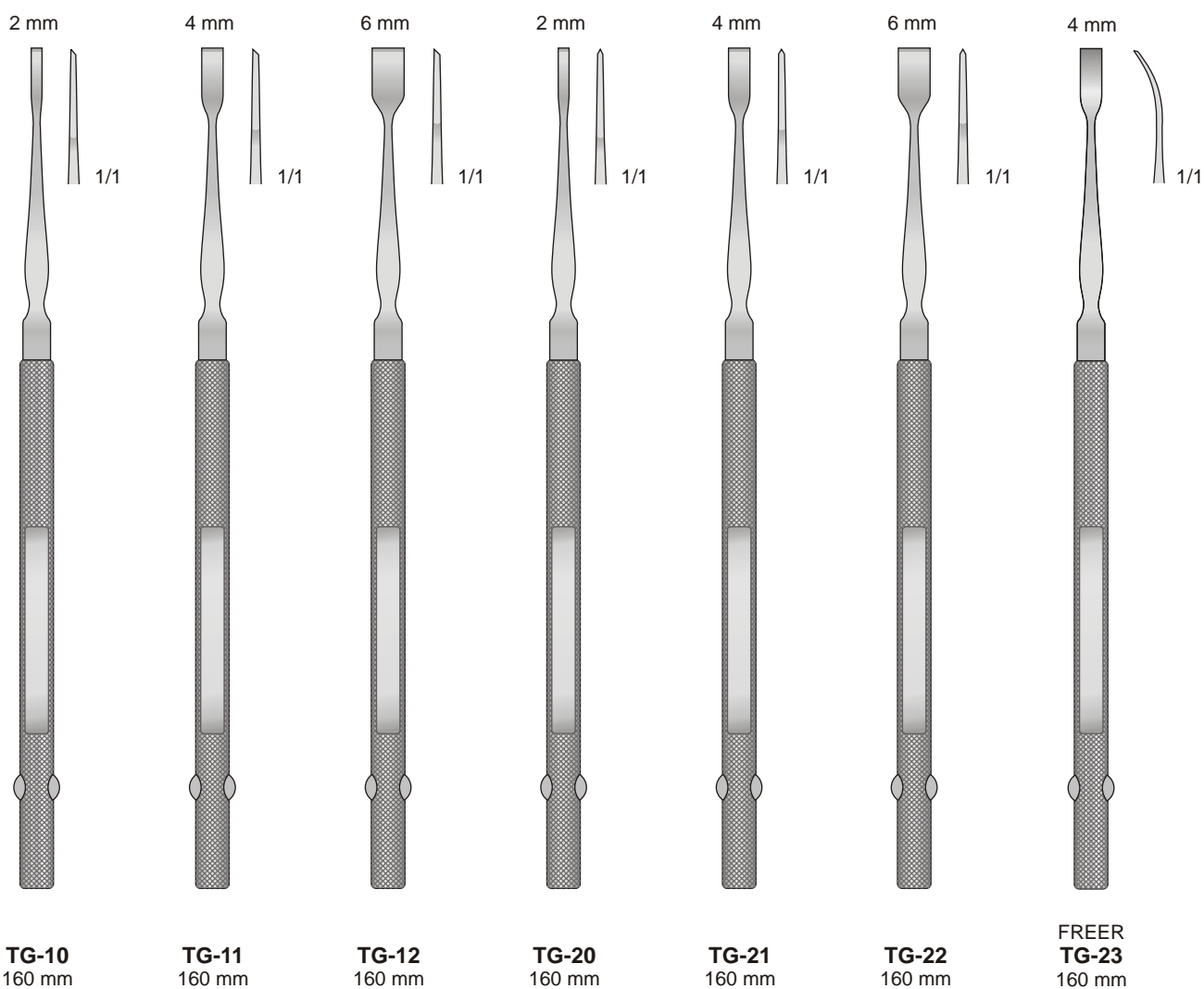

Osteotome

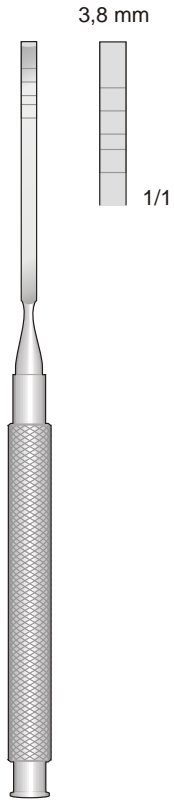

**FL-141**  
170 mm

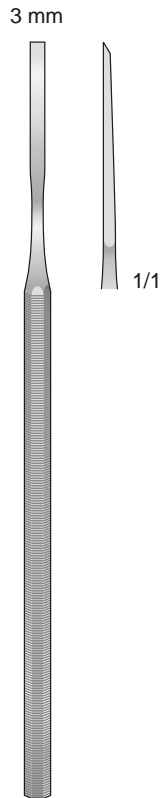

**TG-30**  
155 mm

Osteotomes

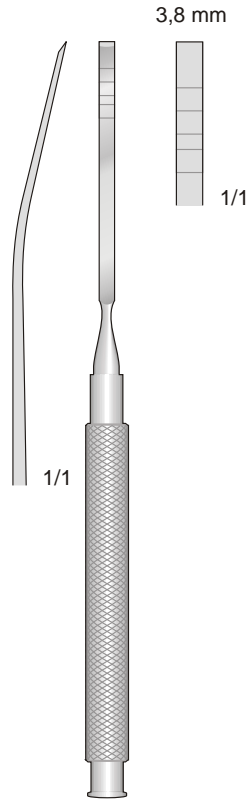

**FL-142**  
170 mm

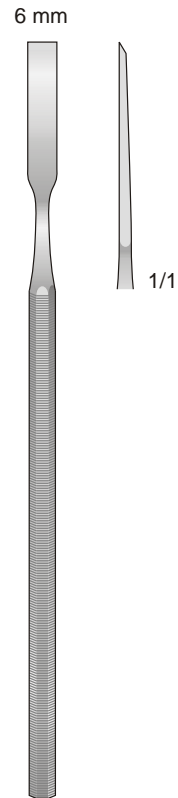

**TG-31**  
155 mm

Osteotomi

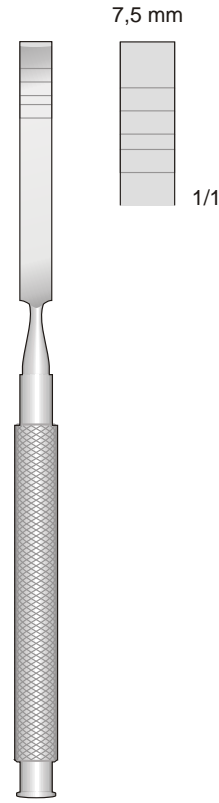

**FL-143**  
170 mm

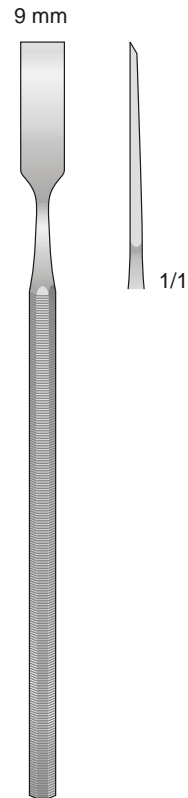

**TG-32**  
155 mm

Osteòtomos

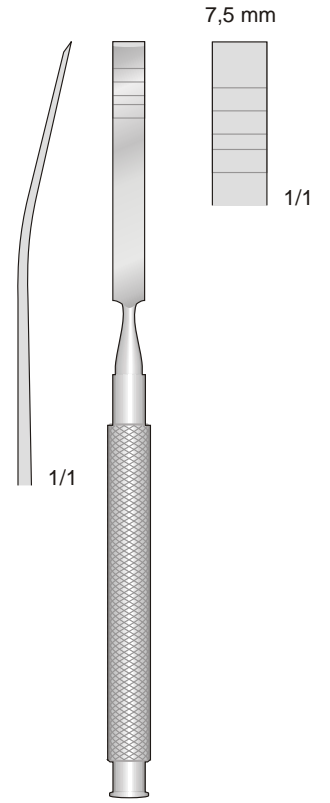

**FL-144**  
170 mm

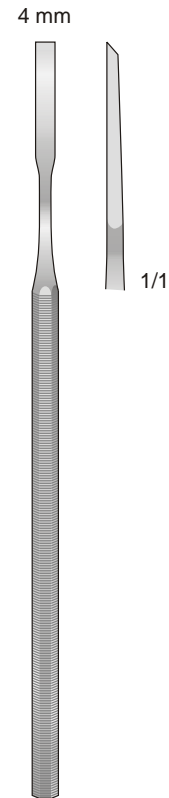

**BUCKLEY**  
**TG-40**  
160 mm

Ostèotomes

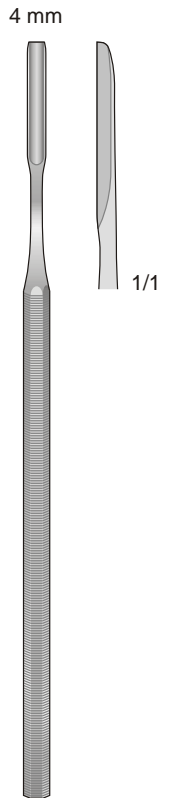

**BUCKLEY**  
**TG-41**  
160 mm

Osteotome

Osteotomes

Osteotomi

Osteòtomos

Ostèotomes

Septum-Hohlmeißel  
 Septum Gouges  
 Sgorbie per il setto nasale  
 Gubias para el tabique nasal  
 Gouges pour la cloison nasale

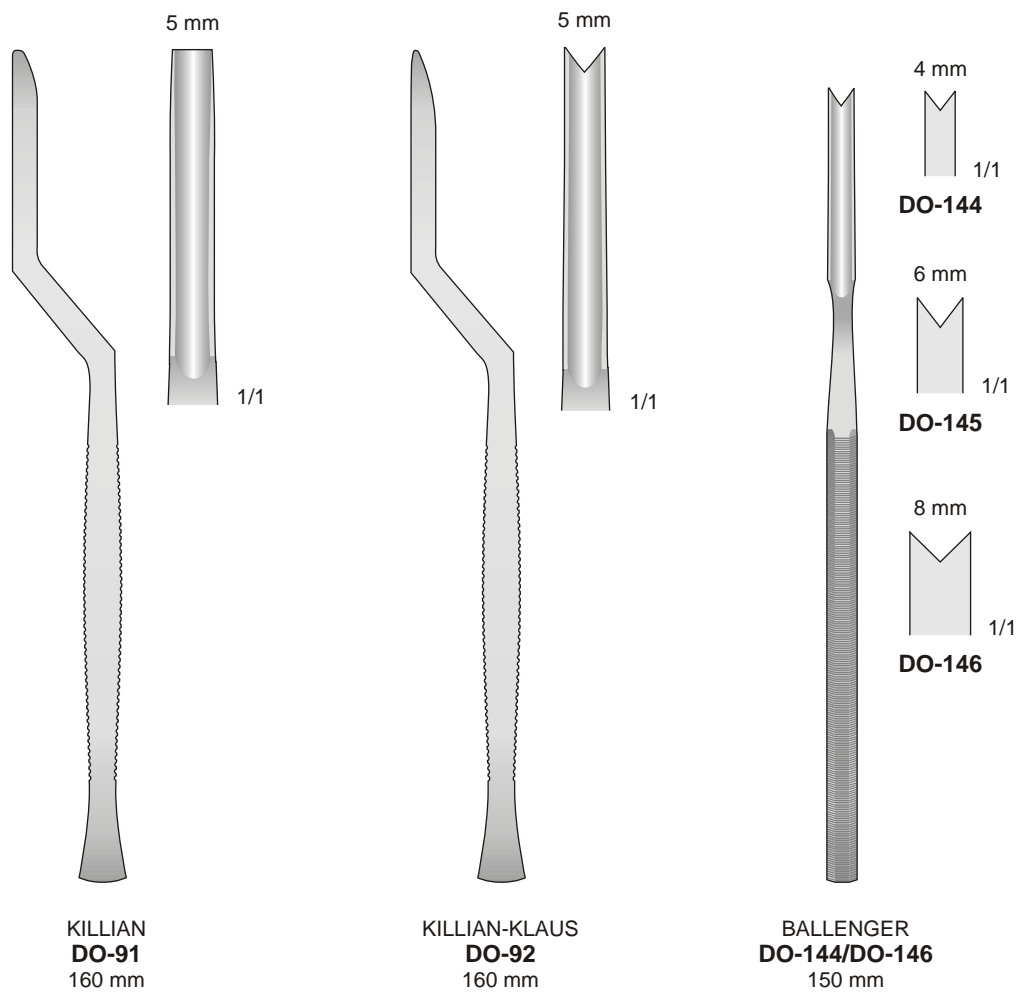

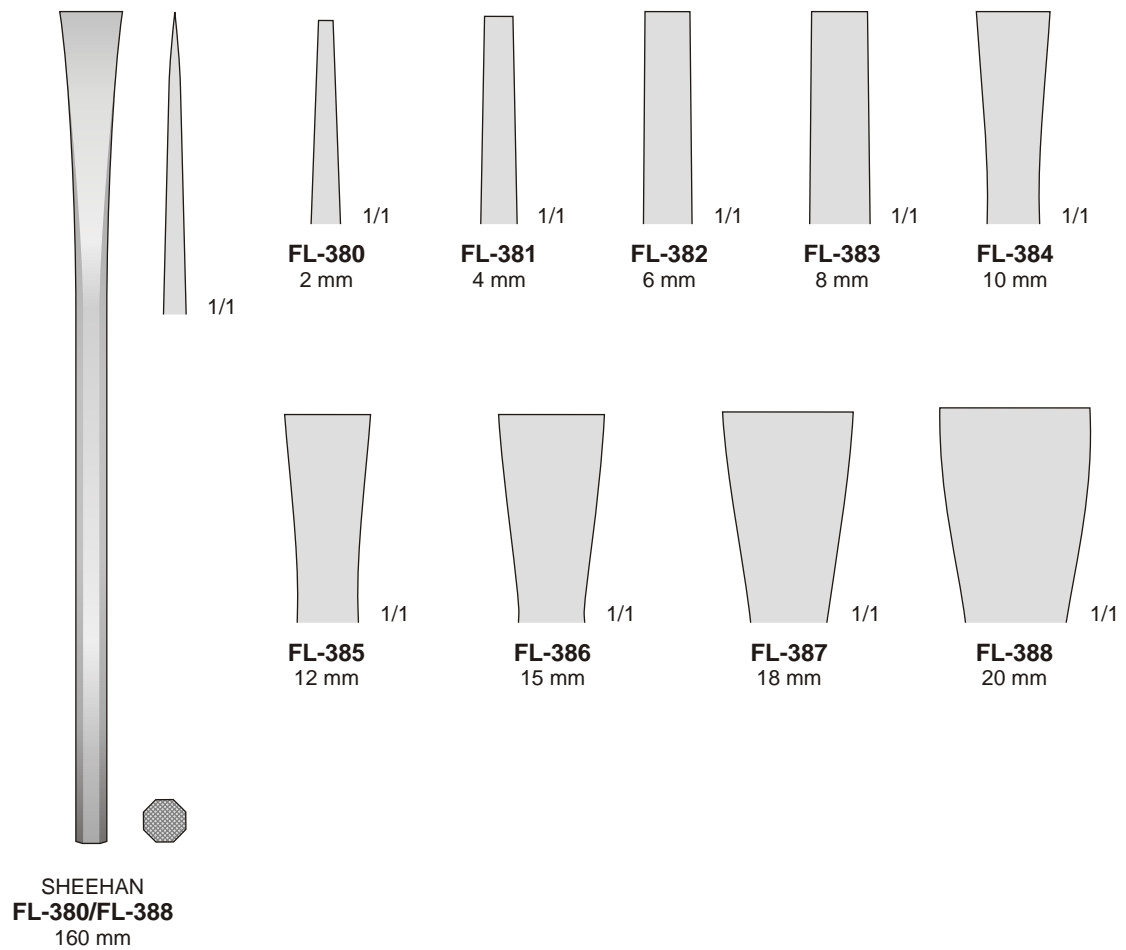

Osteotome-Hohlmeissel

Osteotomes - Gouges

Osteotomi - Scalpelli

Osteótomos - Cinceles

Ostéotomes - Scalpel

Osteotome -Osteotomes  
Osteotomi - Osteótomos - Ostéotomes

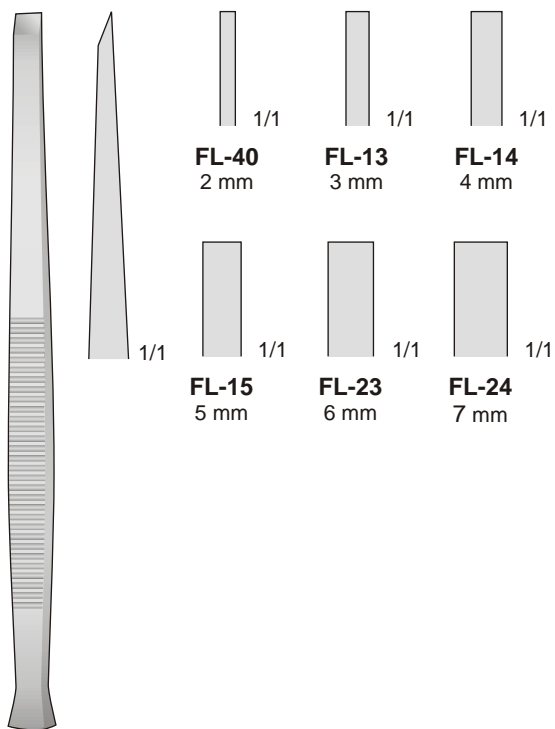

PARTSCH  
**FL-13/FL-40**  
140 mm

Hohlmeissel - Gouges  
Sgorbie - Gubias - Gouges

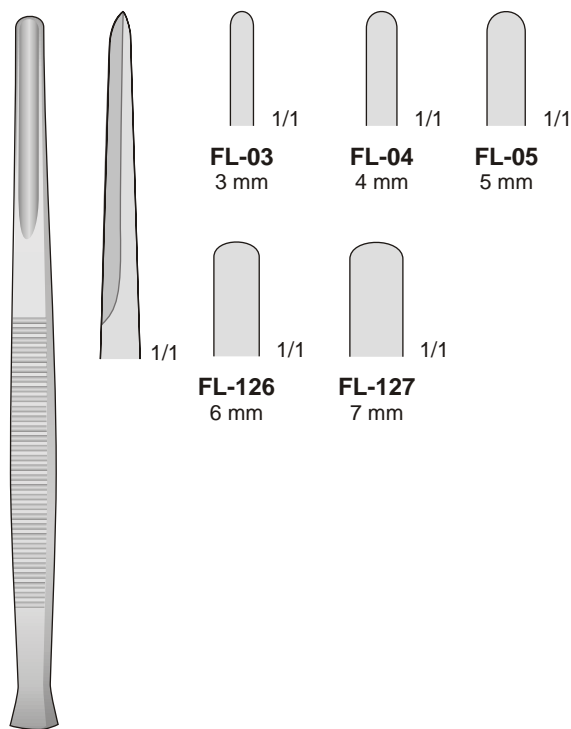

PARTSCH  
**FL-03/FL-127**  
140 mm

Osteotome -Osteotomes  
Osteotomi - Osteótomos - Ostéotomes

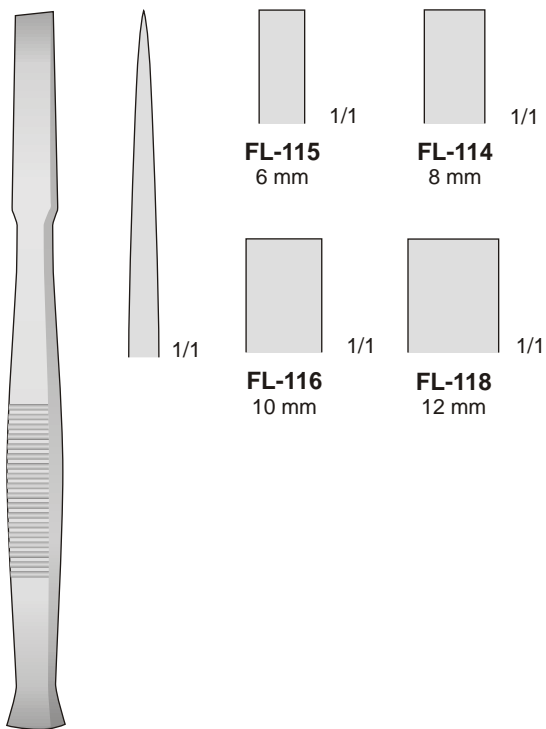

**FL-114/FL-118**  
140 mm

Hohlmeissel - Gouges  
Sgorbie - Gubias - Gouges

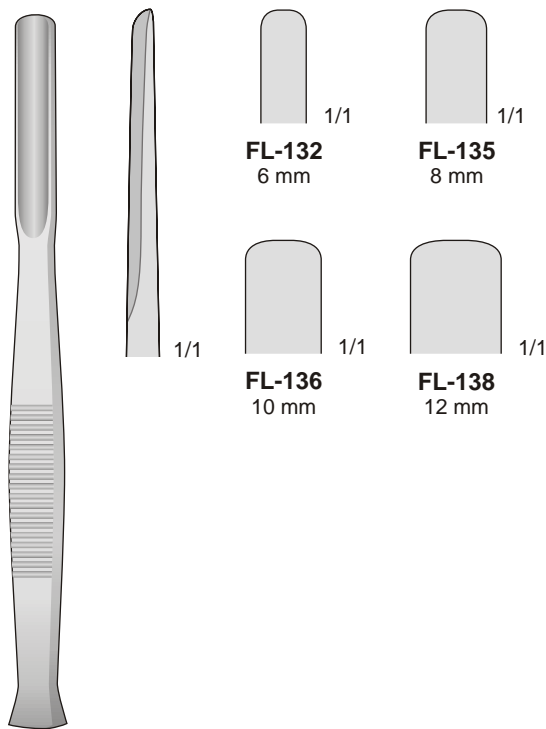

**FL-132/FL-138**  
140 mm

Flachmeißel



WEST  
**FL-133**  
160 mm

Hohlmeißel



WEST  
**FL-134**  
160 mm



PARTSCH  
**FL-177/FL-181**  
170 mm

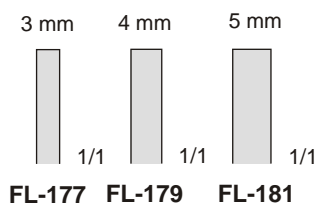

PARTSCH  
**FL-185/FL-187**  
170 mm

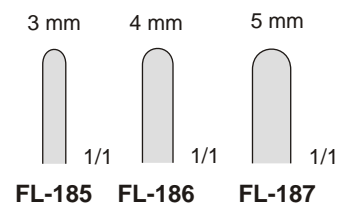
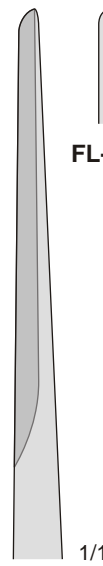



Osteotome

Osteotomes

Osteotomi

Osteòtomos

Ostèotomes

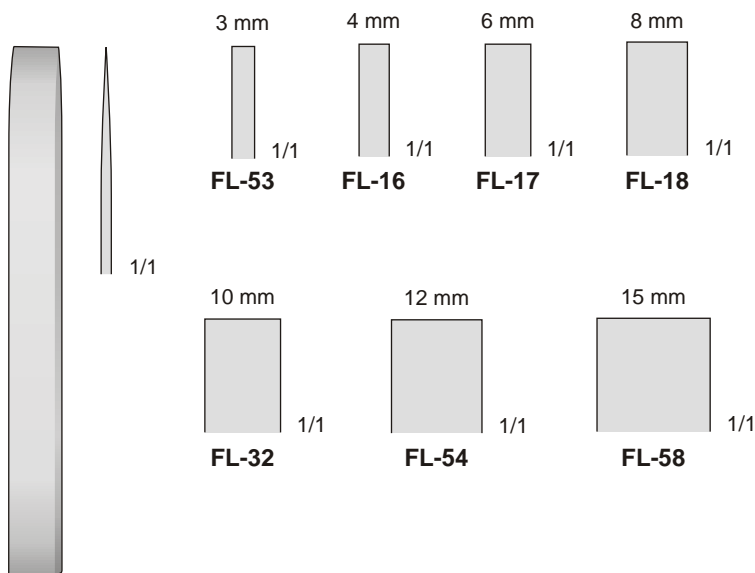

MINI-LAMBOTTE  
**FL-16/FL-58**  
 125 mm

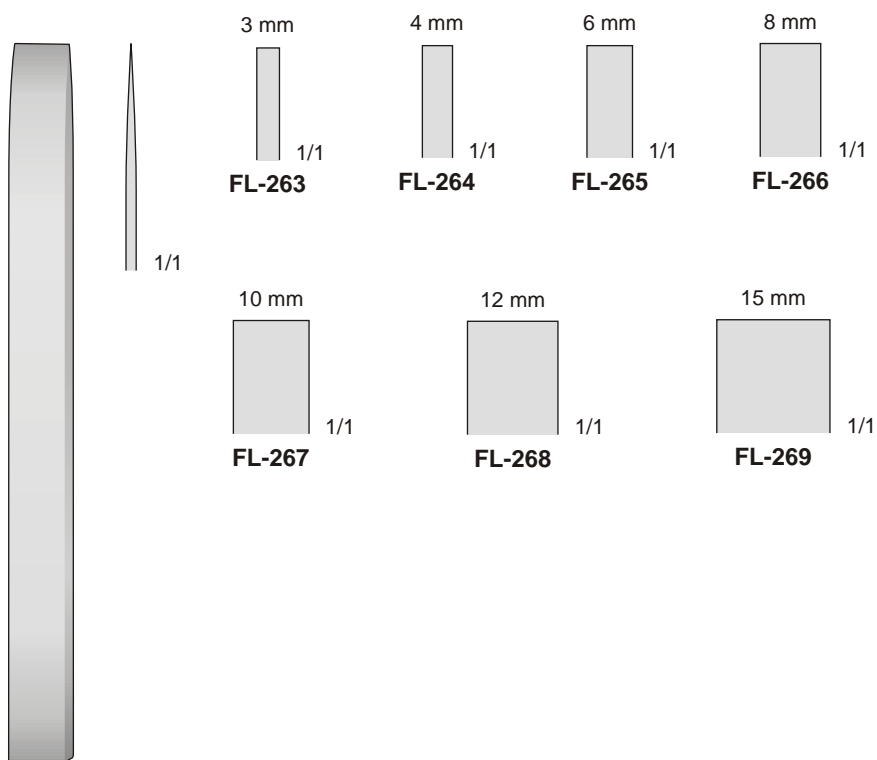

MINI-LAMBOTTE  
**FL-263/FL-269**  
 170 mm

Osteotome

Osteotomes

Osteotomi

Osteòtomos

Ostèotomes

4 mm

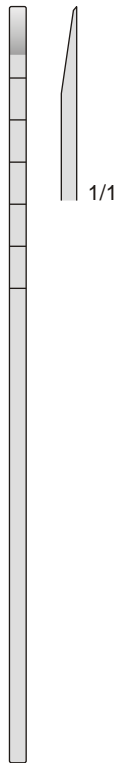

**COTTLE DO-130**  
180 mm

7 mm

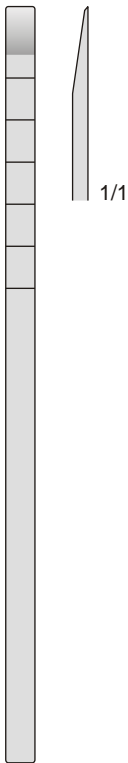

**COTTLE DO-131**  
180 mm

9 mm

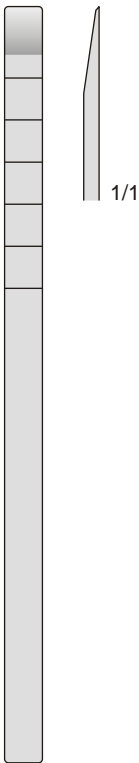

**COTTLE DO-132**  
180 mm

12 mm

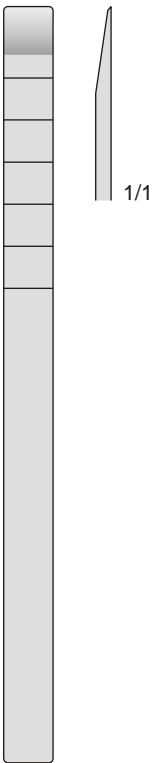

**COTTLE DO-133**  
180 mm

4 mm

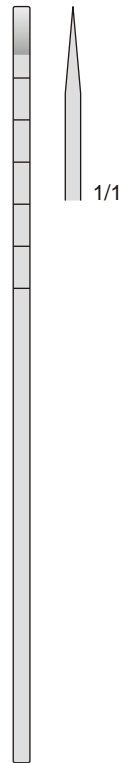

**COTTLE DO-140**  
180 mm

7 mm

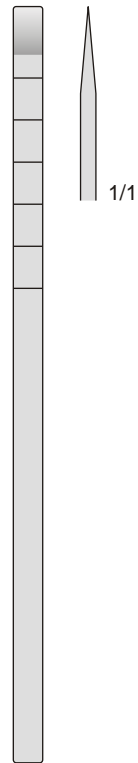

**COTTLE DO-141**  
180 mm

12 mm

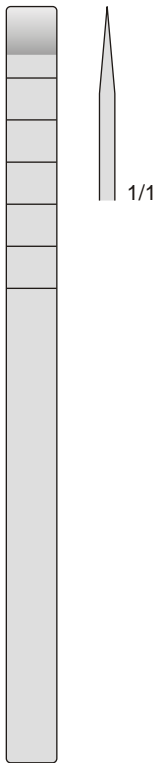

**COTTLE DO-143**  
180 mm

Osteotome

Osteotomes

Osteotomi

Osteòtomos

Ostèotomes

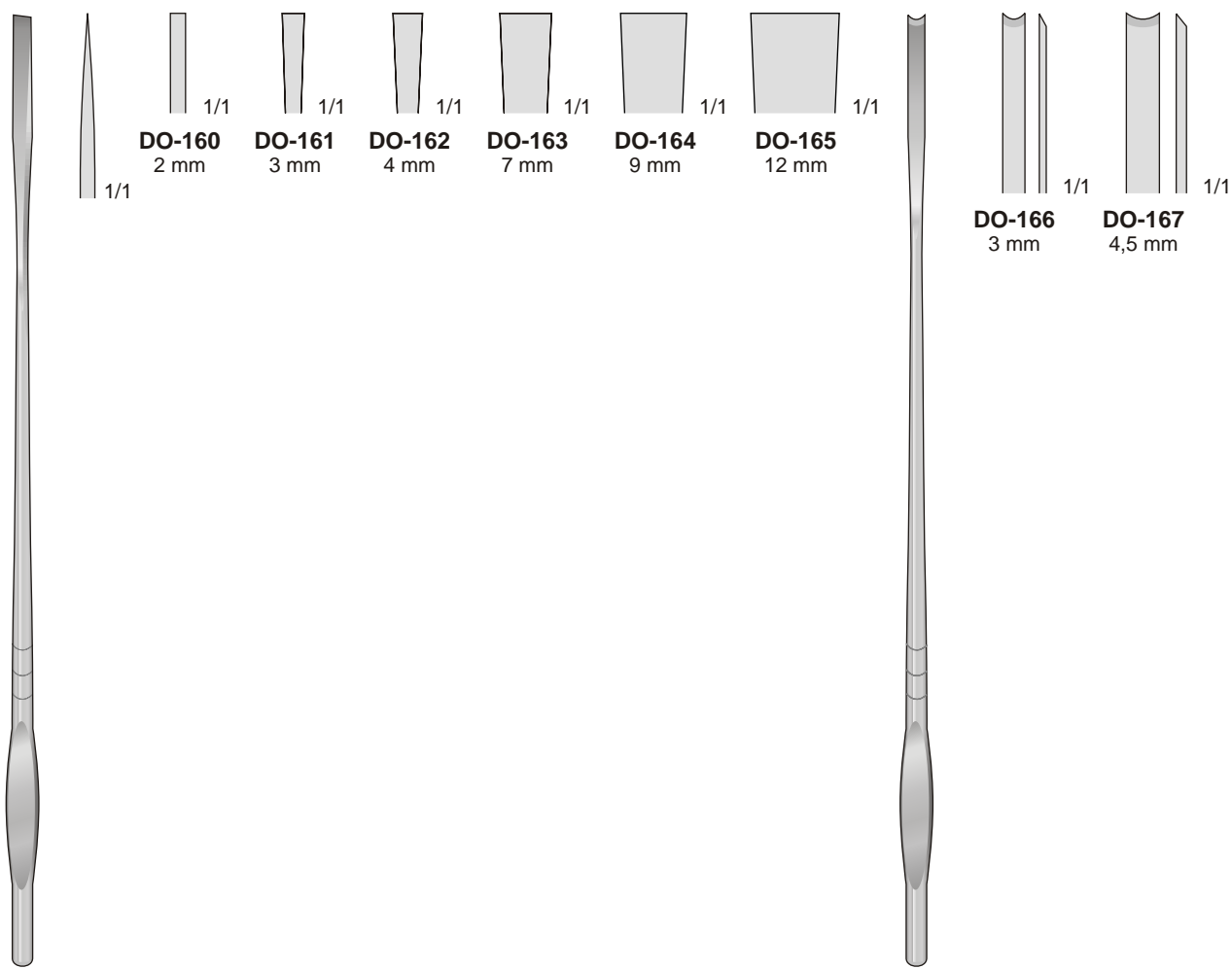

WALTER  
DO-160/DO-165  
190 mm

WALTER  
DO-166/DO-167  
190 mm

Rhinologie

Rhinology

Rinologia

Rinologia

Rhinologie

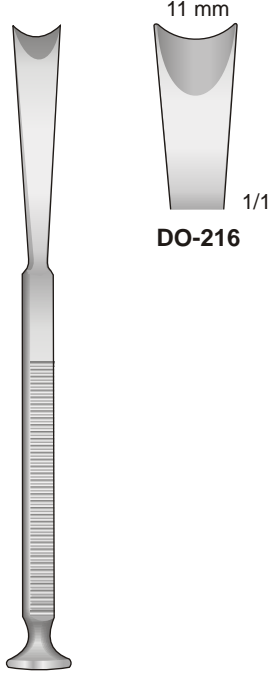

McINDOE  
**DO-216/DO-218**  
145 mm

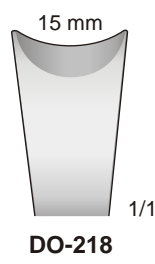
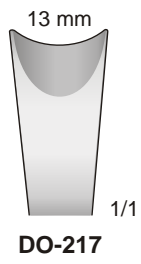
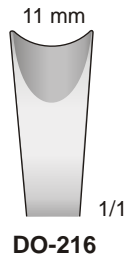

FAULKNER  
**DO-173**  
170 mm

Meißel zur endonasalen  
Kieferhöhlenöffnung  
Antrum Trocar chisel  
Sgorbia per l'apertura endonasale  
della cavità mascellare  
Cinzel para la apertura  
endonasal del seno maxilar  
Gouge pour l'ouverture de la cavité  
endonasale pour sinus maxillaire

Gerade - Straight  
Diritto - Rectas  
Droites

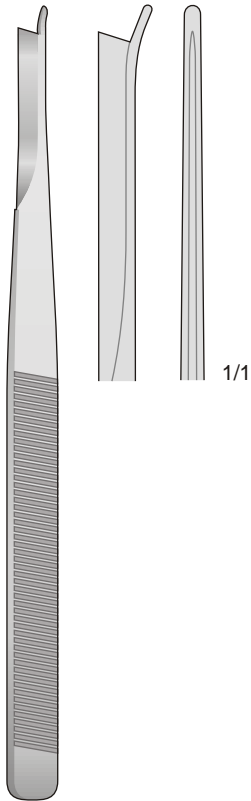

SILVER  
**DO-34**  
180 mm

Links - Left  
Sinistra - Izquierda  
Gauche

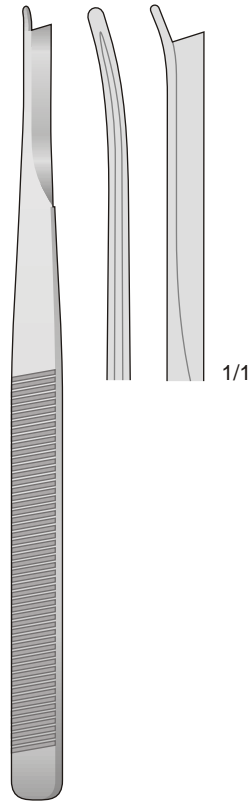

SILVER  
**DO-35**  
180 mm

Rechts - Right  
Destra - Derecha  
Droite

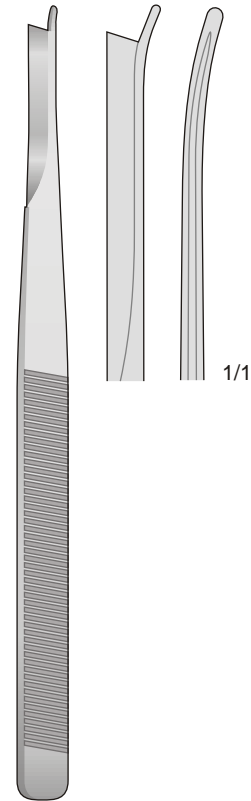

SILVER  
**DO-36**  
180 mm

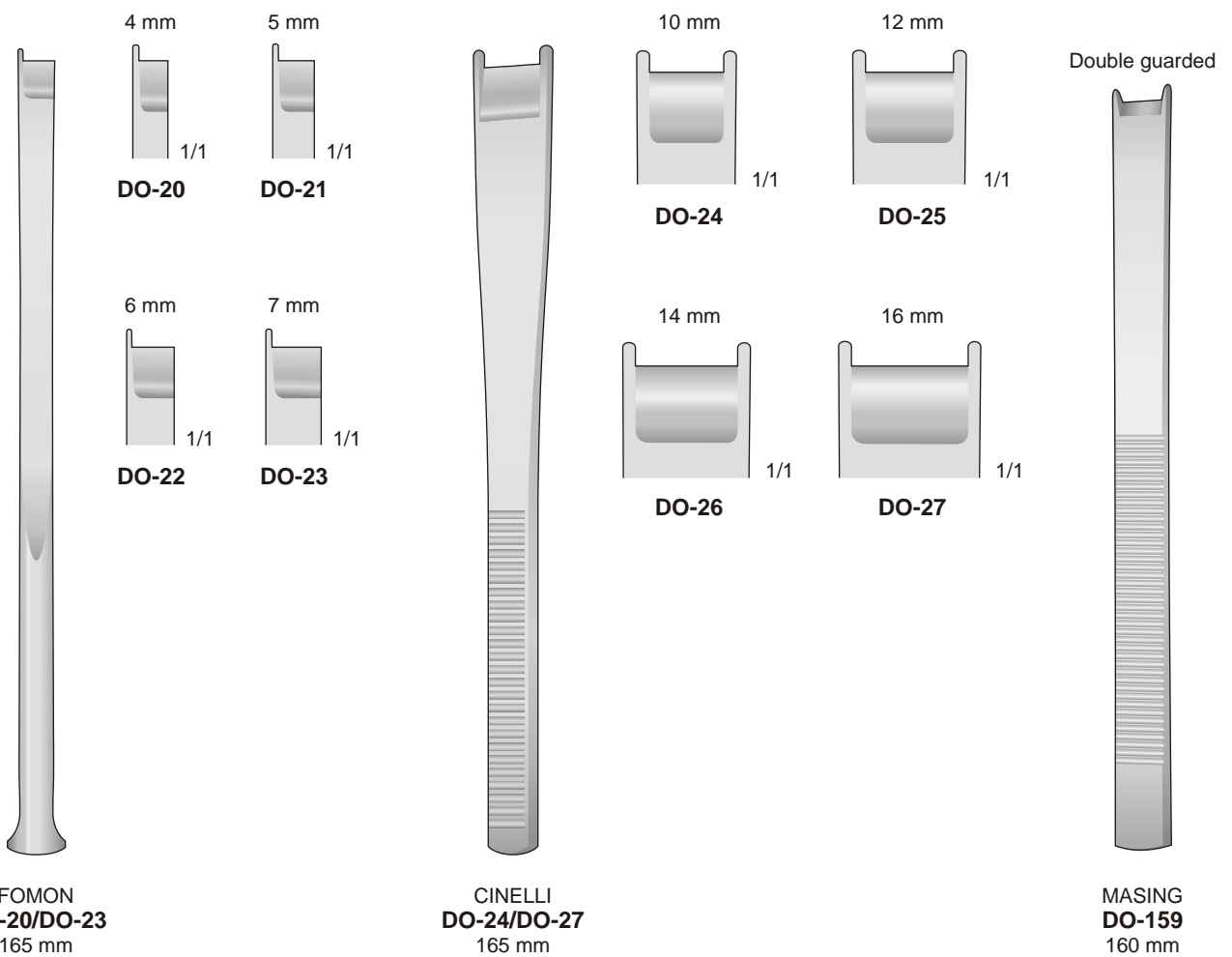

4.0 mm

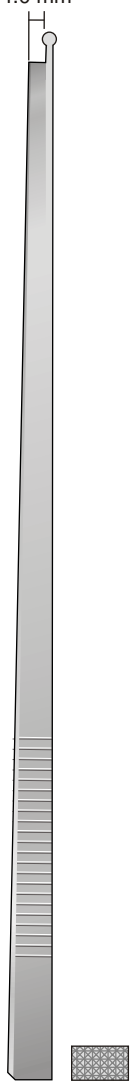

**DO-118**  
200 mm

6.0 mm

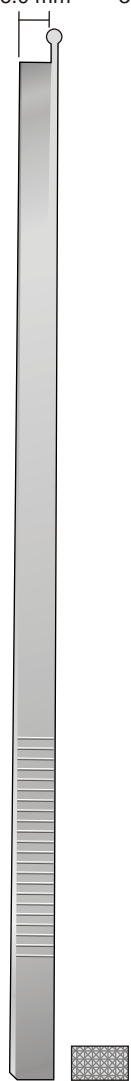

**DO-119**  
200 mm

3.0 mm

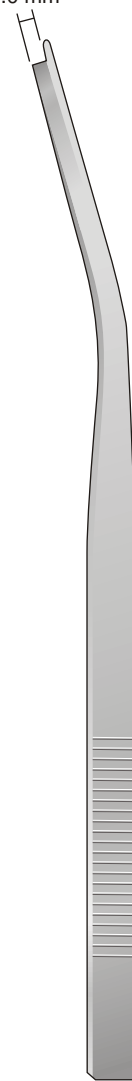

**DO-84**  
200 mm

6.0 mm

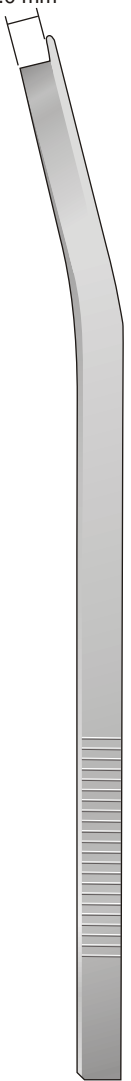

**DO-85**  
200 mm

Osteotome, Osteotomes  
Osteotomi, Osteótomos, Ostéotomes

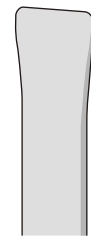

**DO-170**  
10 mm



**DO-171**  
12 mm

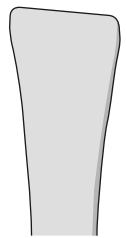

**DO-172**  
14 mm

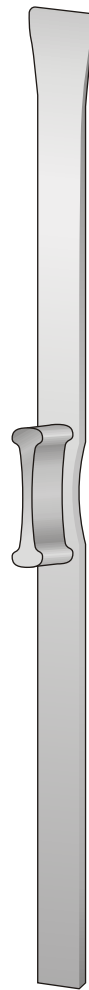

**RUBIN**  
**DO-170/DO-172**  
180 mm

Osteotome

Osteotomes

Osteotomi

Osteòtomos

Ostèotomes

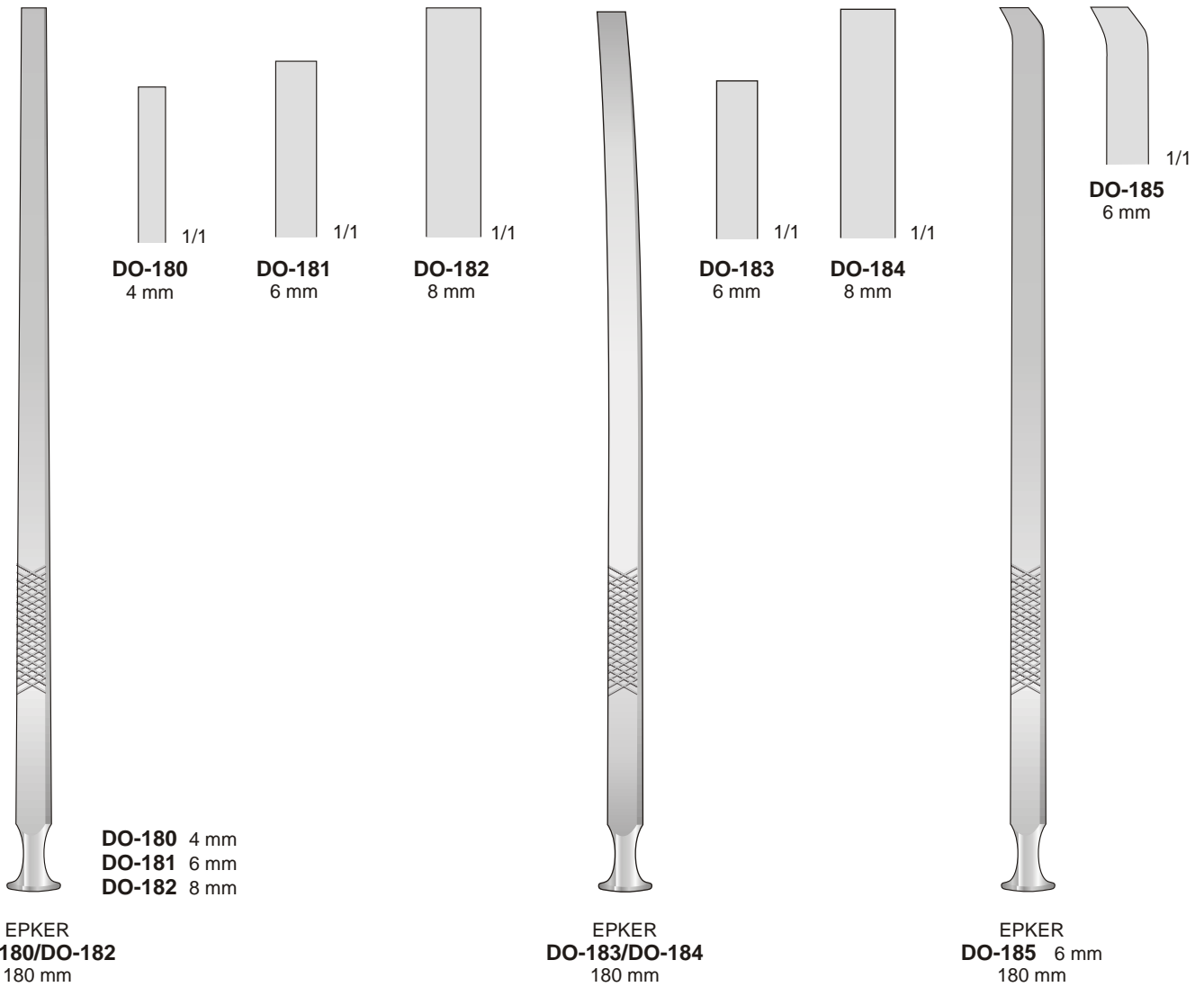

Osteotome

Osteotomes

Osteotomi

Osteòtomos

Ostèotomes

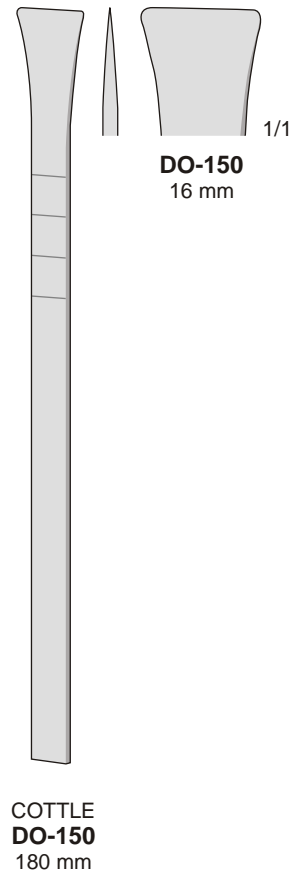
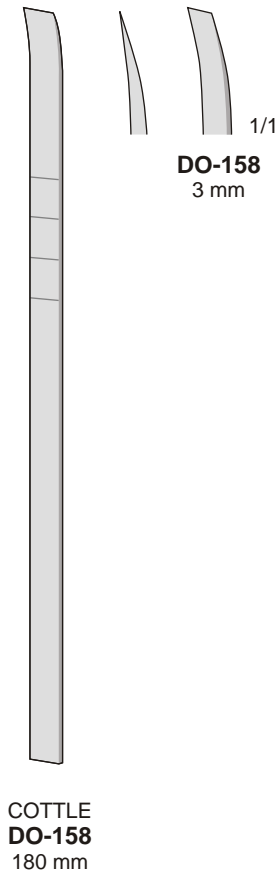
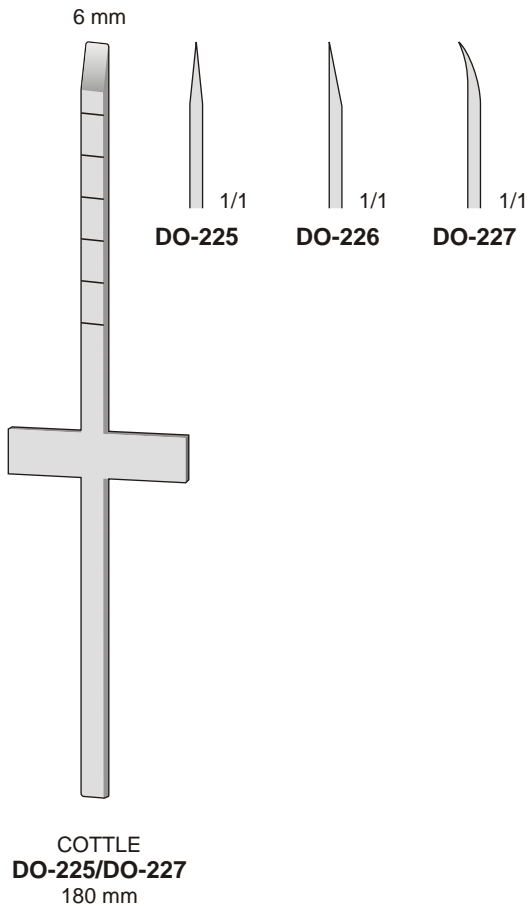



Osteotome

Osteotomes

Osteotomi

Osteòtomos

Ostèotomes

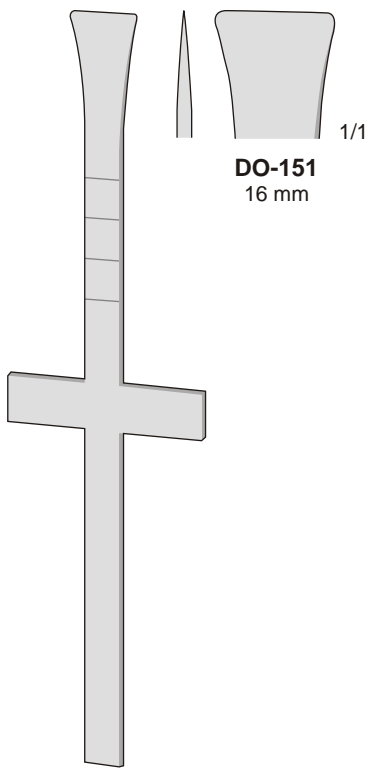

**DO-151**  
16 mm

**COTTLE**  
**DO-151**  
180 mm

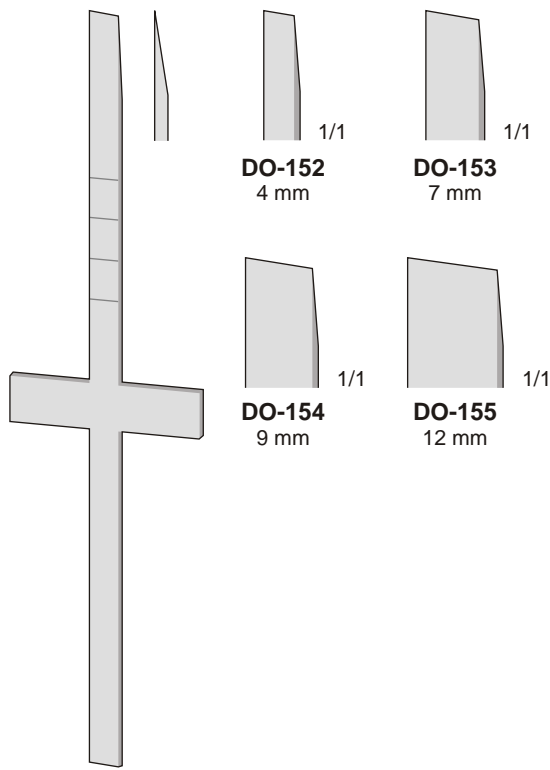

**DO-152**  
4 mm

**DO-153**  
7 mm

**DO-154**  
9 mm

**DO-155**  
12 mm

**COTTLE**  
**DO-152/DO-155**  
180 mm

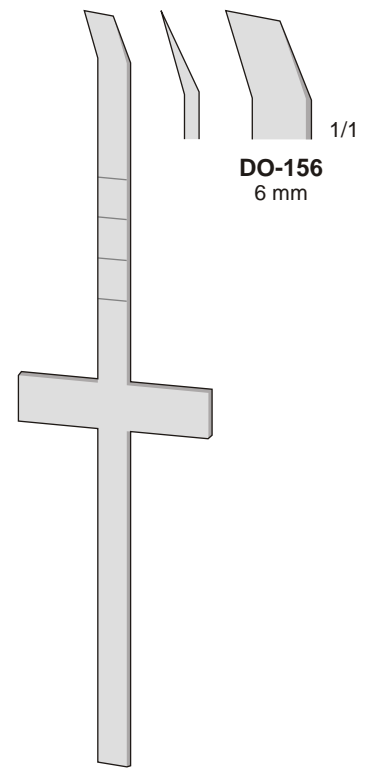

**DO-156**  
6 mm

**COTTLE**  
**DO-156**  
180 mm

Schwingmesser  
Swivel Knife  
Coltello per setto con lama girevole  
Cuchilo para el tabique nasal  
Couteau pour la cloison nasale

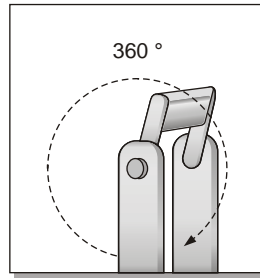

**BALLENGER  
DO-50/DO-52  
200 mm**



**DO-50  
3 mm**



**DO-51  
4 mm**



**DO-52  
5 mm**



**BALLENGER  
DO-53/DO-55  
200 mm**



**DO-53  
3 mm**



**DO-54  
4 mm**



**DO-55  
5 mm**

Osteotome

Osteotomes

Osteotomi

Osteòtomos

Ostèotomes



**FL-401**  
10 mm  
**FL-402**  
14 mm  
**FL-403**  
18 mm

TESSIER  
**FL-401/FL-403**  
160 mm

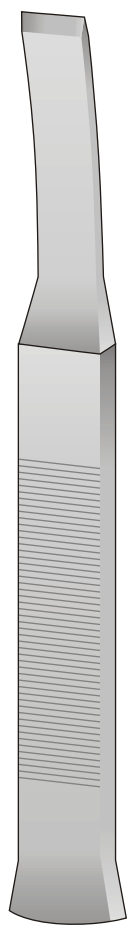

TESSIER  
**FL-404** 10 mm  
160 mm

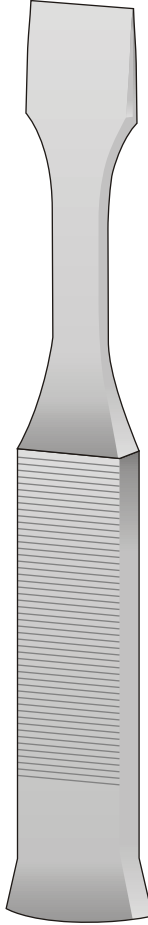

TESSIER  
**FL-405** 18 mm  
160 mm

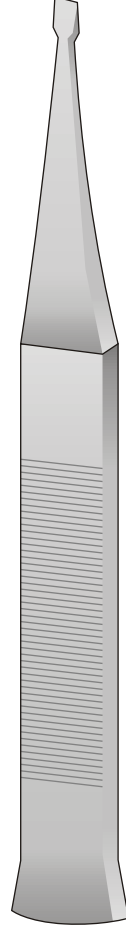

TESSIER  
**FL-410** 3,5 mm  
160 mm

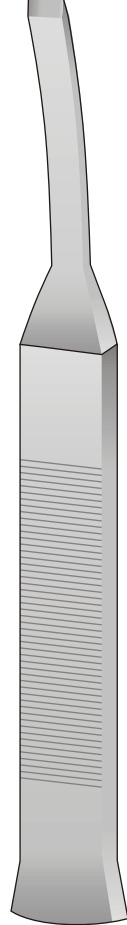

TESSIER  
**FL-411/FL-412**  
160 mm

**FL-411**  
5 mm  
**FL-412**  
7 mm

Osteotome

Osteotomes

Osteotomi

Osteòtoms

Ostèotomes

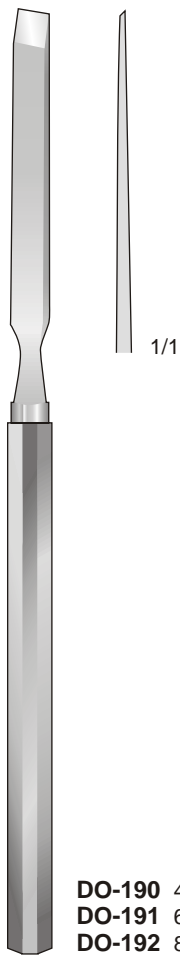

**DO-190/DO-192**  
180 mm

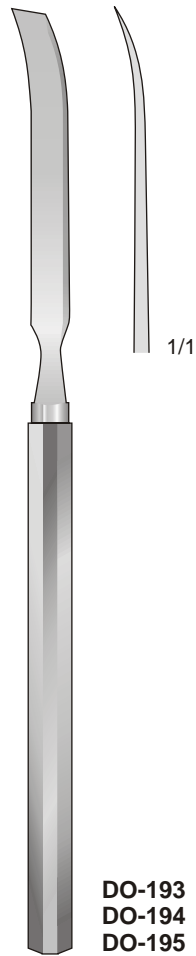

**DO-193/DO-195**  
180 mm

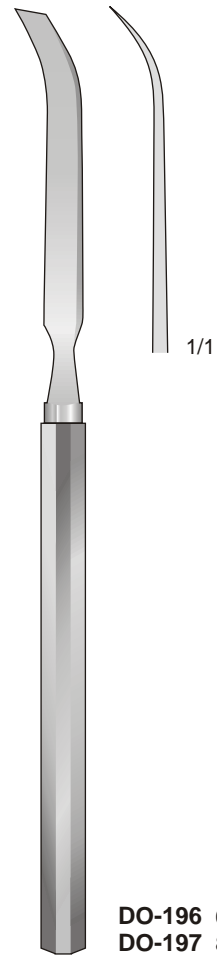

**DO-196/DO-197**  
180 mm

Osteotome

Osteotomes

Osteotomi

Osteòtomas

Ostèotomes

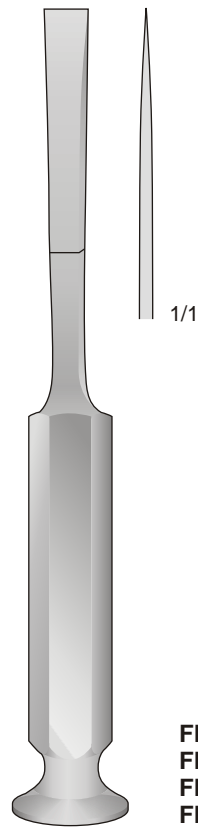

**FL-307** 10 mm  
**FL-308** 15 mm  
**FL-309** 20 mm  
**FL-310** 30 mm

TESSIER  
**FL-307/FL-310**  
 200 mm

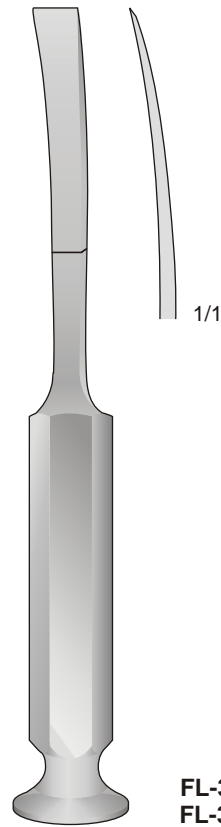

**FL-311** 10 mm  
**FL-312** 15 mm

TESSIER  
**FL-311/FL-312**  
 200 mm

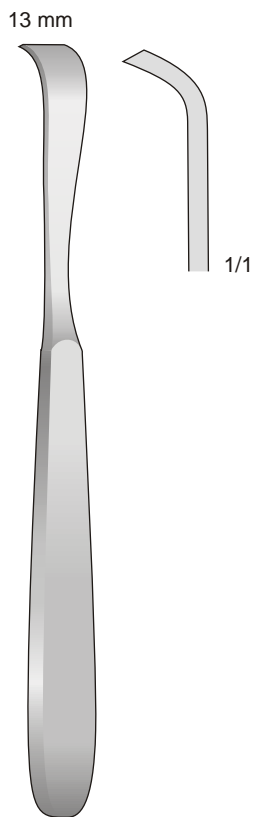

**SCHNEIDER-SAUERBRUCH**  
**FK-259**  
190 mm

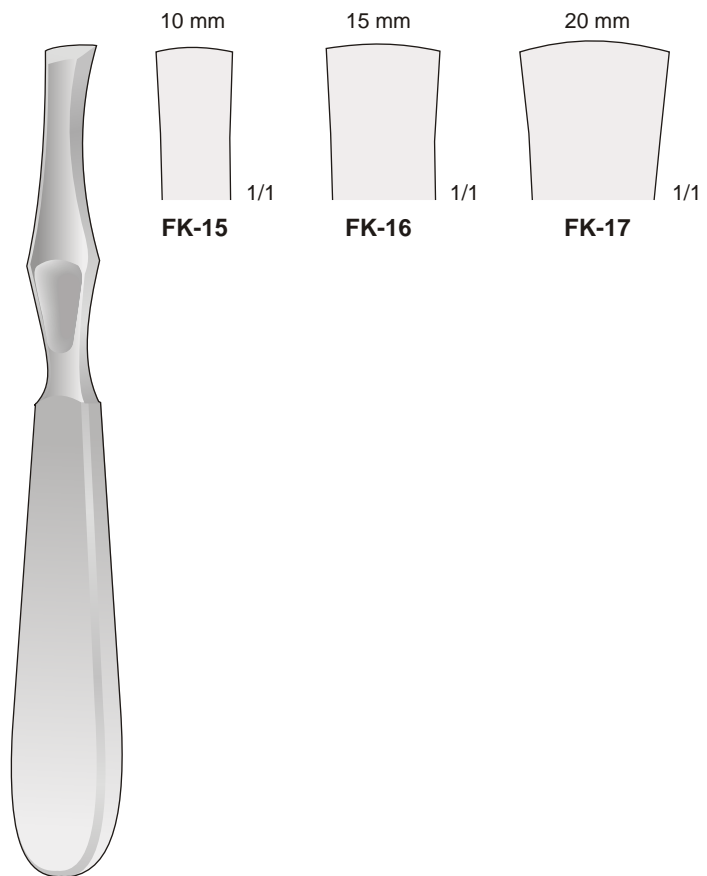

**LAMBOTTE**  
**FK-15/FK-17**  
205 mm

Raspatorien

Periosteal Raspatories

Periostotomi - Raspatori

Periostotomos - Legras

Rugines à périostomie

Mit Ferrozellgriff  
With Ferrozell handle  
Con manico Ferrozell  
Con mango de Ferrozell  
Avec poignée en Ferrozell

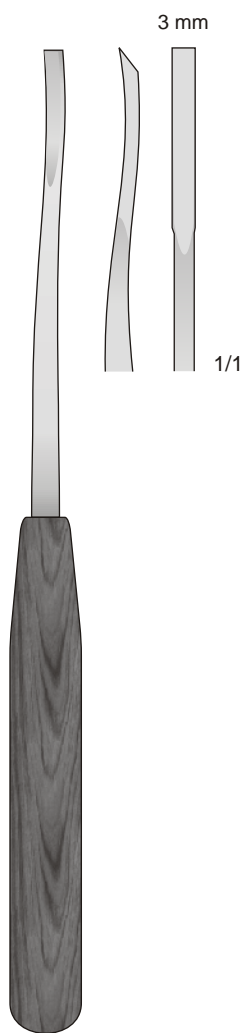

**FK-234**  
180 mm

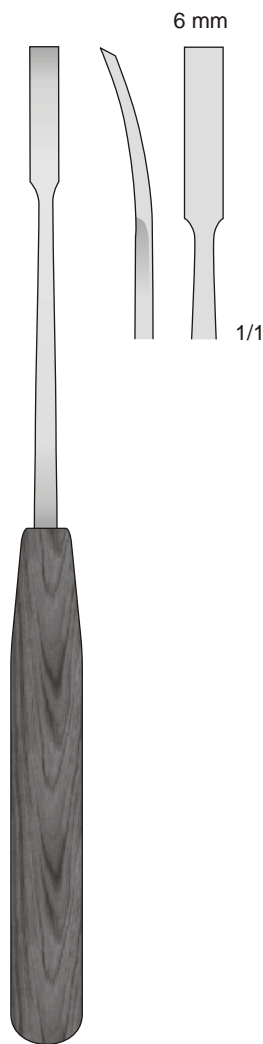

**FK-230**  
190 mm

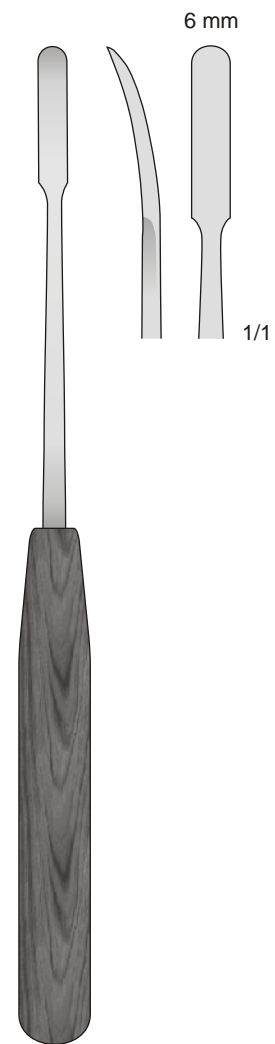

**FK-232**  
190 mm

Mit Ferrozellgriff  
 With Ferrozell handle  
 Con manico Ferrozell  
 Con mango de Ferrozell  
 Avec poignée en Ferrozell



MINI-LEXER  
**FL-230/FL-234**  
 180 mm

- FL-230** 4 mm
- FL-231** 6 mm
- FL-232** 8 mm
- FL-233** 10 mm
- FL-234** 12 mm

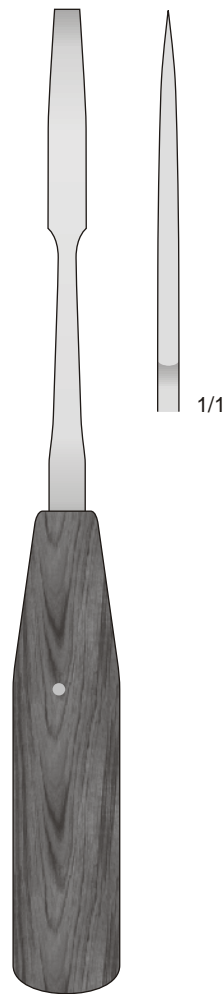

MINI-LEXER  
**FL-59/FL-62**  
 200 mm

- |               |               |
|---------------|---------------|
| 2 mm<br>FL-59 | 4 mm<br>FL-60 |
| 6 mm<br>FL-61 | 8 mm<br>FL-62 |



Osteotome

Osteotomes

Osteotomi

Osteòtomos

Ostèotomes

Mit Ferrozellgriff  
 With Ferrozell handle  
 Con manico Ferrozell  
 Con mango de Ferrozell  
 Avec poignée en Ferrozell

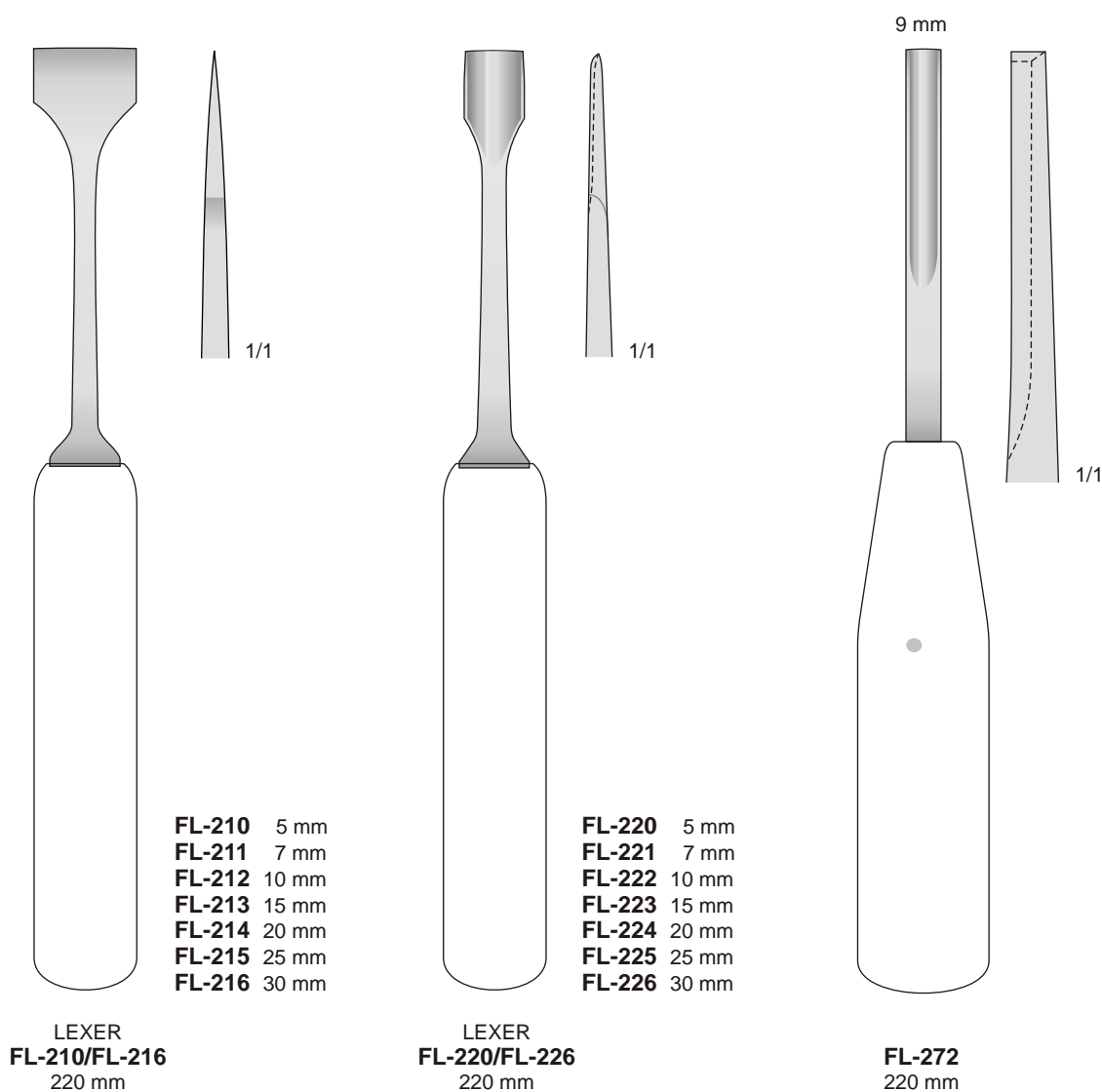

Mit Ferrozellgriff  
 With Ferrozell handle  
 Con manico Ferrozell  
 Con mango de Ferrozell  
 Avec poignée en Ferrozell

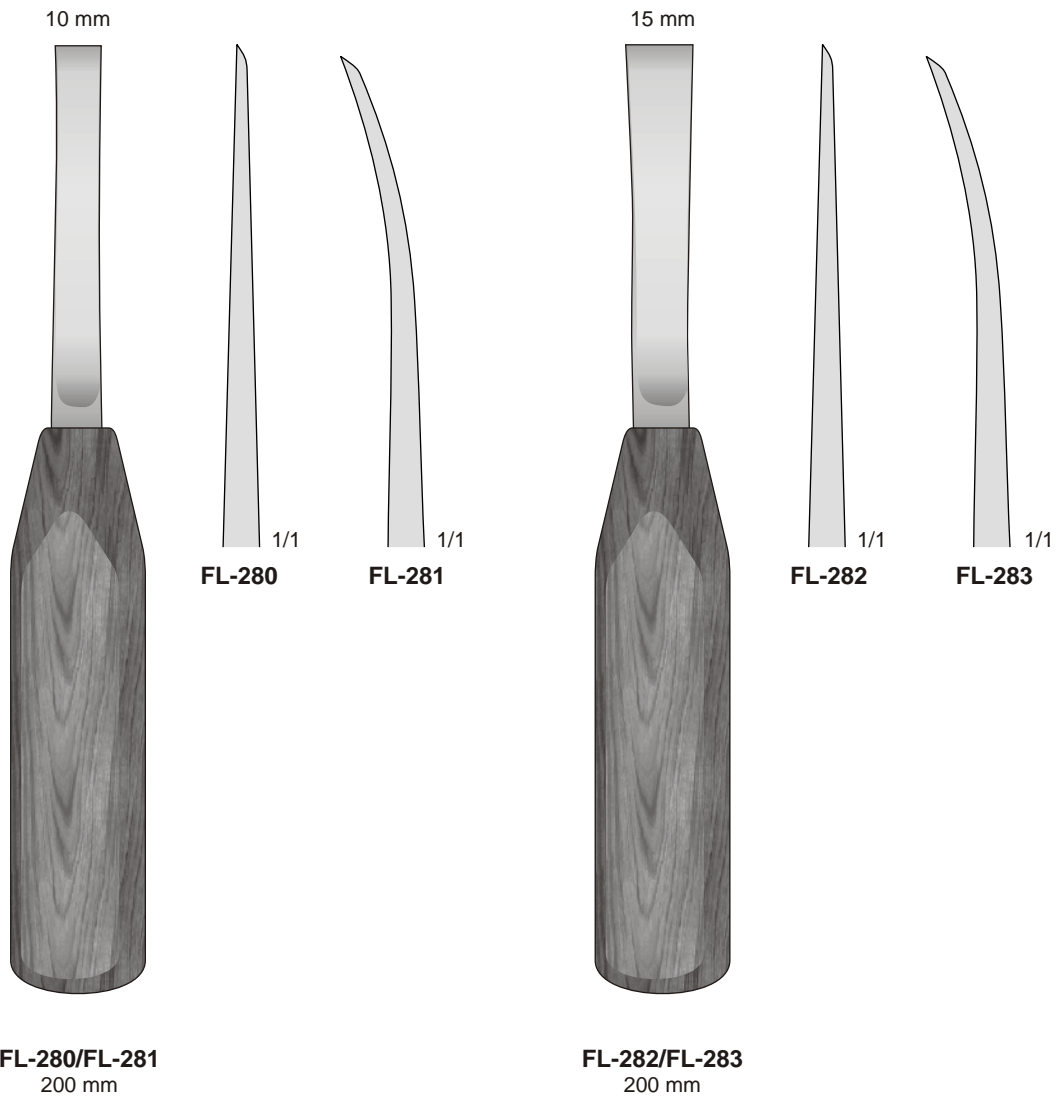

Osteotome

Osteotomes

Osteotomi

Osteòtomos

Ostèotomes

Mit Ferrozellgriff  
 With Ferrozell handle  
 Con manico Ferrozell  
 Con mango de Ferrozell  
 Avec poignée en Ferrozell

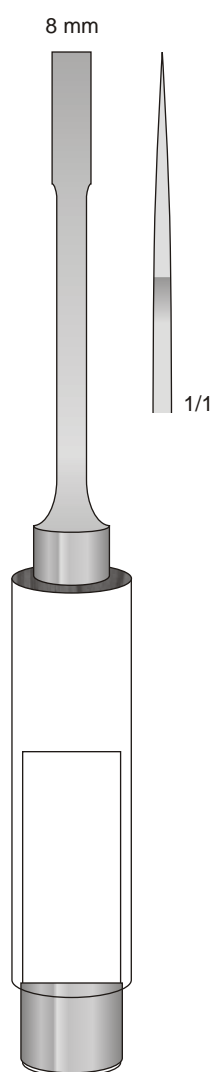

OBWEGESER  
**FL-334**  
 220 mm

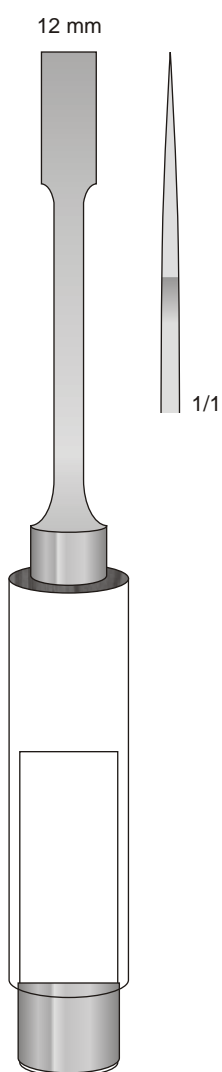

OBWEGESER  
**FL-335**  
 220 mm

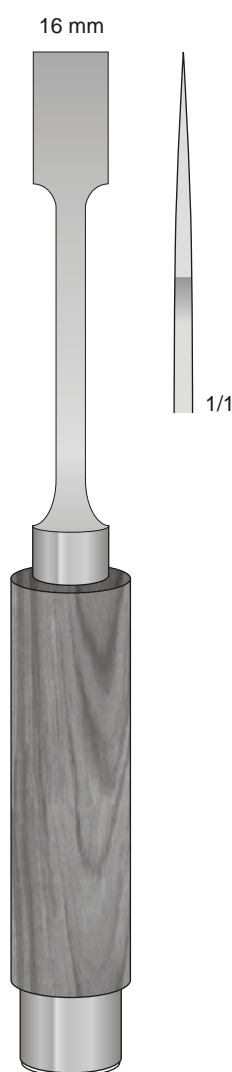

OBWEGESER  
**FL-336**  
 220 mm

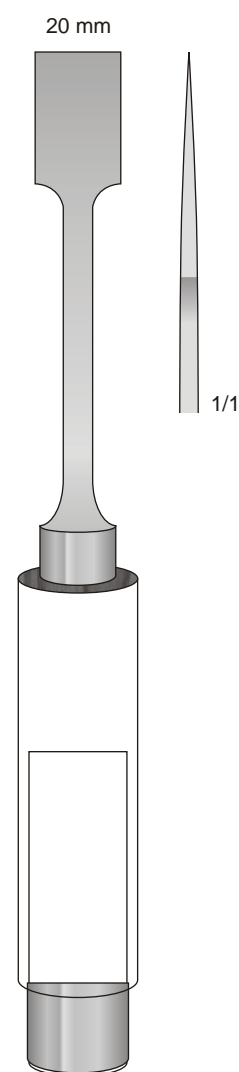

OBWEGESER  
**FL-337**  
 220 mm

Chirurgische Hämmer

Surgical mallets

Martelli chirurgici

Martillos quirurgicos

Maillets chirurgicaux

Ø 25 mm - 200 g



**FL-11R**

Paar Ersatzbacken  
Pair of spare faces  
Coppia di teste  
di ricambio  
Pareja de tapas  
intercambiables  
Paire de faces  
de rechange

MEAD  
**FL-11**  
200 mm

Ø 20 mm - 160 g

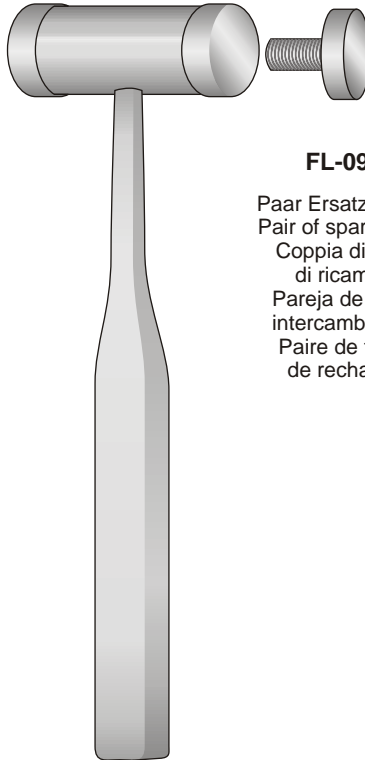

**FL-09R**

Paar Ersatzbacken  
Pair of spare faces  
Coppia di teste  
di ricambio  
Pareja de tapas  
intercambiables  
Paire de faces  
de rechange

MEAD  
**FL-09**  
190 mm

Ø 26 mm - 320 g

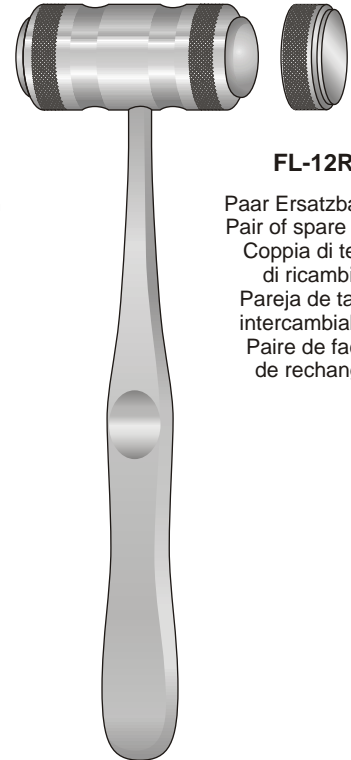

**FL-12R**

Paar Ersatzbacken  
Pair of spare faces  
Coppia di teste  
di ricambio  
Pareja de tapas  
intercambiables  
Paire de faces  
de rechange

MEAD  
**FL-12**  
190 mm

Ø 20 mm - 140 g

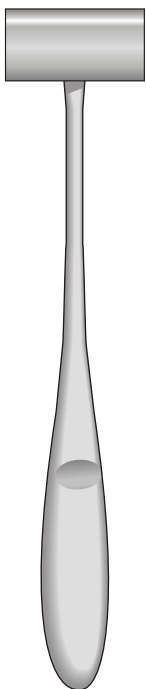

**FL-01**  
165 mm

Ø 25 mm - 300 g

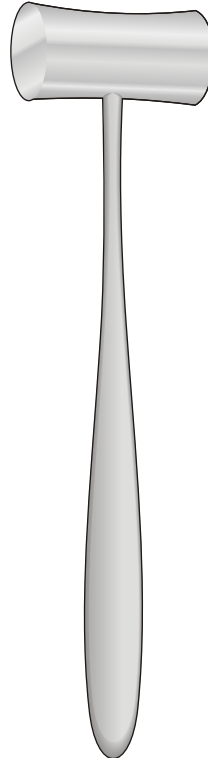

LUCAE  
**FL-10M**  
190 mm

Ø 20 mm - 240 g

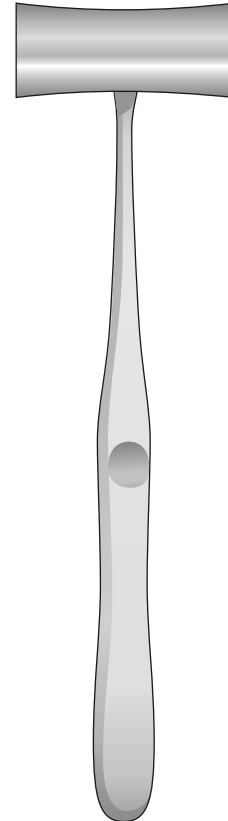

WILLIGER  
**FL-02**  
240 mm

1 Seite flach - 1 Seite convex  
 1 Side flat - 1 Side convex  
 1 Lato piatto - 1 Lato convesso  
 1 Parte plana - 1 Parte convexe  
 1 Face plate - 1 Face convexe

Ø 30 mm - 240 g

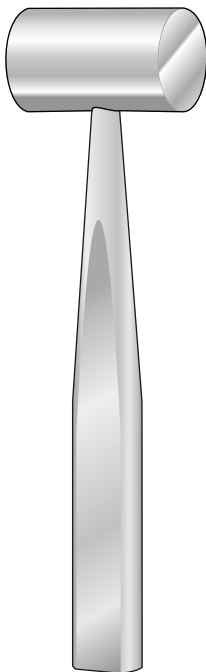

**COTTLE**  
**FL-104**  
 185 mm

Ø 30 mm - 300 g

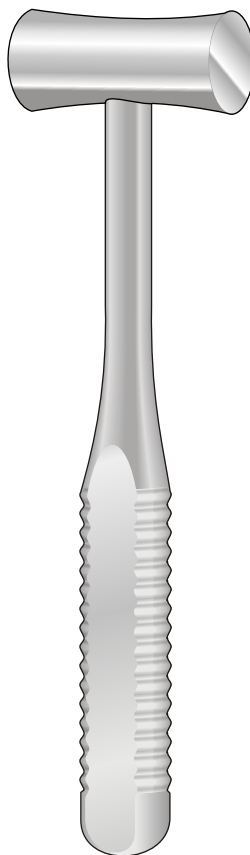

**BERGMANN**  
**FL-105**  
 235 mm

Ø 40 mm - 550 g

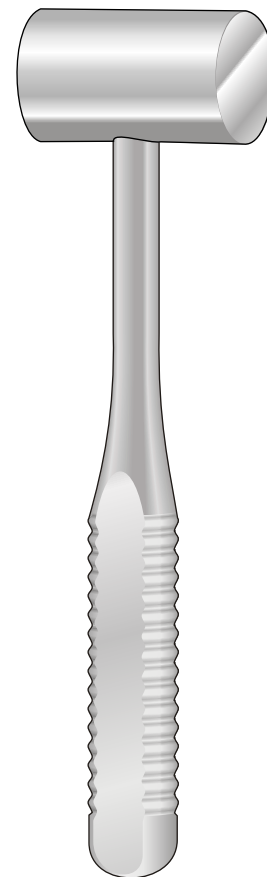

**OMBREDANNE**  
**FL-108**  
 240 mm





**SADIQ SURGICAL CO.**

Catalogue 2015 / 2016



9

Nasenraspeln, Küretten  
Nasal Raspatories, Curettes  
Raspe nasali, Cucchiari  
Raspadores nasales, Cucharillas  
Rugines nasales, Curettes





Knochenfeilen

Bone files

Lime per osso

Limas para huesos

Limes à os

Fig. 67

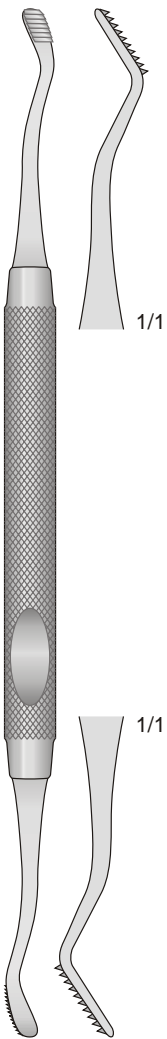

HOWARD  
DO-1  
180 mm

Fig. 45

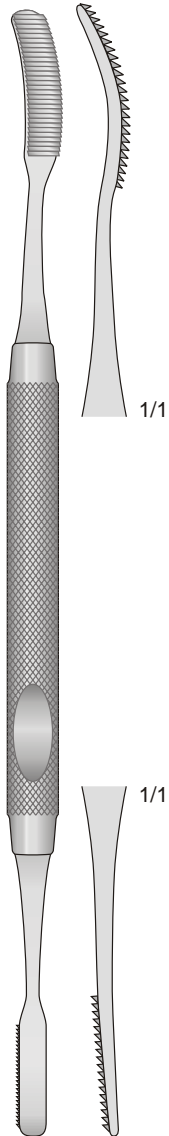

MILLER  
DO-2  
185 mm

Fig. 52

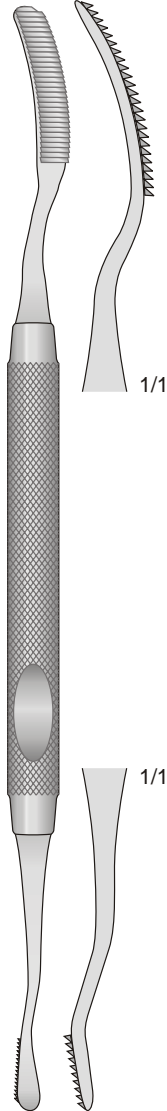

MILLER  
DO-3  
180 mm

Fig. 12

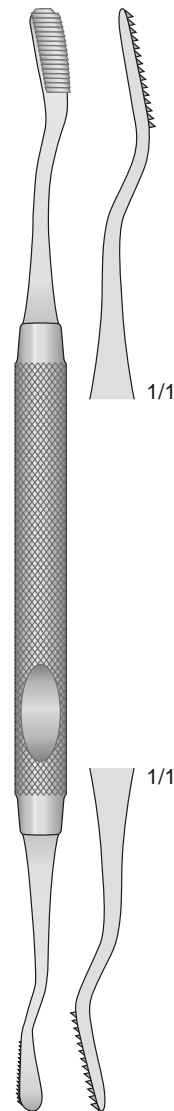

HOWARD  
DO-4  
170 mm

Fig. 64

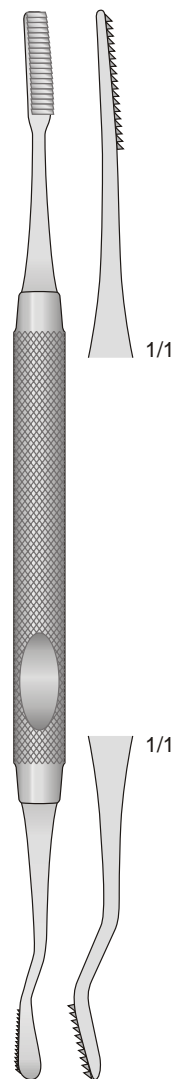

MILLER  
DO-5  
175 mm

Nasenraspeln - Nasal Rasps  
 Raspe nasali - Raspadores nasales  
 Râpes nasales



**CONVERSE**  
**FK-174**  
 180 mm

8 mm



8 mm  
**FK-96**  
 210 mm

2 mm



5 mm  
**FK-97**  
 210 mm



1/1



1/1

8 mm



8 mm  
**FK-98**  
 210 mm

8 mm



8 mm  
**FK-99**  
 210 mm

Knochenfeilen

Bone files

Lime per osso

Limas para huesos

Limes à os

Nasenfeilen  
Nasal File  
Lima nasale  
Lima nasales  
Lime nasales

Nasenraspel  
Nasal Rasp  
Raspa nasale  
Raspador nasal  
Râpe nasale

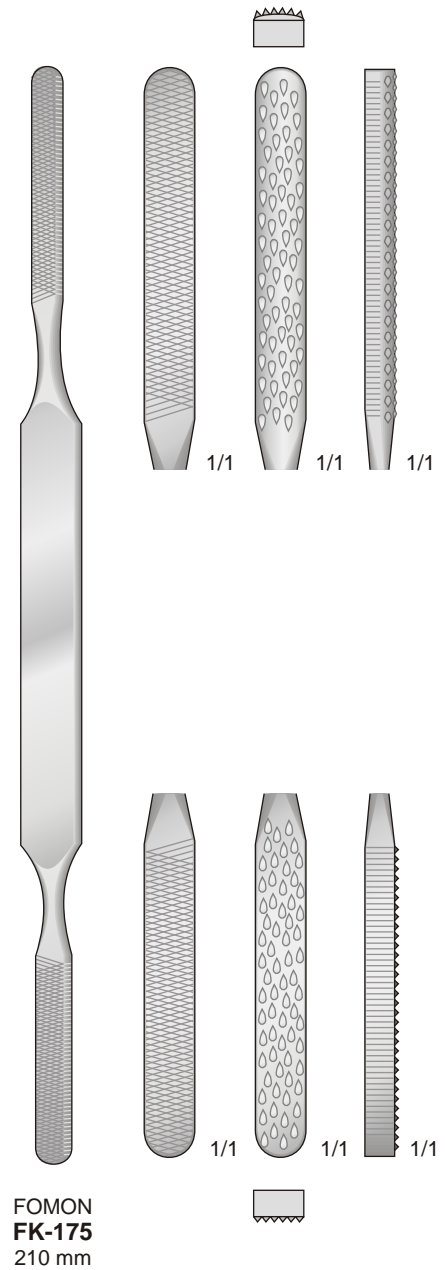
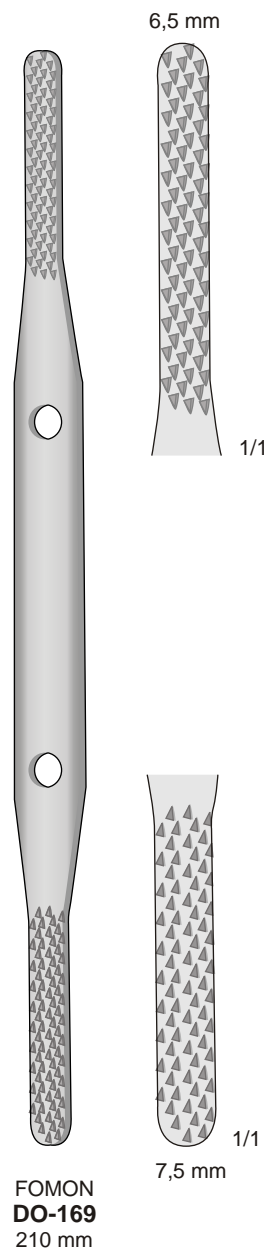
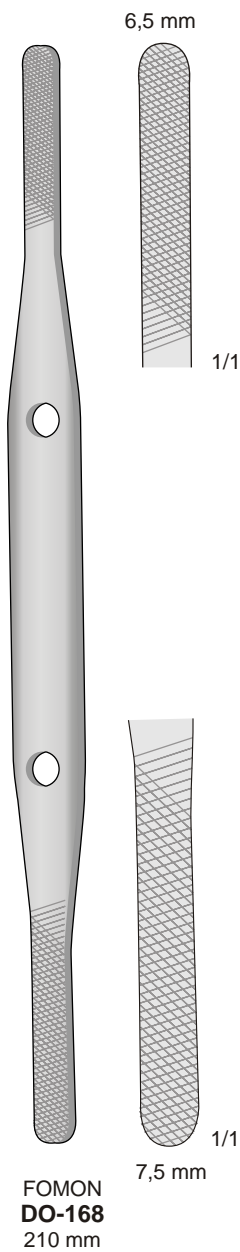

Knochenfeilen

Bone files

Lime per osso

Limas para huesos

Limes à os

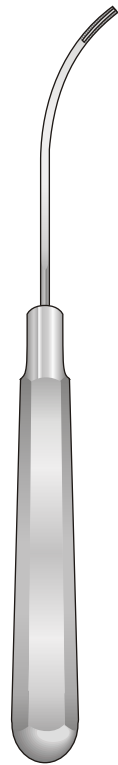

**DINGMANN  
DO-245**  
160 mm  
# 1-L

Knorpelschaber  
Cartilage abraders  
Raschiatore per cartilagine  
Rascador de cartilago  
Grattoir à cartilages

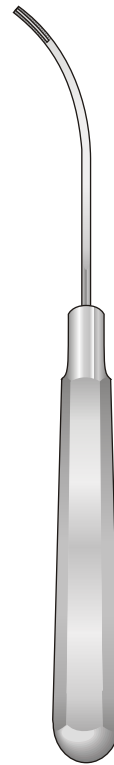

**DINGMANN  
DO-246**  
160 mm  
# 2-R

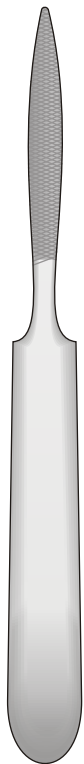

**JOSEPH  
FK-193**  
160 mm

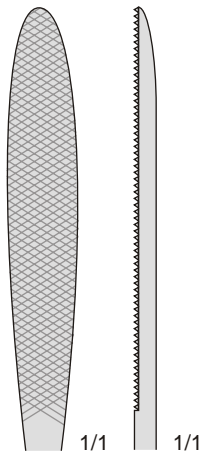

**FK-193**  
160 mm

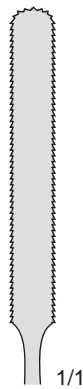

1/1



1/1

**FK-194**  
160 mm



1/1

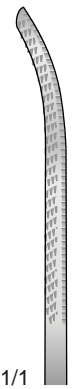

1/1

**FK-195**  
160 mm



1/1



1/1

**FK-196**  
160 mm

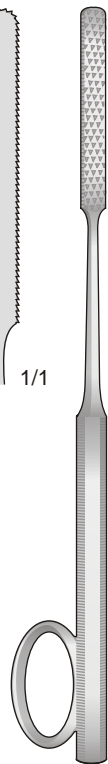

**GALLAHER  
FK-194/FK-196**  
160 mm

Knochenfeilen

Bone files

Lime per osso

Limas para huesos

Limes à os

Glabellaraspeln - Nasenraspeln  
 Glabella Rasps - Nasal Rasps  
 Raspe per glabella - Raspe nasali  
 Escofinas para glabella - Raspadores nasales  
 Râpes pour la glabelle - Râpes nasales

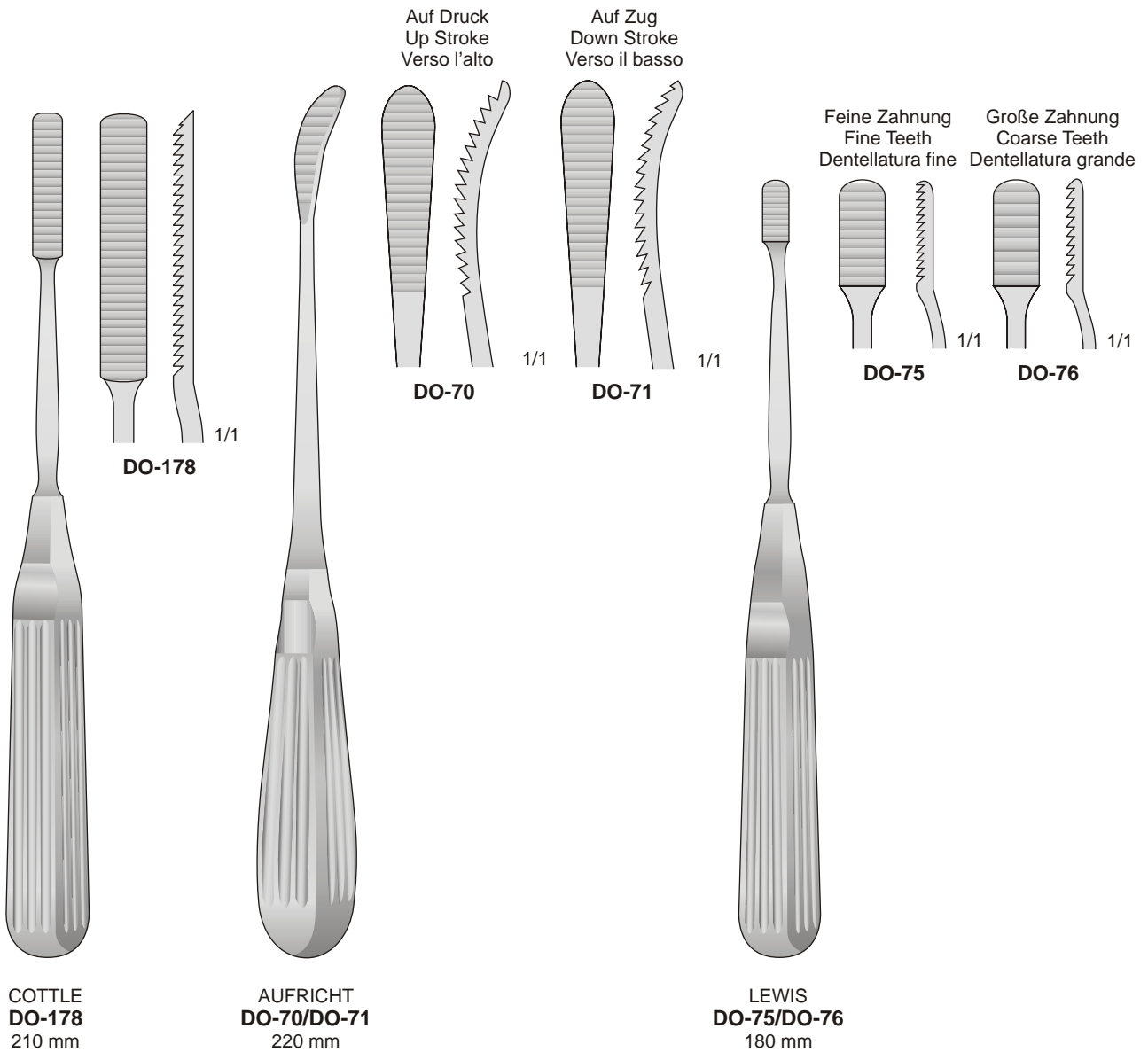

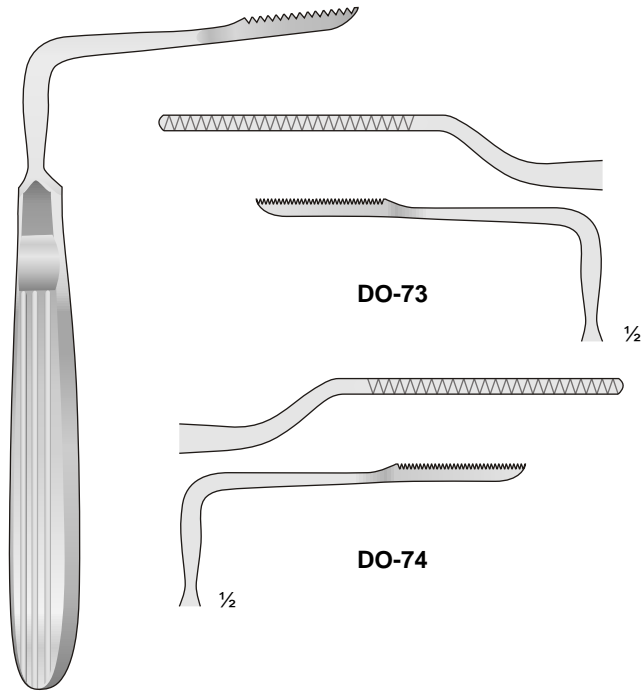

**JOSEPH  
DO-73/DO-74  
135 mm**

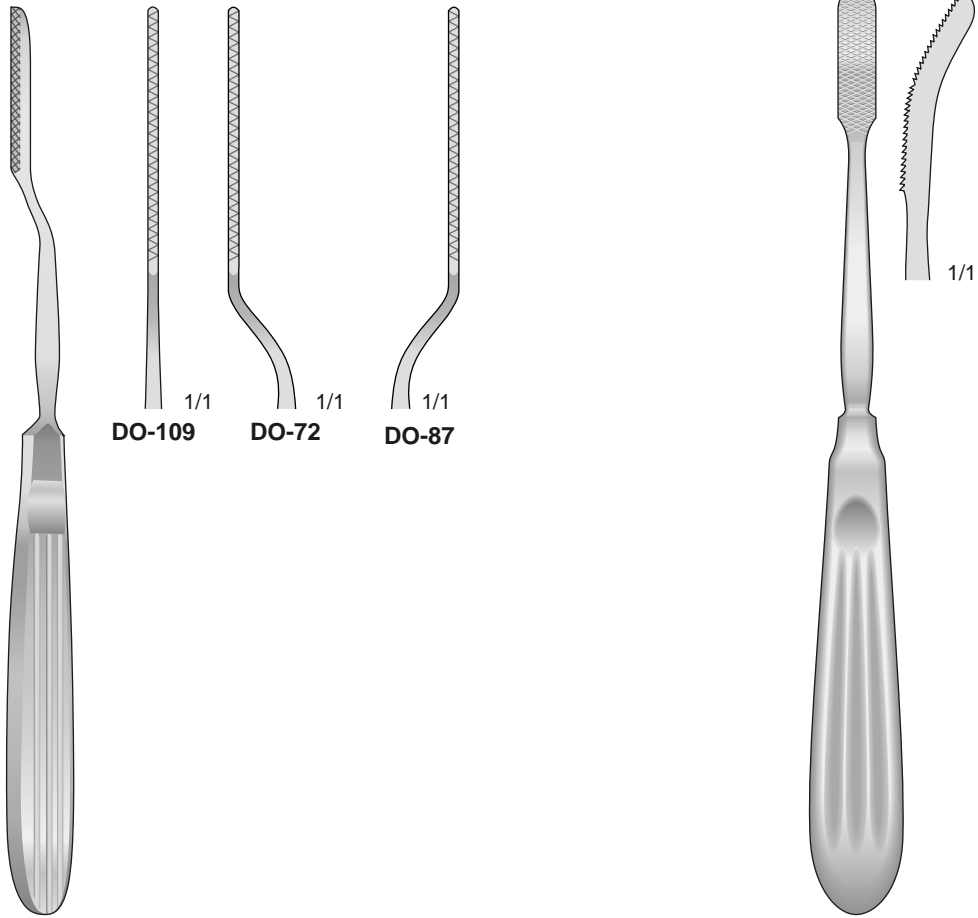

**JOSEPH  
DO-72/DO-109  
190 mm**

**DO-189  
195 mm**

Knochenfeilen

Bone files

Lime per osso

Limas para huesos

Limes à os

Nasenraspeln - Nasal Rasps  
 Raspe nasali - Escofinas nasales  
 Râpes nasales

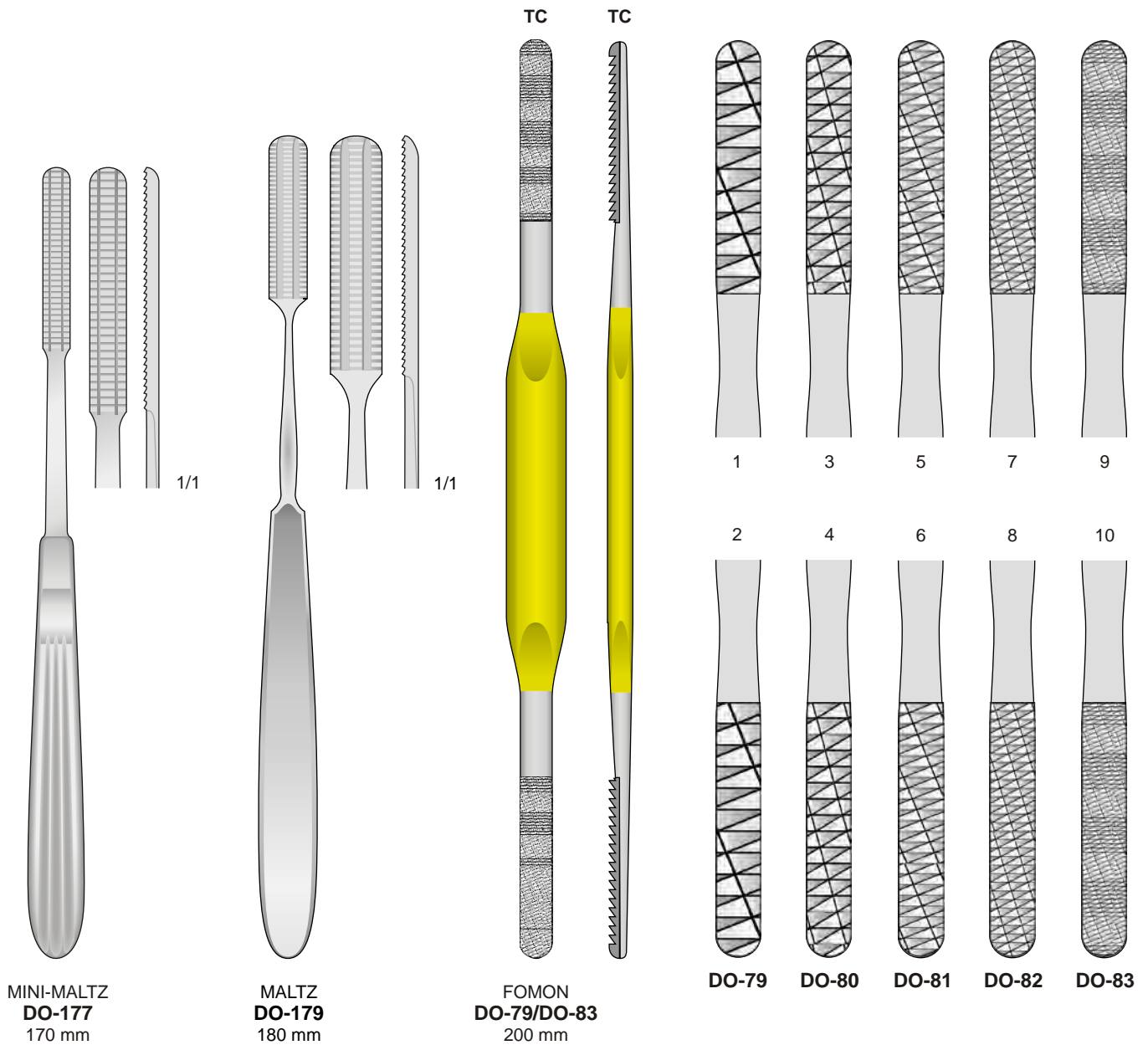

Glabellaraspeln - Nasenraspeln  
 Glabella Rasps - Nasal Rasps  
 Raspe per glabella - Raspe nasali  
 Escofinas para glabella - Raspadores nasales  
 Râpes pour la glabelle - Râpes nasales

Mit hartmetalleinsätzen - Tungsten-carbide inserts  
 Con inserti al carburo di tungsteno - Escofinas con tungsteno  
 Avec plaquettes en carbure de tungstène



**DO-312**  
210 mm

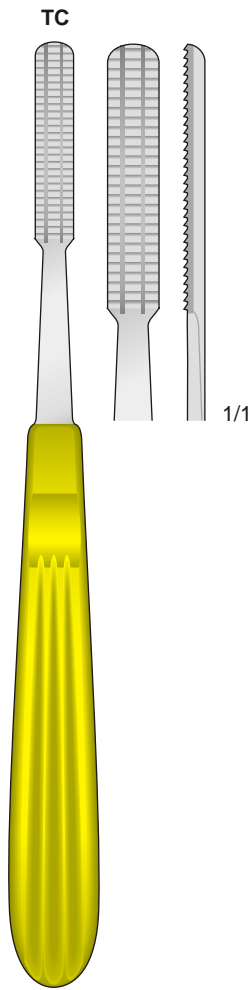

**MALTZ DO-315**  
170 mm



**MALTZ DO-301/DO-305**  
195 mm

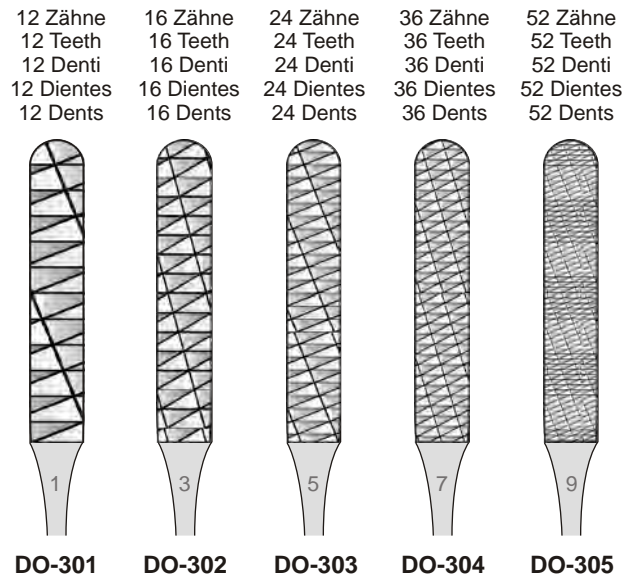



Scharfe Küretten

Sharp curettes

Curette, Cucchiari  
taglianti

Cucharillas cortantes

Curettes tranchantes

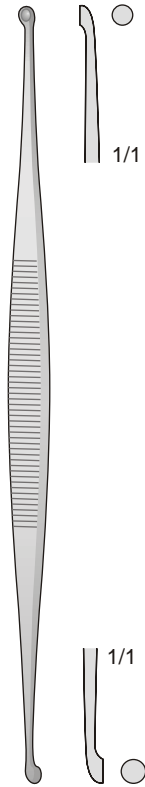

MARTINI  
**FK-70**  
140 mm

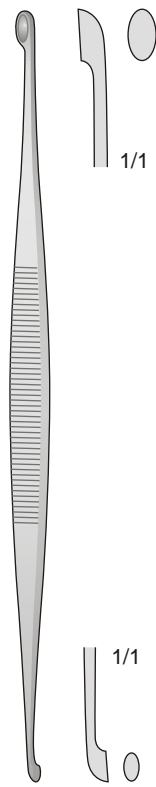

WILLIGER  
**FK-71**  
145 mm

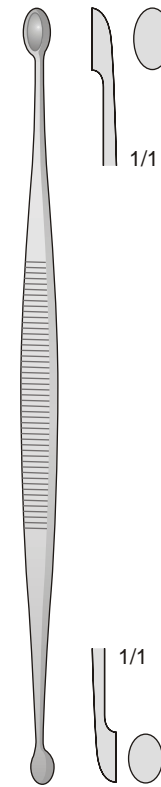

JACOBSON  
**FK-75**  
140 mm

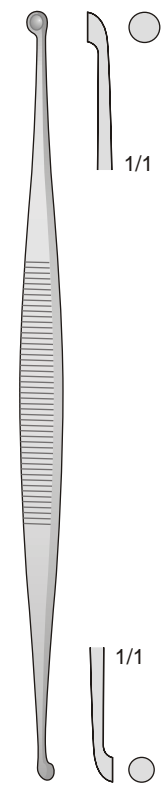

MARTINI  
**FK-76**  
140 mm

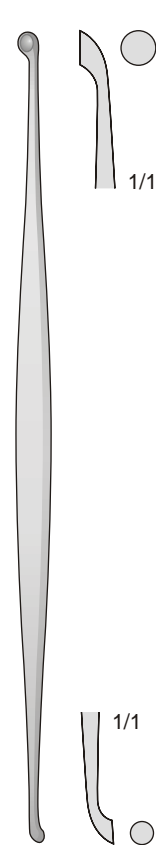

JANSEN  
**FK-77**  
160 mm

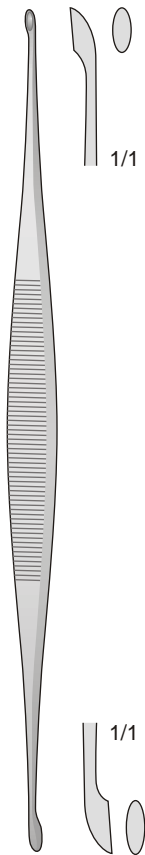

BARTH  
**FK-78**  
180 mm

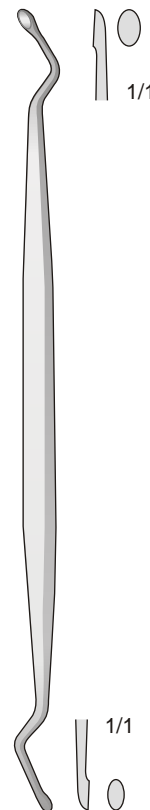

**FK-83**  
160 mm

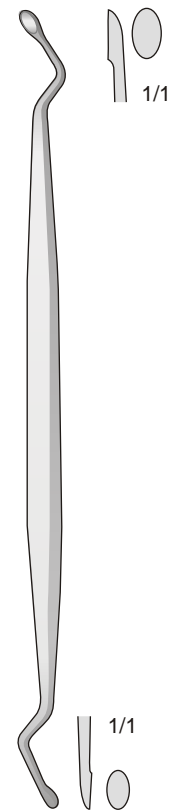

JANSEN  
**FK-84**  
160 mm

Scharfe Küretten

Sharp currettes

Curette, Cucchiai  
taglianti

Cucharillas cortantes

Curettes tranchantes

Komedonen Instrumente  
Comedone Extractors  
Schiacciacomedoni  
Extractores para comedones  
Tire comédons

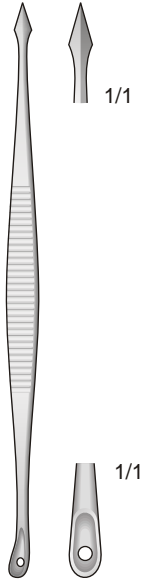

**SAALFELD  
DS-26**  
100 mm

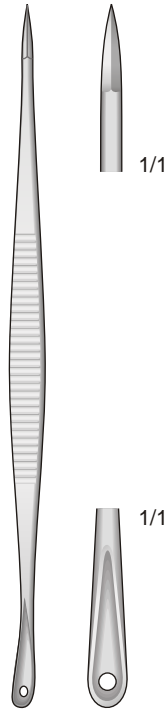

**SAALFELD  
DS-27**  
140 mm

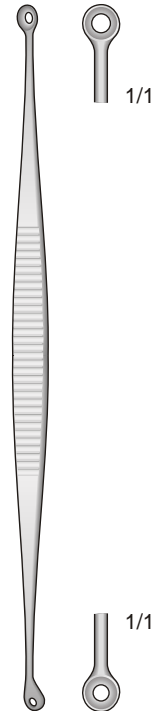

**UNNA  
DS-28**  
140 mm

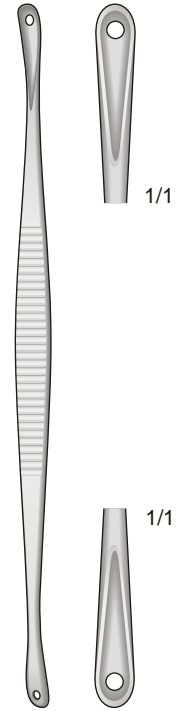

**UNNA  
DS-29**  
140 mm

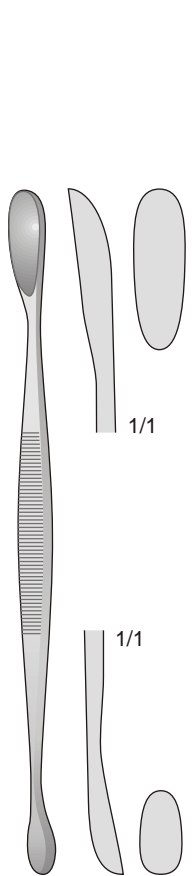

**VOLKMANN  
FK-79**  
130 mm

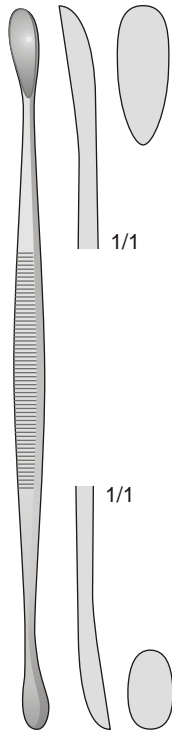

**VOLKMANN  
FK-72**  
145 mm

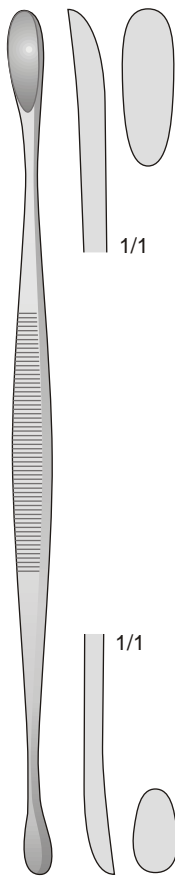

**VOLKMANN  
FK-73**  
170 mm

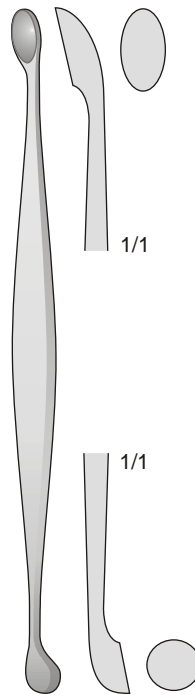

**FK-177**  
130 mm

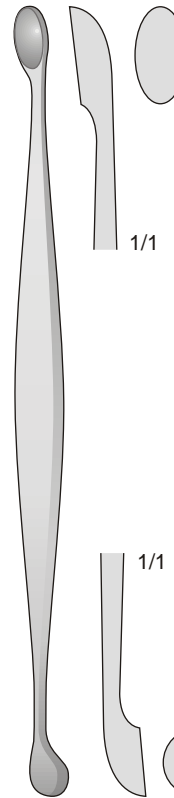

**FK-74**  
160 mm

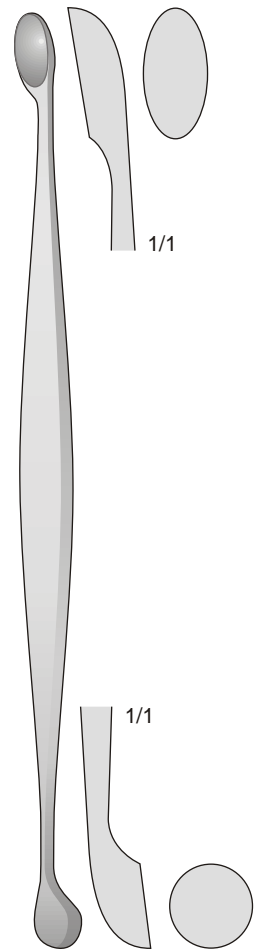

**FK-178**  
200 mm

Scharfe Küretten

Sharp curettes

Curette, Cucchiari  
taglianti

Cucharillas cortantes

Curettes tranchantes

Hautstanzen - Dermal punches Offset  
Punche da biopsia - Trépanos cutáneos - Trépanos cutanés



**FL-150**  
3 mm

**FL-151**  
4 mm

**FL-152**  
5 mm

**FL-153**  
6 mm

**FL-154**  
8 mm

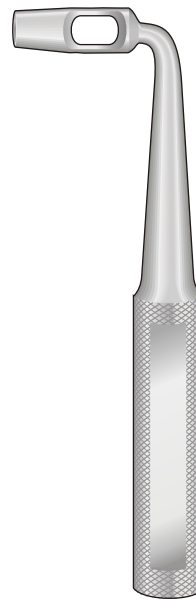

**FL-155**  
3 mm

**FL-156**  
4 mm

**FL-157**  
5 mm

**FL-158**  
6 mm

**FL-159**  
8 mm

KEYES  
**FL-150/FL-154**  
100 mm

KEYES  
**FL-155/FL-159**  
90 mm

Lupus Küretten - Lupus Curettes  
Curette per Lupus - Curetas para Lupus  
Curettes pour les Lupus

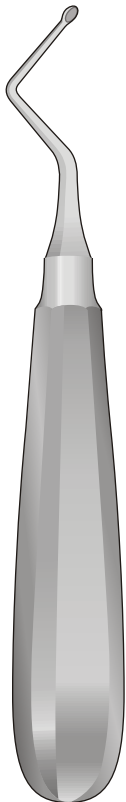

**FK-136**  
**FK-137**

**FK-138**  
**FK-139**

KERPEL  
**FK-136**  
**FK-138**  
145 mm

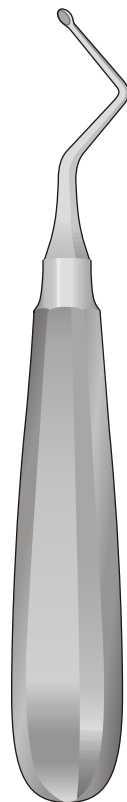

KERPEL  
**FK-137**  
**FK-139**  
145 mm

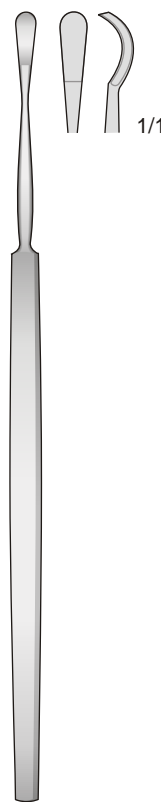

VIDAL  
**DS-25**  
140 mm

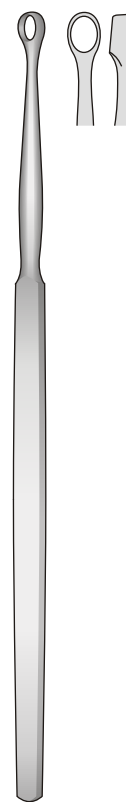

FOX  
**DS-30/DS-33**  
140 mm

3 mm 4 mm 5 mm 6 mm  
**DS-30 DS-31 DS-32 DS-33**

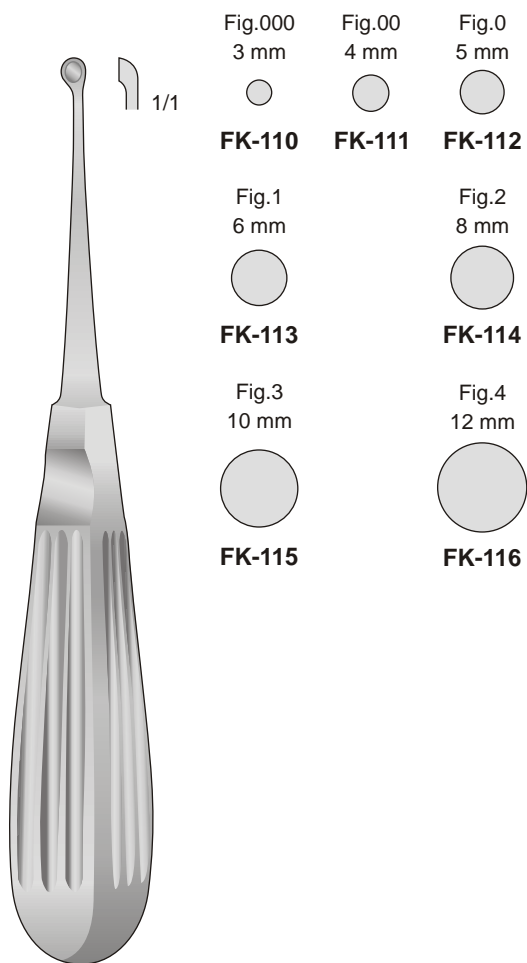

**BRUNS**  
**FK-110/FK-116**  
165 mm

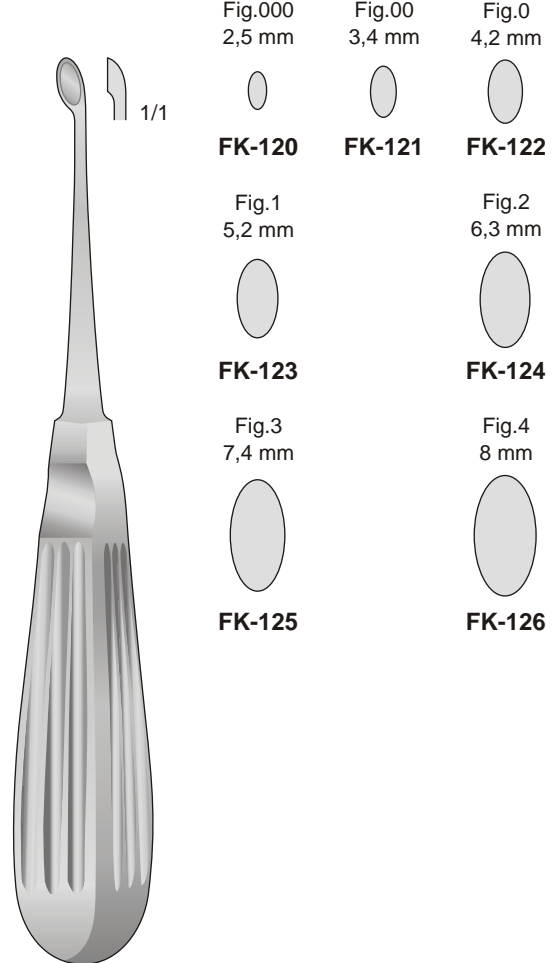

**SCHEDE**  
**FK-120/FK-126**  
170 mm

Scharfe Küretten

Sharp curettes

Curette, Cucchiari  
taglianti

Cucharillas cortantes

Curettes tranchantes

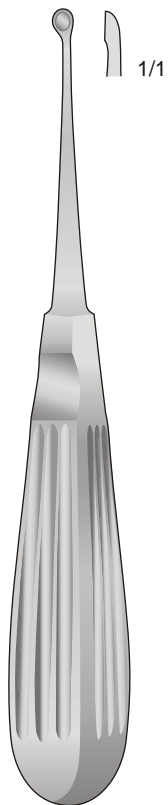

**VOLKMANN**  
**FK-60/FK-69**  
170 mm

Fig.0000  
2,8 mm  
1/1  
**FK-60**

Fig.000  
3,6 mm  
1/1  
**FK-61**

Fig.00  
4,4 mm  
1/1  
**FK-62**

Fig.0  
5,2 mm  
1/1  
**FK-63**

Fig.1  
6,8 mm  
1/1  
**FK-64**

Fig.2  
8,5 mm  
1/1  
**FK-65**

Fig.3  
10 mm  
1/1  
**FK-66**

Fig.4  
11,5 mm  
1/1  
**FK-67**

Fig.5  
13 mm  
1/1  
**FK-68**

Fig.6  
14,5 mm  
1/1  
**FK-69**

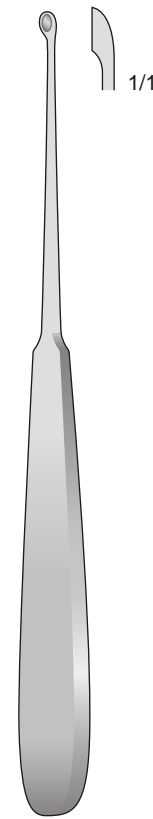

**WILLIGER**  
**FK-197/FK-198**  
170 mm

Fig. 00  
3,4 mm  
1/1  
**FK-197**

Fig. 1  
5,2 mm  
1/1  
**FK-198**

Marker  
Tissue Markers  
Marcatore

Semi-Biegsam - Semi-Malleables  
Semi-Malleabili - Semi-Maleables  
Semi-Malléables

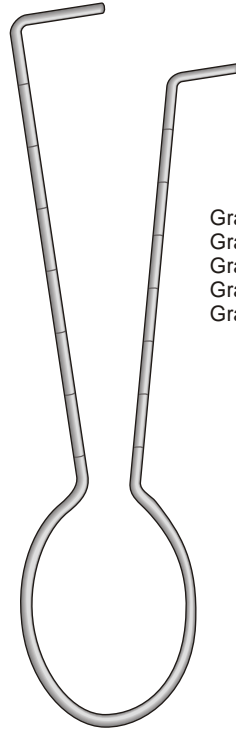

Graduiert cm  
Graduated cm  
Graduati in cm  
Graduadas en cm  
Graduée en cm

- ES-14** 38 mm
- ES-15** 42 mm
- ES-16** 45 mm

Areola-Marker  
Marca Areola

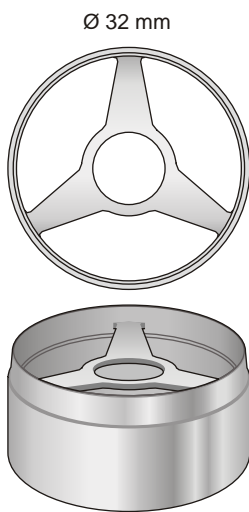

**ES-17**  
32 mm

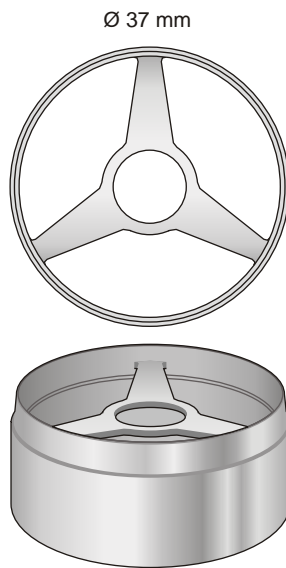

**ES-18**  
37 mm

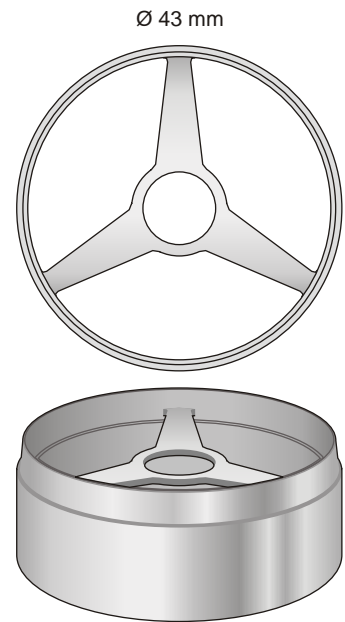

**ES-19**  
43 mm

---

10

Hohlmeißelzangen  
Rongeurs  
Pinze ossivore  
Pinzas gubias  
Pinces gouges





Hohlmeißelzangen

Bone rongeurs

Pinze ossivore

Pinza-gubias

Pinces-gouges

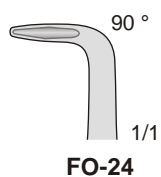
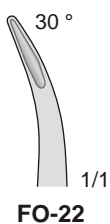
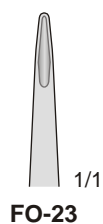
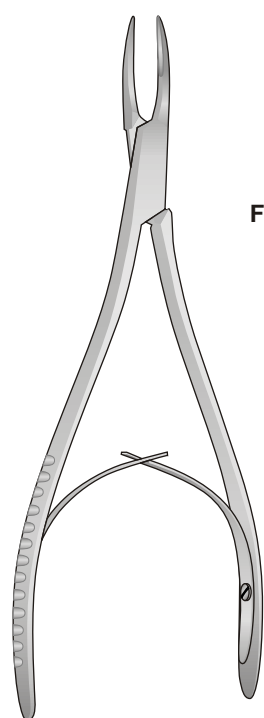

MINI-FRIEDMANN  
FO-22/FO-24  
150 mm

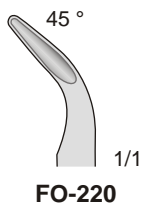
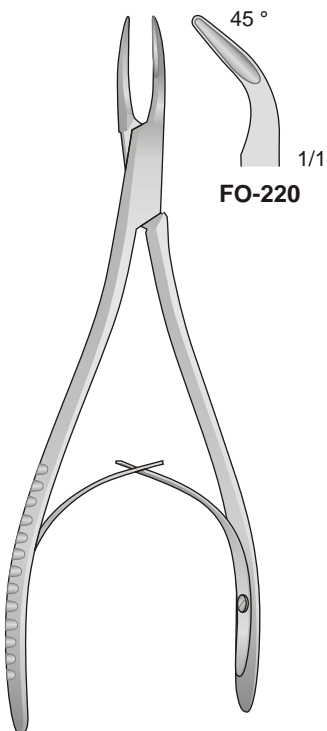

MINI-FRIEDMANN  
FO-220  
150 mm

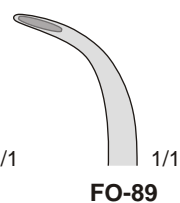
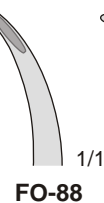
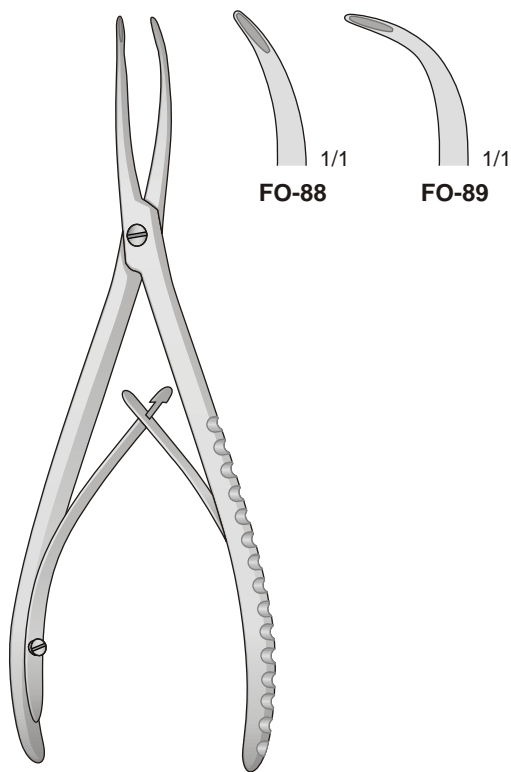

STELLBRINK  
FO-88/FO-89  
170 mm

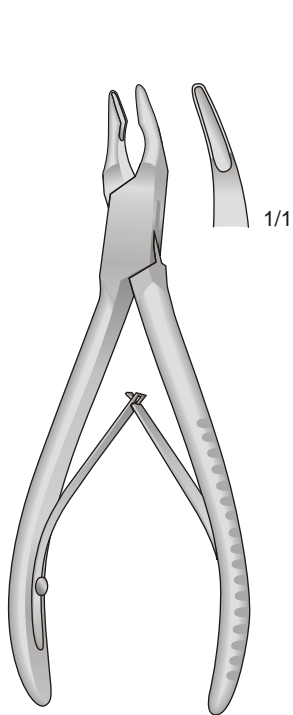

**MINI-FRIEDMANN**  
**FO-15**  
120 mm

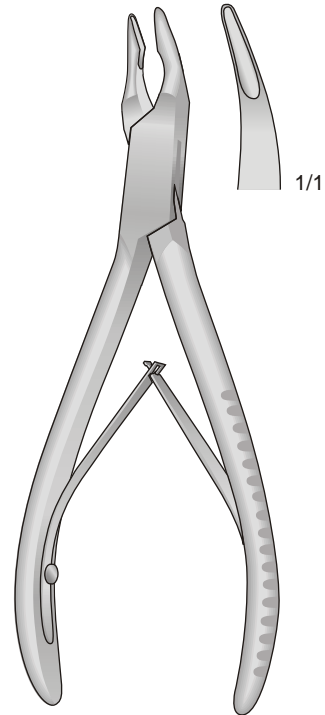

**FRIEDMANN**  
**FO-17**  
140 mm

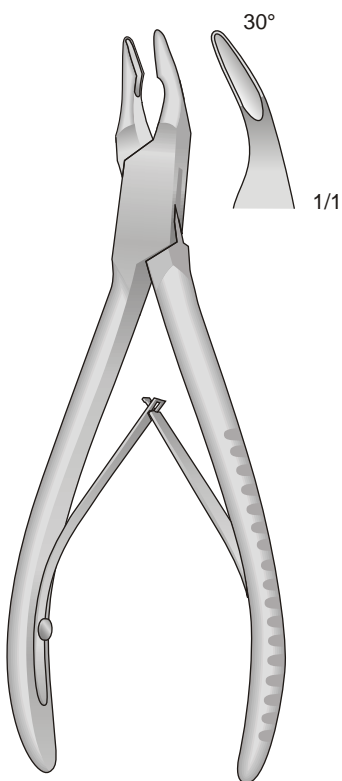

**BLUMENTHAL**  
**FO-19**  
150 mm

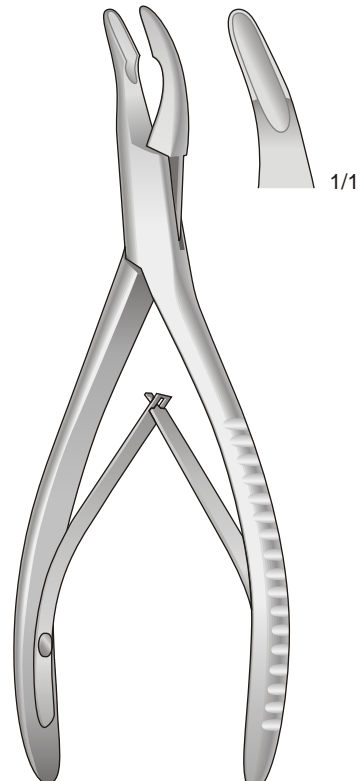

**MEAD**  
**FO-21**  
165 mm

Hohlmeißelzangen

Bone rongeurs

Pinze ossivore

Pinza-gubias

Pinces-gouges

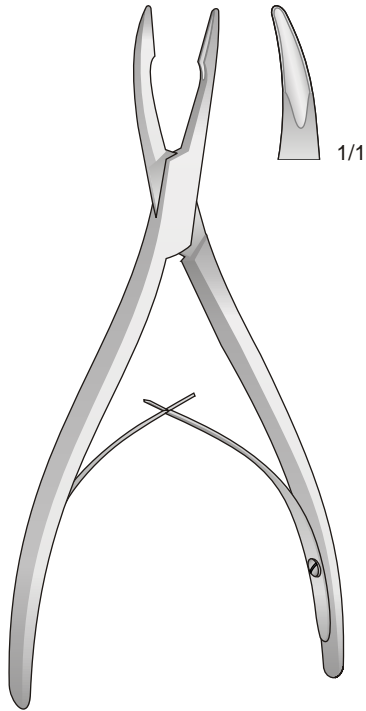

FRIEDMANN  
**FO-16**  
160 mm

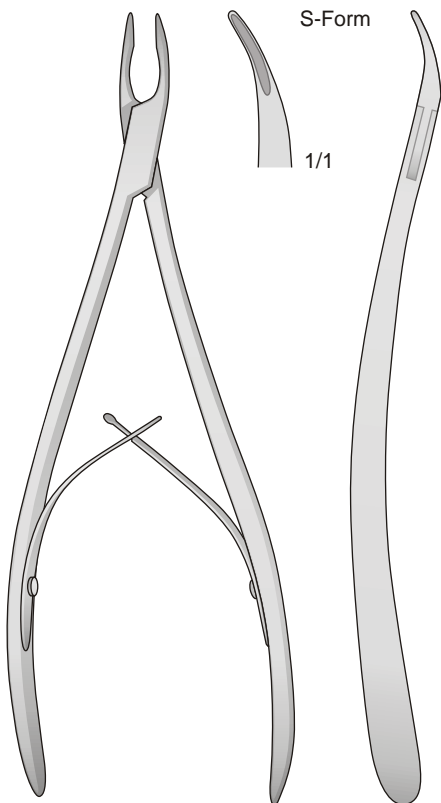

STELLBRINK  
**FO-87**  
190 mm

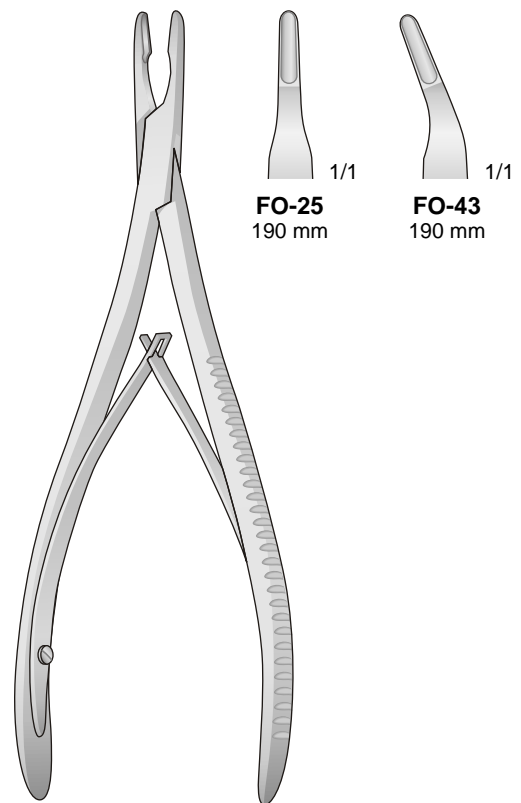

LEMPERT  
**FO-25/FO-43**  
190 mm

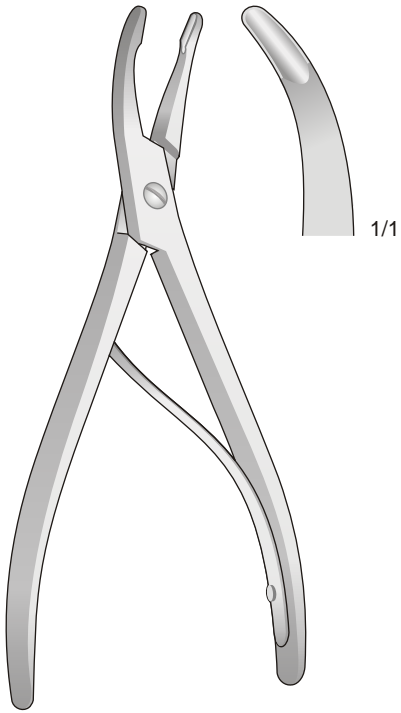

**LUER**  
**FO-18**  
155 mm

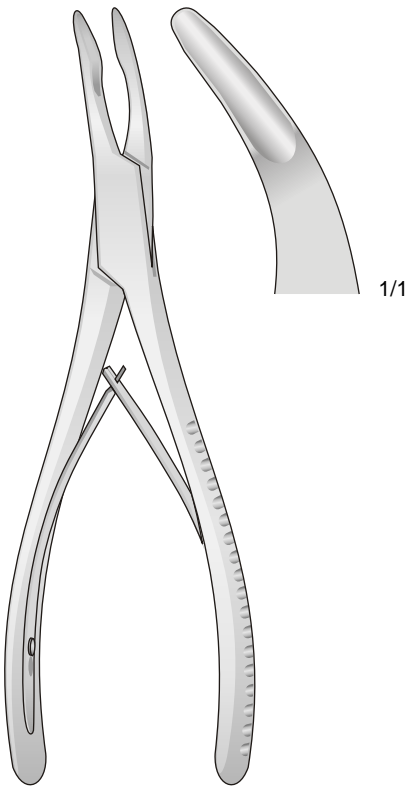

**OLIVECRONA**  
**FO-45**  
190 mm

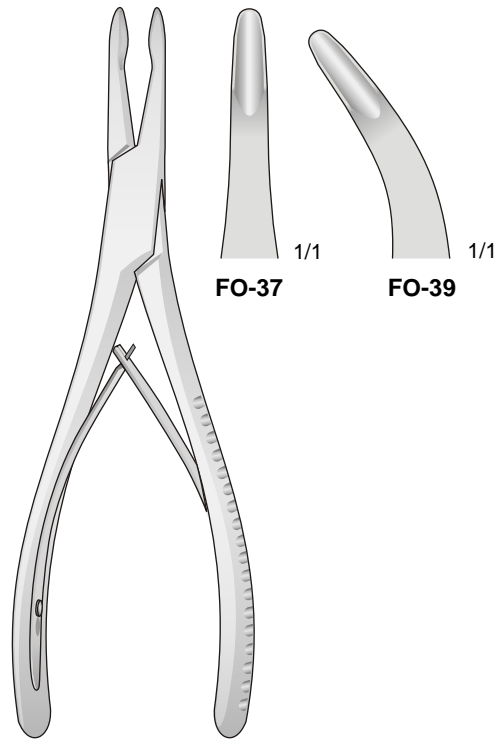

**JANSEN**  
**FO-37/FO-39**  
170 mm

Hohlmeißelzangen

Bone rongeurs

Pinze ossivore

Pinza-gubias

Pinces-gouges

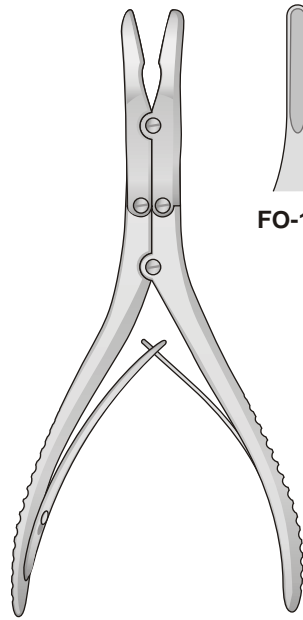

**FO-138**

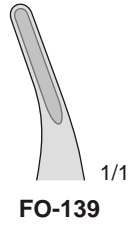

**FO-139**

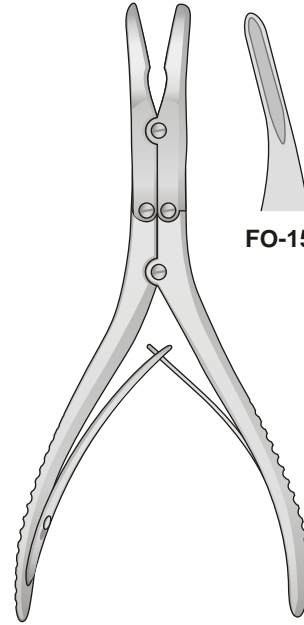

**FO-156**

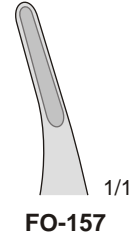

**FO-157**

**RUSKIN**  
**FO-138/FO-139**  
150 mm

**KLEINERT-KUTZ**  
**FO-156/FO-157**  
155 mm

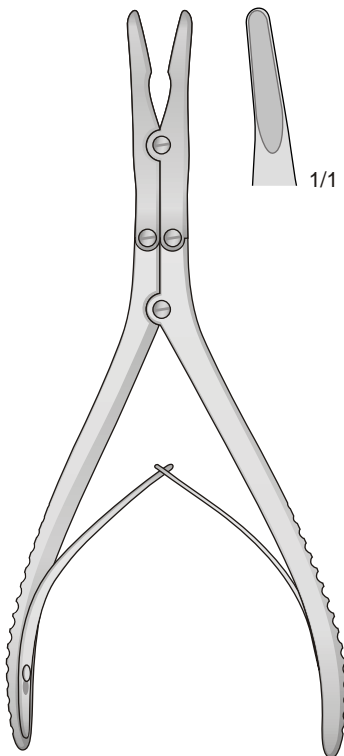

**BEYER**  
**FO-20**  
180 mm

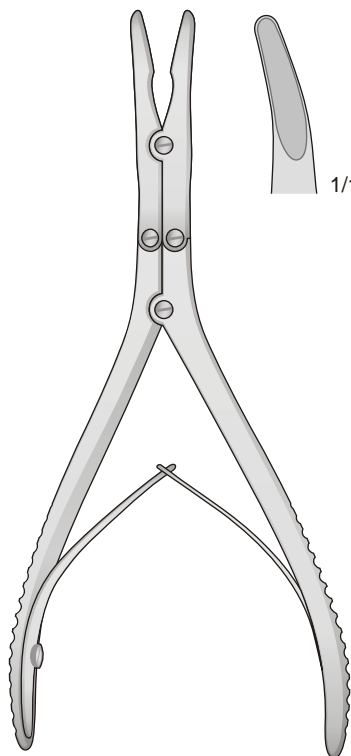

**ZAUFAL-JANSEN**  
**FO-34**  
180 mm

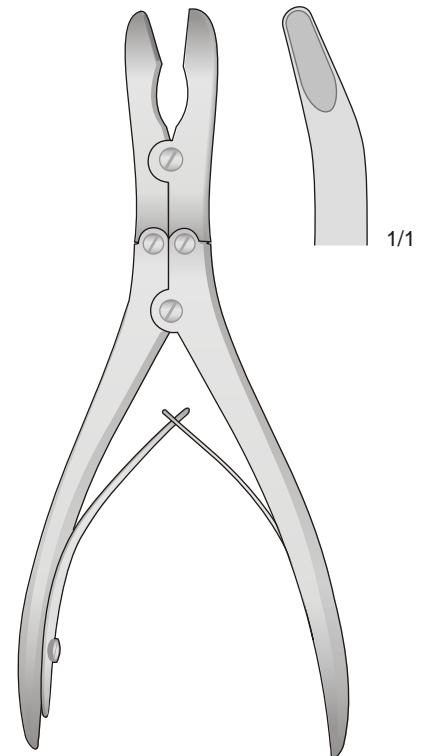

**RUSKIN-STILLE**  
**FO-35**  
180 mm

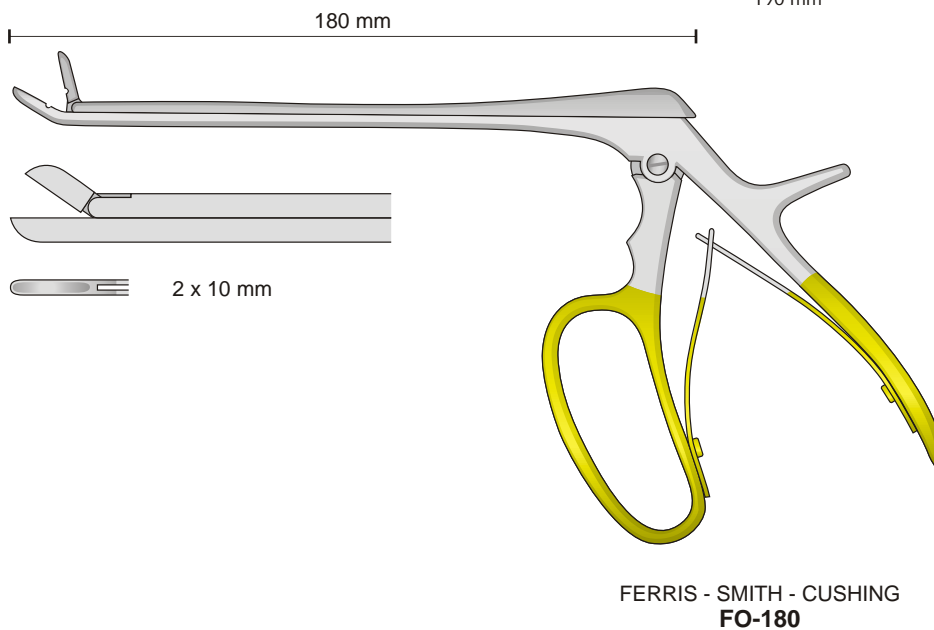
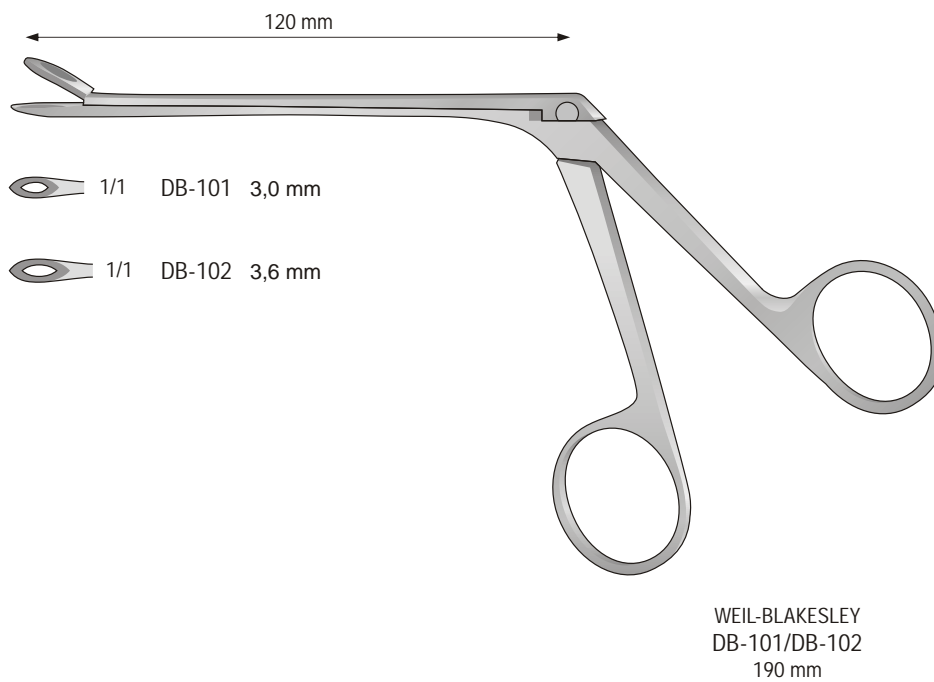
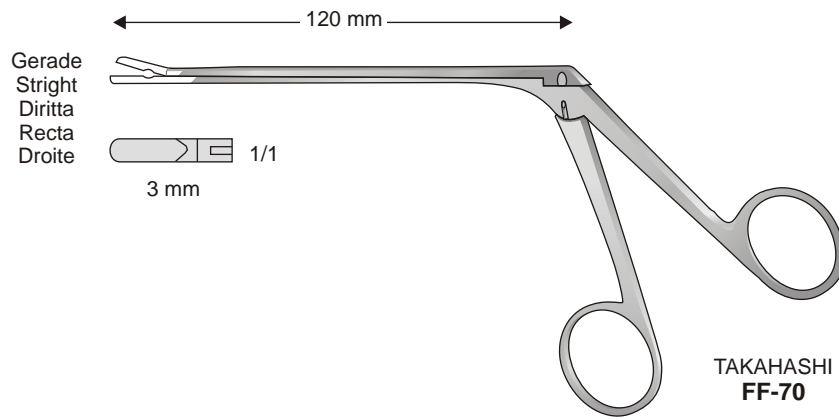

Pinze ossivore

Bone Cutting Forceps

Knochensplitterzangen

Pincès coupantes à os

Pinza cortante para huesos

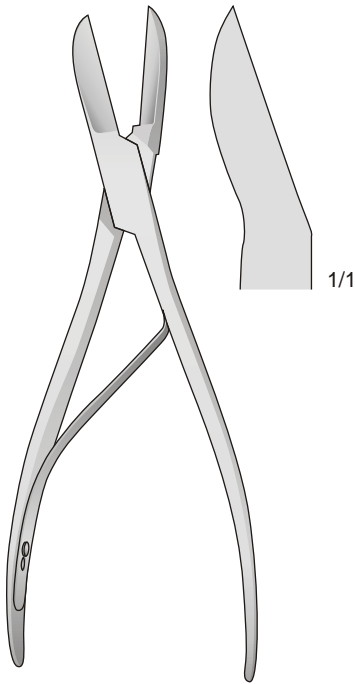

**LISTON  
LX-109**  
170 mm

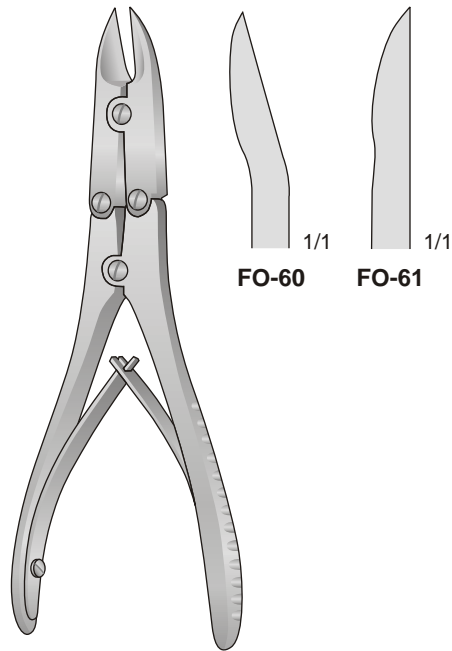

**BÖHLER  
FO-60/FO-61**  
150 mm

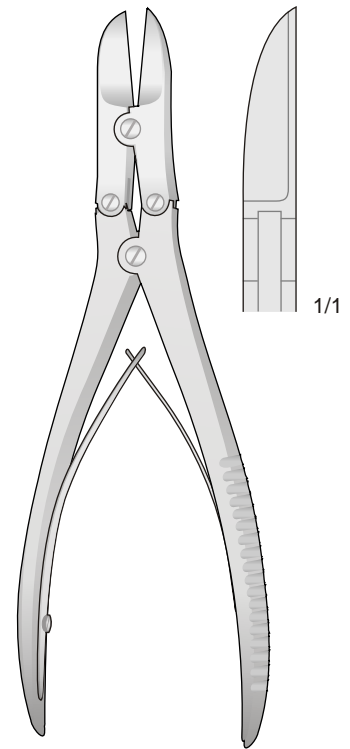

**RUSKIN-LISTON  
FO-108**  
190 mm

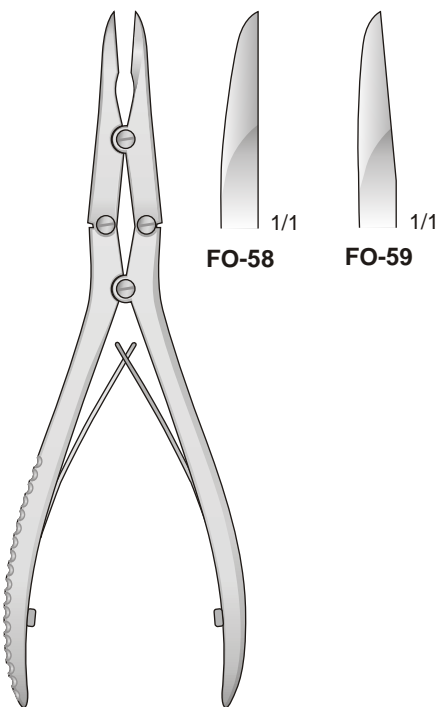

**FO-58/FO-59**  
180 mm

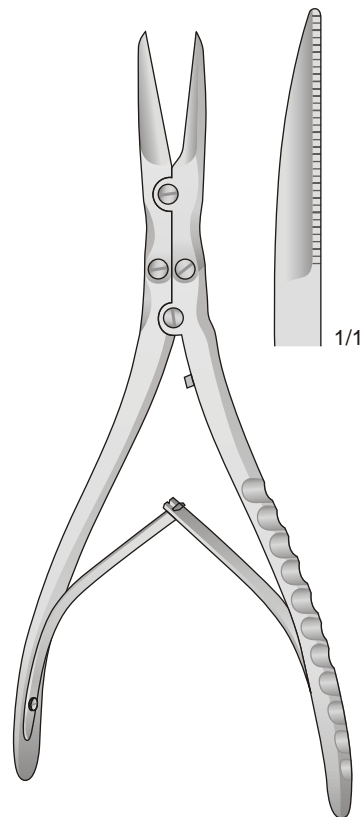

**FO-146**  
215 mm

Zange mit Zahnsperre  
 Forceps with ratchet fixation  
 Pinza con cremagliera  
 Davier à crémaillère

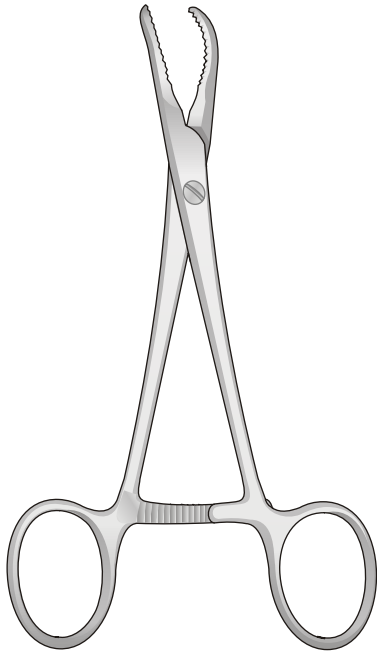

**FO-47**  
140 mm

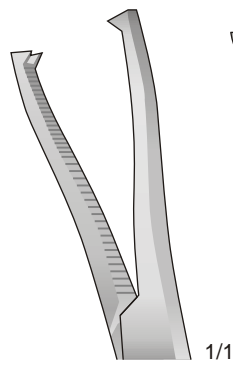

**DINGMANN**  
**FO-130**

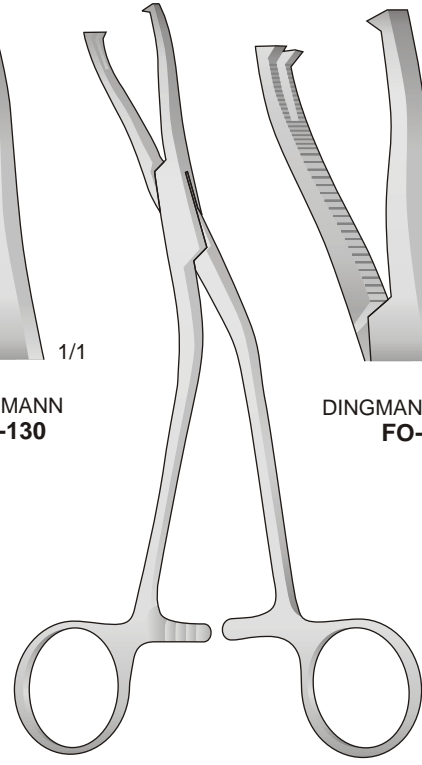

**DINGMANN**  
**FO-130/FO-131**  
190 mm

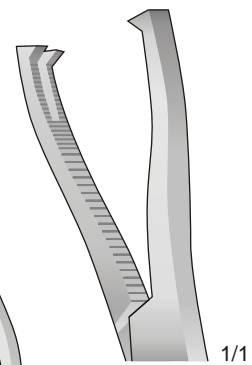

**DINGMANN MODIF.**  
**FO-131**

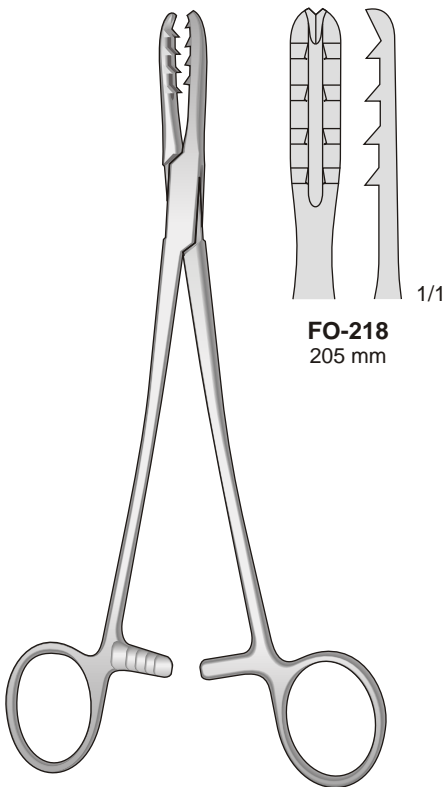

**BIRCHER-GANSKE**  
**FO-218**  
205 mm

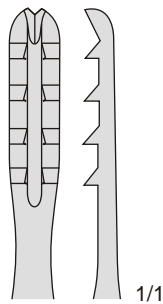

**FO-218**  
205 mm

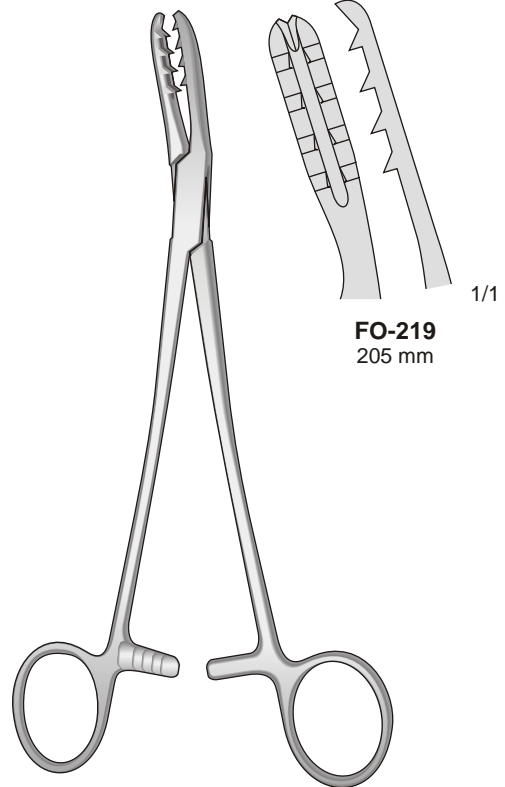

**BIRCHER-GANSKE**  
**FO-219**  
205 mm

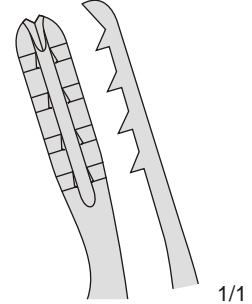

**FO-219**  
205 mm



Drahtschneidezangen

Wire cutting pliers

Tronchesi per fili  
metallici

Cortador de agujas  
kirschner

Pinces à couper le fil

Für weichen Draht Ø 2 mm  
Für harten Draht Ø 1,5 mm  
For soft wire Ø 2 mm  
For hard wire Ø 1,5 mm  
Per filo leggero Ø 2 mm  
Per filo duro Ø 1,5 mm  
Para alambres ligero Ø 2 mm  
Para alambres duro 1,5 mm  
Pour fil léger Ø 2 mm  
Pour fil dur Ø 1,5 mm

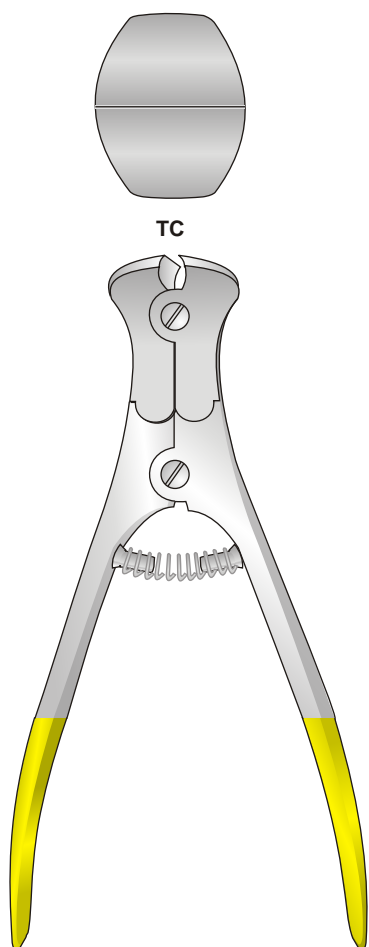

**LX-102**  
145 mm

Für weichen Draht Ø 2 mm  
Für harten Draht Ø 1,6 mm  
For soft wire Ø 2 mm  
For hard wire Ø 1,6 mm  
Per filo leggero Ø 2 mm  
Per filo duro Ø 1,6 mm  
Para alambres ligero Ø 2 mm  
Para alambres duro Ø 1,6 mm  
Pour fil léger Ø 2 mm  
Pour fil dur Ø 1,6 mm

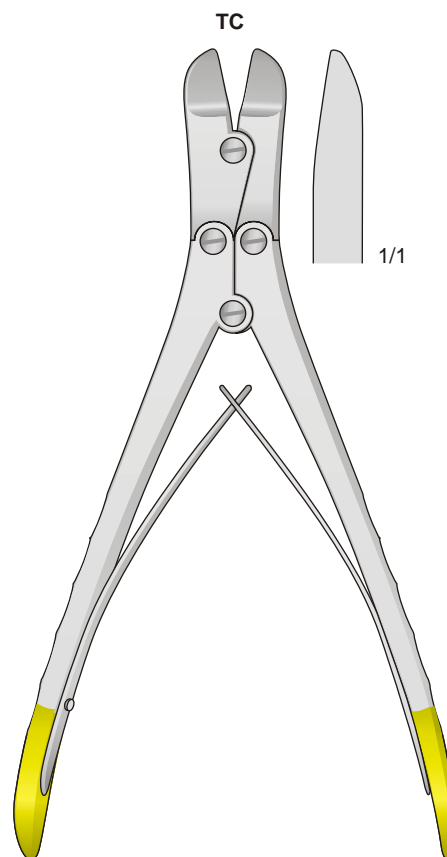

**LX-103**  
170 mm

Extraktionszangen  
für Bohrdrähte

Extraction pliers  
for boring wires

Pinze per estrazione  
fili metallici

Pinzas para extracción  
de hilo metálico

Pinces pour  
l'extraction des broches

Draht-und Bleischere gezahnt - Wire cutting scissor serrated  
Forbice universale dentellata - Tijeras para cortar hilo de acero dentadas  
Ciseaux à couper les fils métalliques

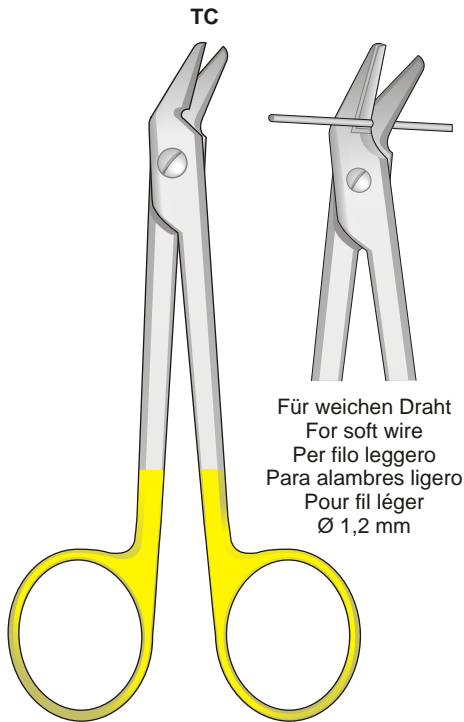

**DP-120**  
120 mm

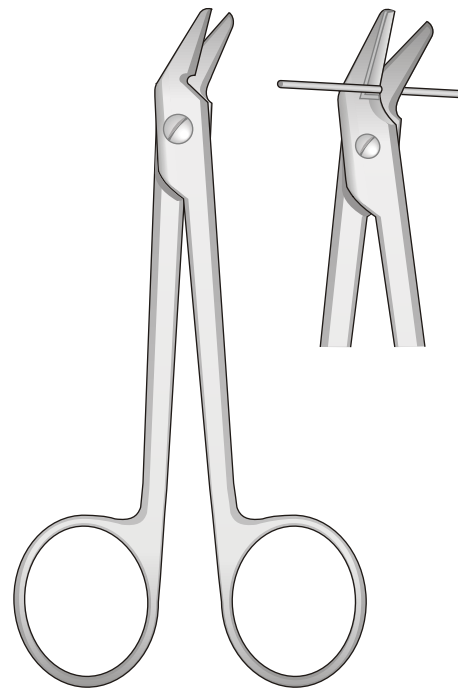

**DP-90**  
120 mm

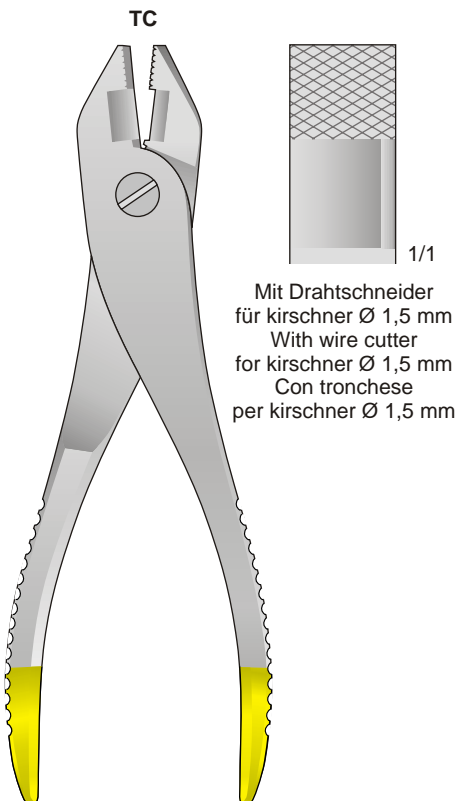

**LX-125**  
220 mm

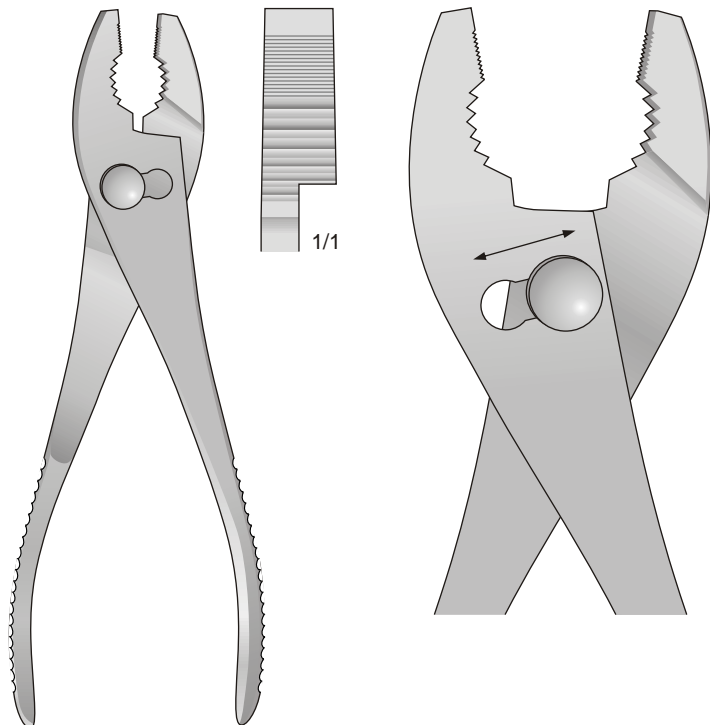

**VH-40**  
200 mm

Extraktionszangen  
für Bohrdrähte

Extraction pliers  
for boring wires

Pinze per estrazione  
fili metallici

Pinzas para extracción  
de hilo metálico

Pinces pour  
l'extraction des broches

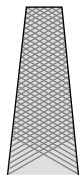

1/1

**VH-20**

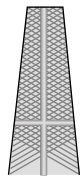
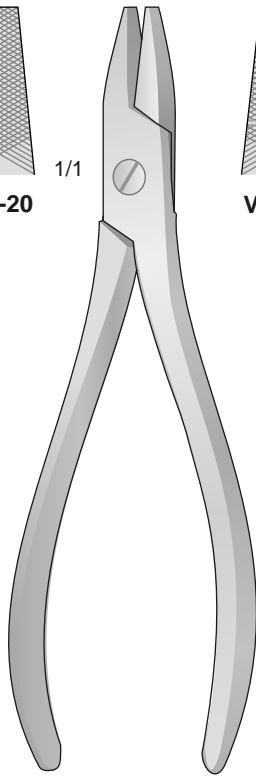

1/1

**VH-21**

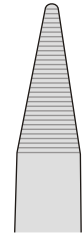
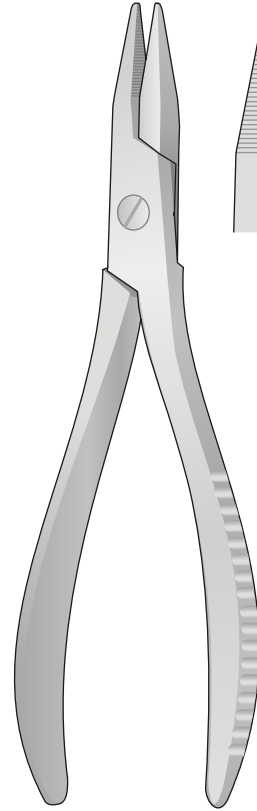

1/1

**VH-20/VH-21**  
175 mm

**VH-23**  
190 mm

2,5 mm

3,5 mm

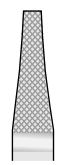

1/1

**LX-138**  
150 mm

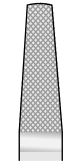

1/1

**LX-139**  
180 mm

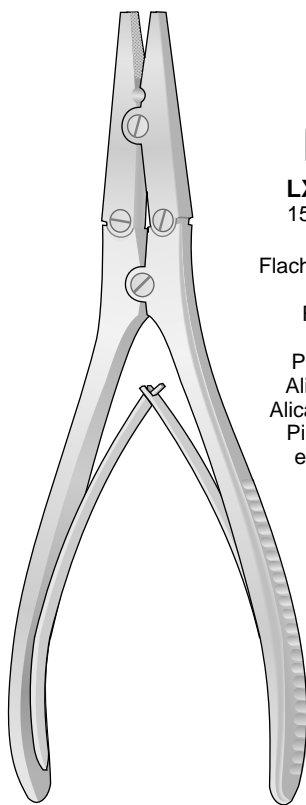

**LX-138/LX-139**

Flachzange, Extraktionszange  
für Bohrdrähte  
Flat pliers, Extraction  
pliers for wires  
Pinze per estrazione fili  
Alicates para extracción,  
Alicates para sacar alambre  
Pince plate, Pinces pour  
extraction des broches

**TC**

3 mm

6 mm

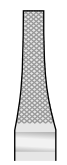

1/1

**LX-140**  
180 mm

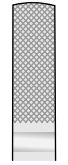

1/1

**LX-141**  
180 mm

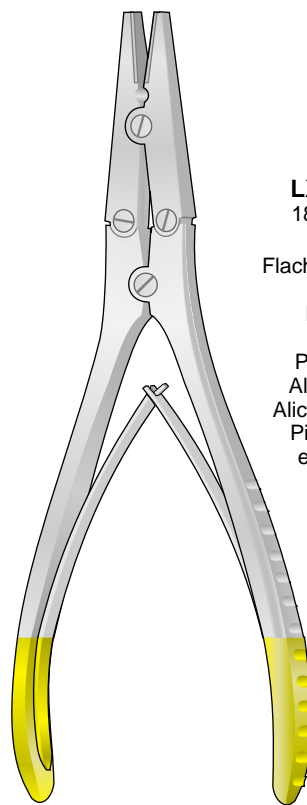

**LX-140/LX-141**

Flachzange, Extraktionszange  
für Bohrdrähte  
Flat pliers, Extraction  
pliers for wires  
Pinze per estrazione fili  
Alicates para extracción,  
Alicates para sacar alambre  
Pince plate, Pinces pour  
extraction des broches

Für Kinder  
For children  
Per bambini  
Para niños  
Pour enfants

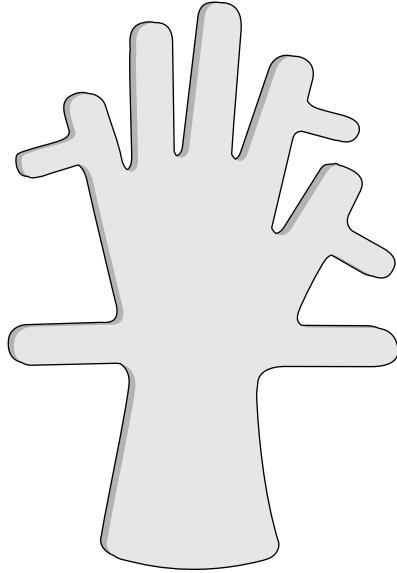

**FO-299**

Für Erwachsene - For adults - Per adulti  
Para adultos - Pour adultes

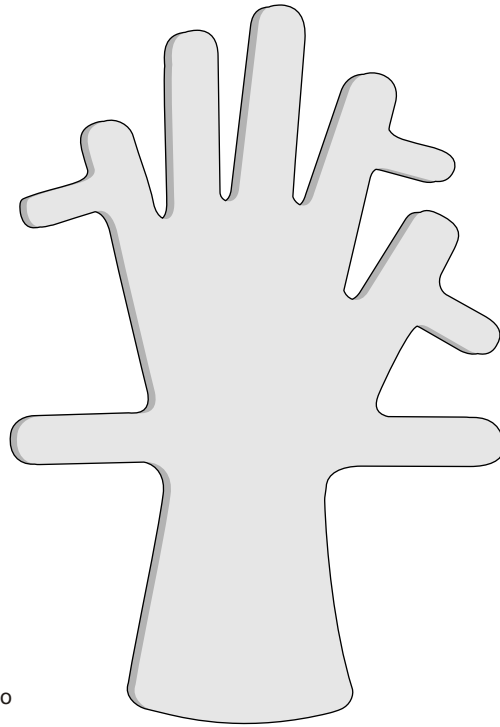

**FO-300**

Bleihände  
Lead hands  
Mani di piombo  
Manos de plombo  
Main de plomb

Nagel -Ausreisszange  
Nail extracting forceps  
Pinza per estrazione delle unghie  
Pinzas para arrancar uñas  
Pince pour extraire les ongles

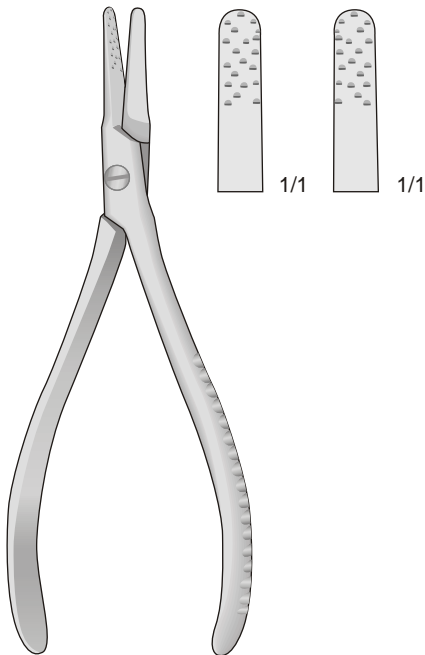

**RADOLF  
FO-159  
135 mm**

Nagelspaltzange  
Nail nipper  
Pinza per unghie  
Pinzas corta uñas  
Pince à ongles

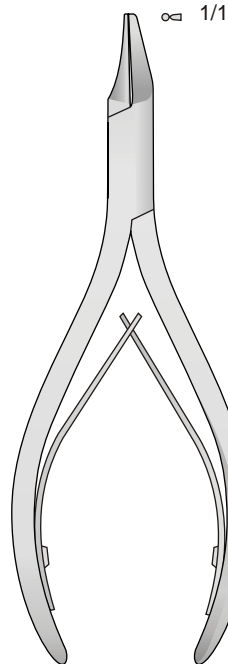

**DP-09  
135 mm**

Repositionszangen

Reposition forceps

Pinze per riposizione

Pinzas para reducciòn

Pinces de reposition

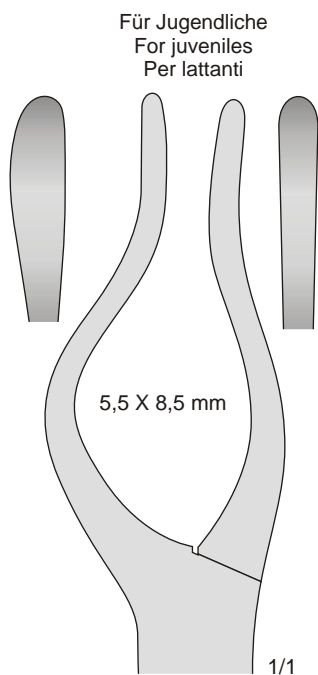

**DO-10 L**  
**DO-11 R**  
225 mm

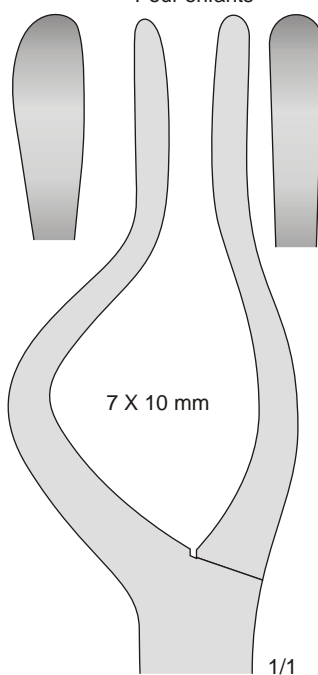

**DO-12 L**  
**DO-13 R**  
235 mm

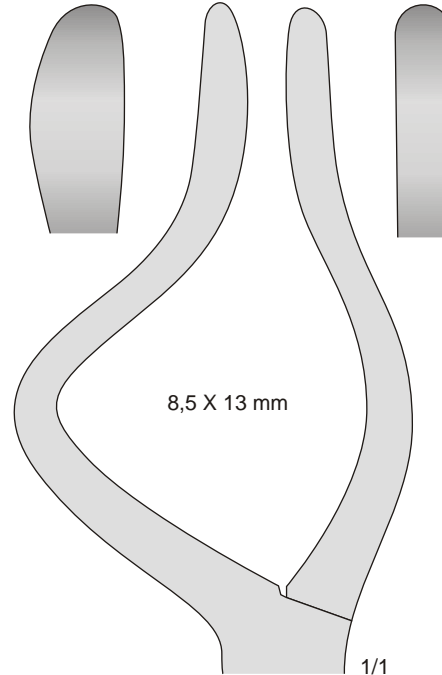

**DO-14 L**  
**DO-15 R**  
240 mm

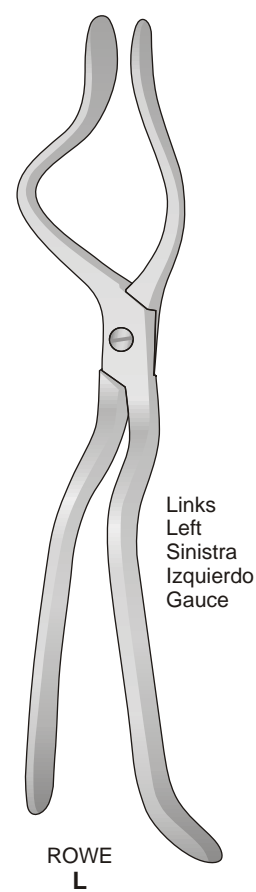
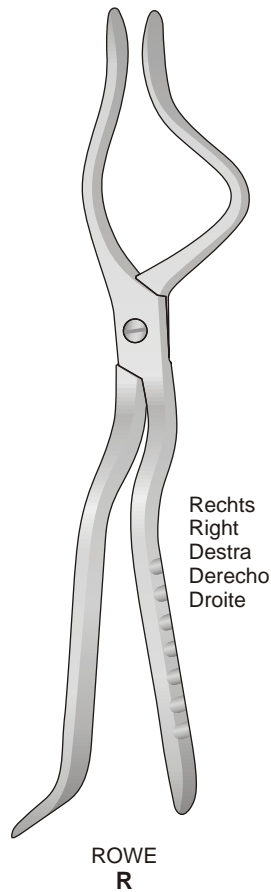
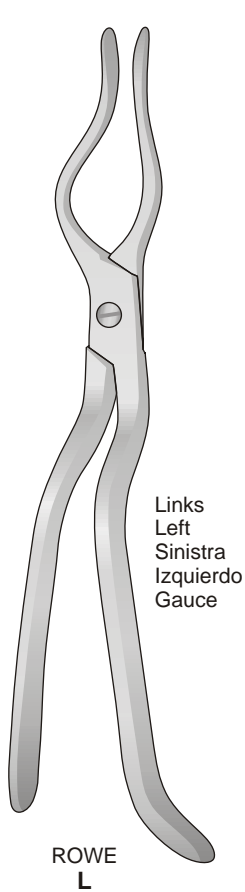
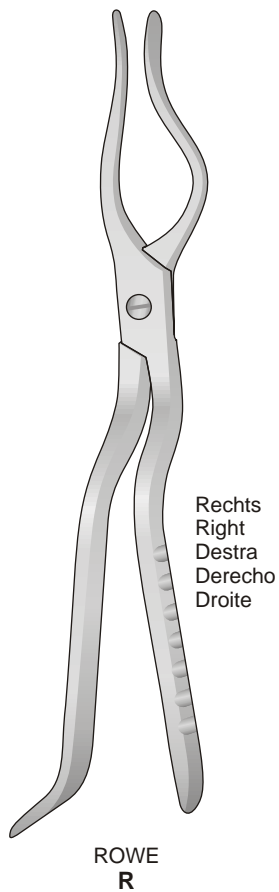

Rhinologie  
Septumzangen

Rhinology  
Septum Forceps

Rinologia  
Pinze per setto nasale

Rinología  
Pinzas para tabique  
nasal

Rhinologie  
Pincers pour la cloison  
nasale

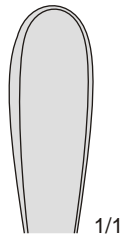
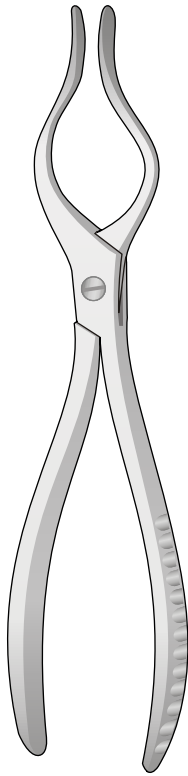

**DO-147**

Links  
Left  
Sinistra  
Izquierdo  
Gauce

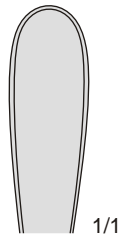

**DO-148**

Gerade  
Straight  
Diritto  
Recto  
Droite

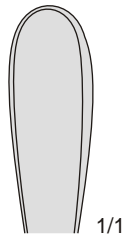

**DO-149**

Rechts  
Right  
Destra  
Derecho  
Droite

**COTTLE-WALSHAM**  
**DO-147/DO-149**  
230 mm

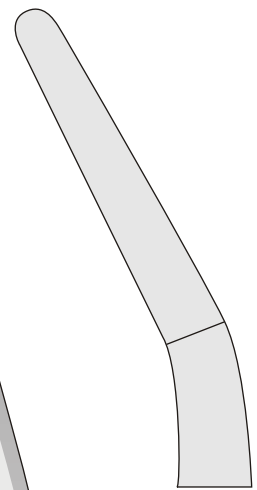
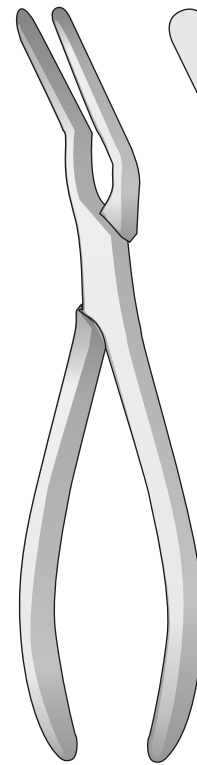

1/1

**ASCH**  
**DO-157**  
230 mm

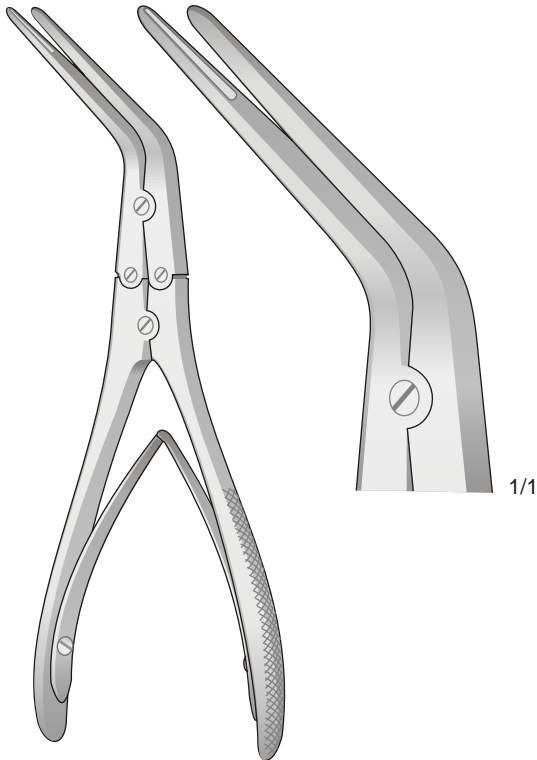

**KRESSNER**  
**FO-141**  
200 mm

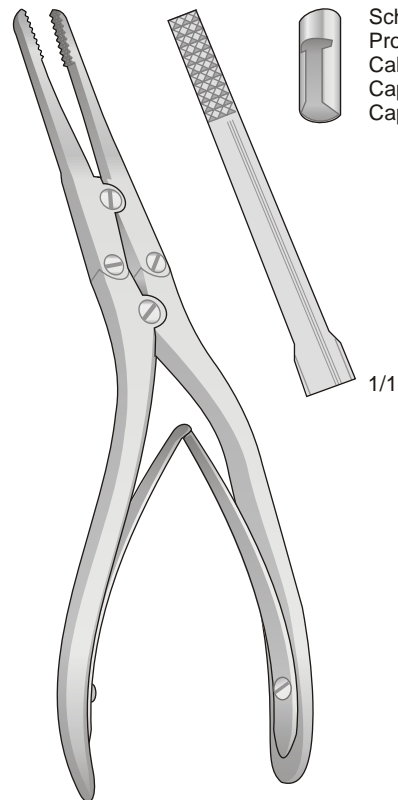

**RUBIN**  
**FO-142**  
210 mm



Schutzkappe  
Protection Cap  
Calotta protettiva  
Caperuza protectora  
Capuchon protecteur

1/1

Rhinologie

Rhinology

Rinologia

Rinología

Rhinologie

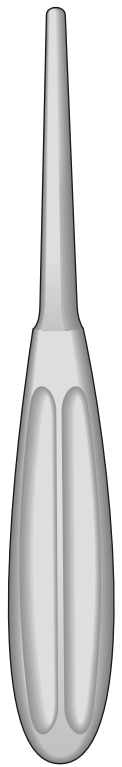

Stumpf  
Blunt  
Smussa  
Romo  
Mousse

Septumfraktur-Elevatorium  
Septum Displacer  
Elevatore per fratture del setto  
Elevador para fracturas  
del tabique nasal  
Élévateur pour fractures  
de la cloison nasale

**GOLDMANN  
DO-288**  
200 mm

10 mm

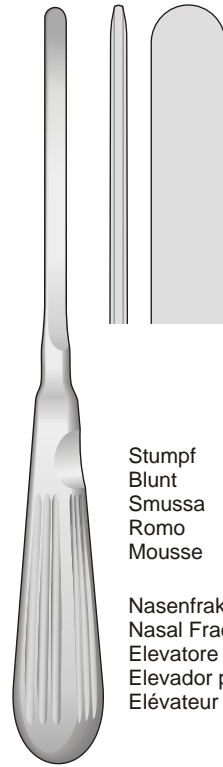

Stumpf  
Blunt  
Smussa  
Romo  
Mousse

Nasenfraktur-Elevatorium  
Nasal Fracture Elevator  
Elevatore per fratture nasali  
Elevador para fracturas nasales  
Élévateur pour fractures nasales

**BOIES  
DO-289**  
200 mm

Septum bone cutting and  
breaking forceps curved to the left,  
sharp spoons

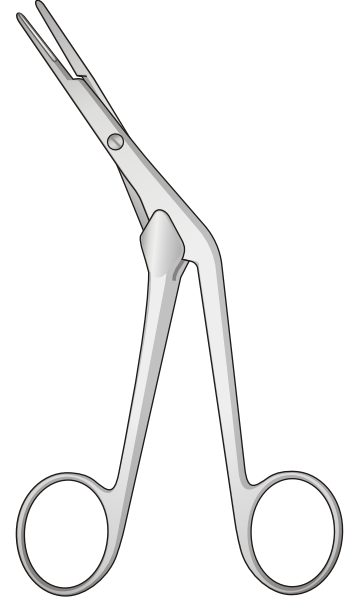

**CRAIG  
FO-490**  
165 mm

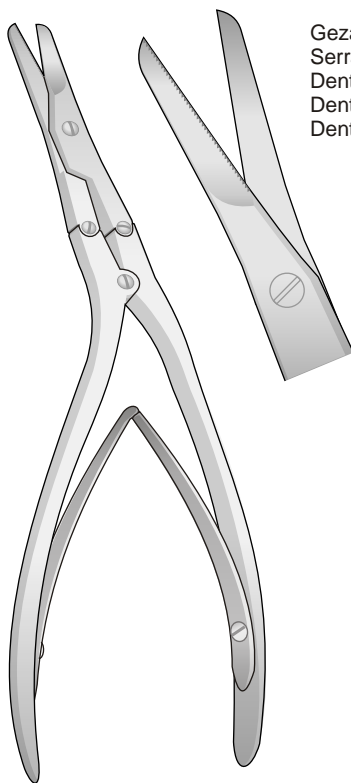

Gezahnt  
Serrated  
Dentellata  
Dentada  
Dentéle

1/1

**CAPLAN  
FO-144**  
200 mm

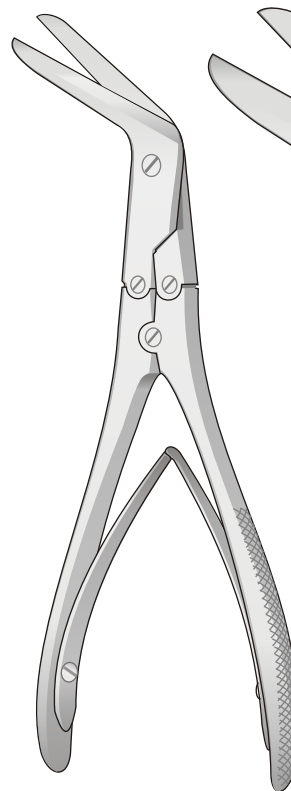

**KILLIAN  
FO-143**  
210 mm

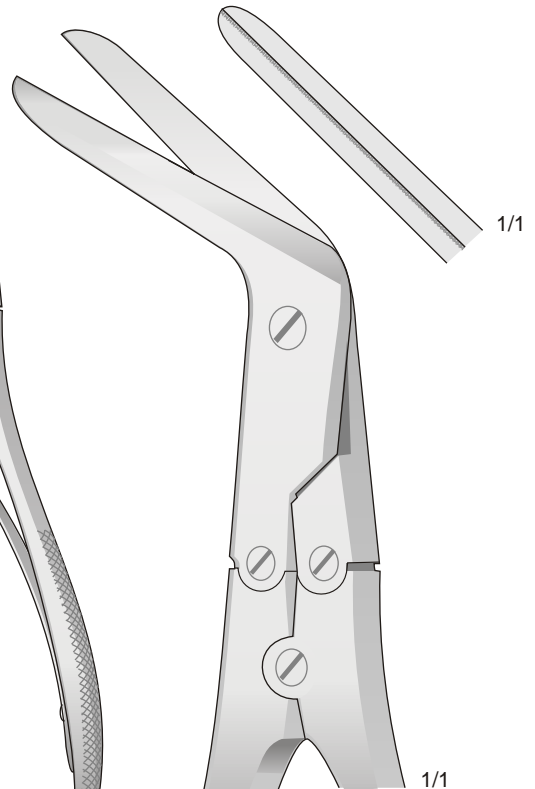

1/1

1/1







**SADIQ SURGICAL CO.**

Catalogue 2015 / 2016



## Plastic Surgery

11

Saugkanülen, Nagelzangen  
Suction Tubes, Nail Nippers  
Cannule per aspirazione, Tronchesi per unghie Cánulas de aspiración, Pinzas para uñas Canules d'aspiration Pincés pour ongles



Saugkanülen

Suctions tubes

Cannule per aspirazione

Cánulas de aspiración

Canules aspiratrices



Saugkanülen

Suctions tubes

Cannule per aspirazione

Cánulas de aspiración

Canules aspiratrices

Rostfrei  
Stainless steel  
Acciaio chirurgico  
Acero  
Acier

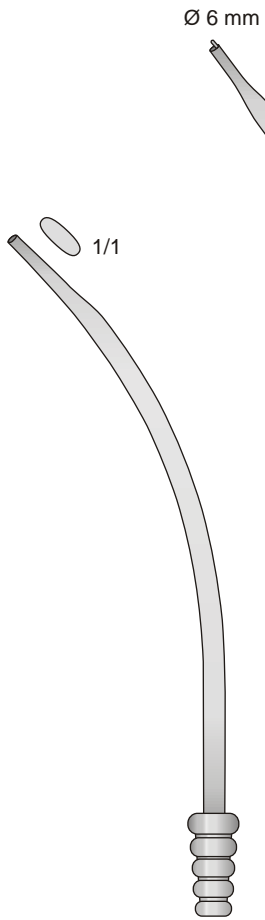

**GF-20**  
180 mm

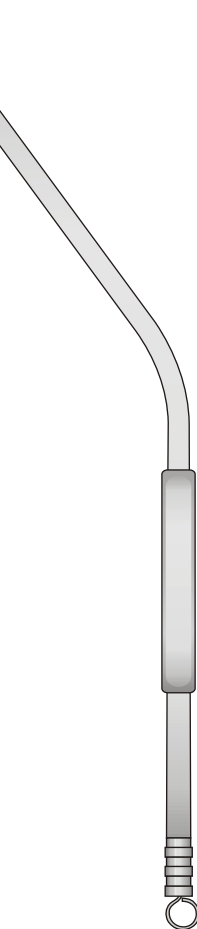

**GF-104**  
240 mm



**GF-110**  
230 mm

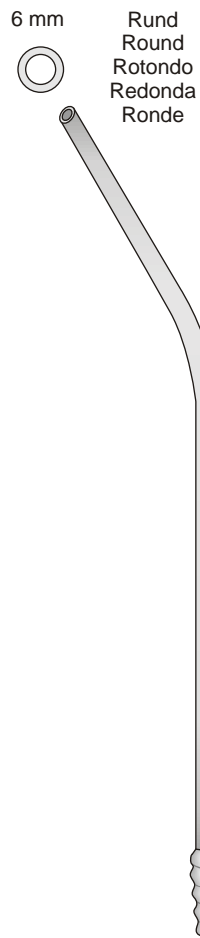

**NUBOER**  
**GF-98**  
210 mm



**NUBOER**  
**GF-99**  
210 mm

Saugkanülen

Suctions tubes

Cannule per aspirazione

Cánulas aspiradoras

Canules aspiratrices

Saugraspatorium Scharf - Raspatories, Scharp  
 Raschietti taglienti - Raspador cortante - Rugine tranchante

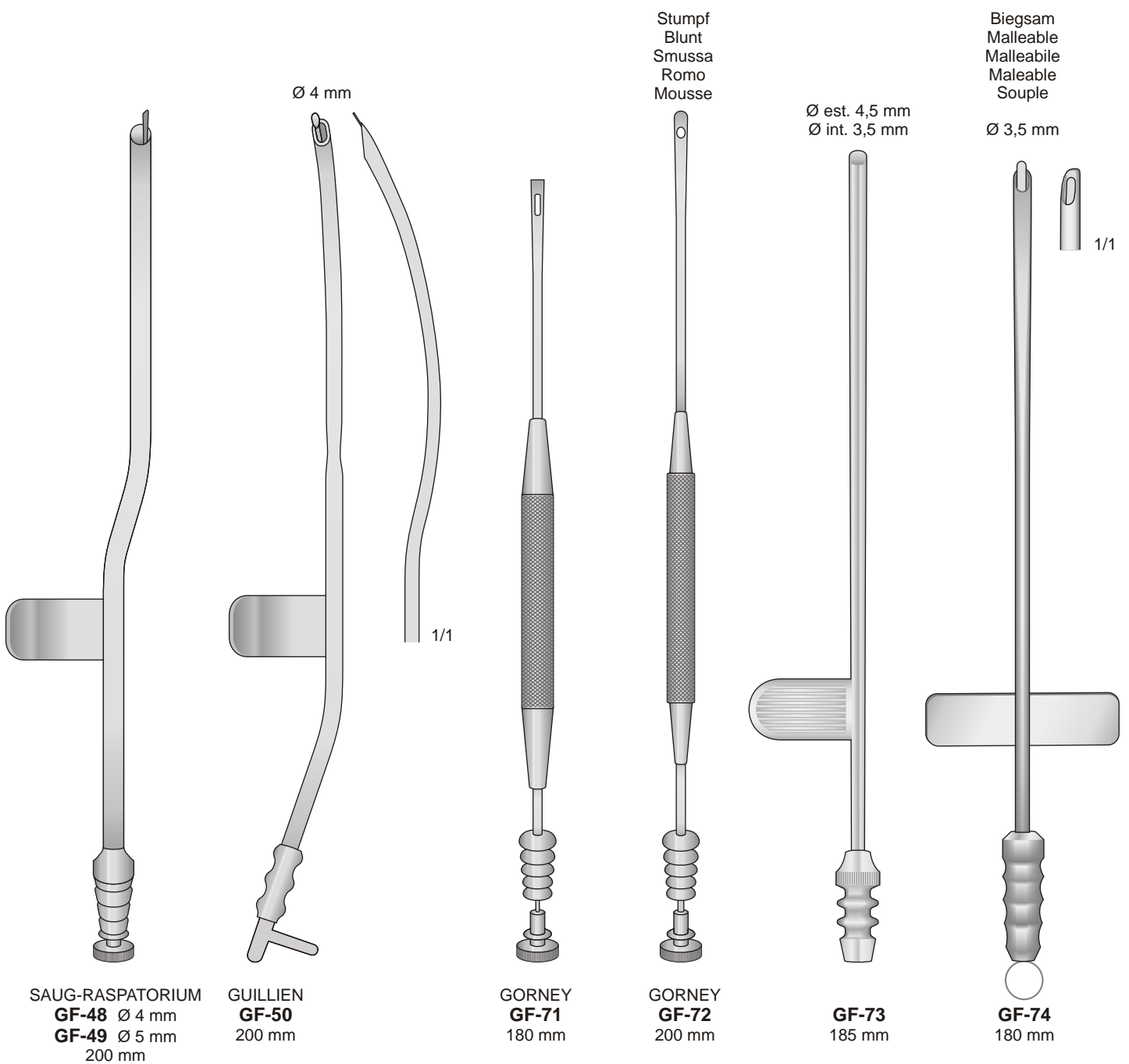

Saugkanülen

Suctions tubes

Cannule per aspirazione

Cánulas aspiradoras

Canules aspiratrices

Char. 6	= 2 mm
Char 7	= 2,5 mm
Char 9	= 3 mm
Char 10	= 3,3 mm
Char 12	= 4 mm
Char 15	= 5 mm

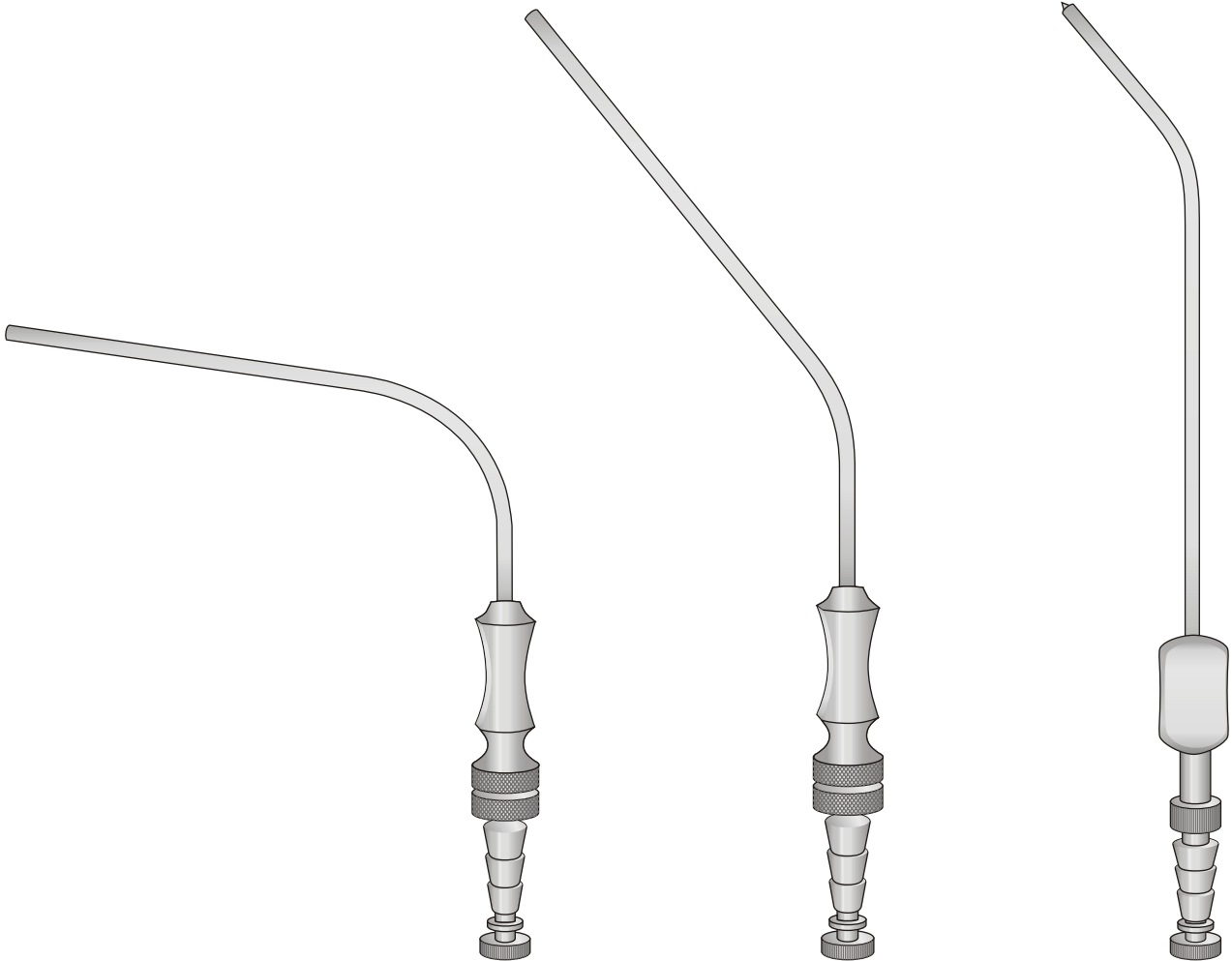

**FERGUSSON**  
**GF-140** Ch. 6  
**GF-141** Ch. 7  
**GF-142** Ch. 9  
**GF-143** Ch. 12  
**GF-144** Ch. 15  
 180 mm

**FRAZIER**  
**GF-240** Ch. 6  
**GF-241** Ch. 7  
**GF-242** Ch. 9  
**GF-243** Ch. 12  
**GF-244** Ch. 15  
 180 mm

**PLESTER**  
**GF-150** Ch. 6  
**GF-151** Ch. 7  
**GF-152** Ch. 9  
**GF-153** Ch. 12  
**GF-154** Ch. 15  
 200 mm

Saugkanülen

Suctions tubes

Cannule per aspirazione

Cánulas aspiradoras

Canules aspiratrices

Char. 3	= 1 mm
Char. 5	= 1,7 mm
Char. 7	= 2,5 mm
Char. 10	= 3,3 mm
Char. 12	= 4 mm

Mit Unterbrecherplatte  
 With finger cut-off  
 Con placca d'interruzione  
 Con placa desconectadora  
 Avec plaque interruptrice

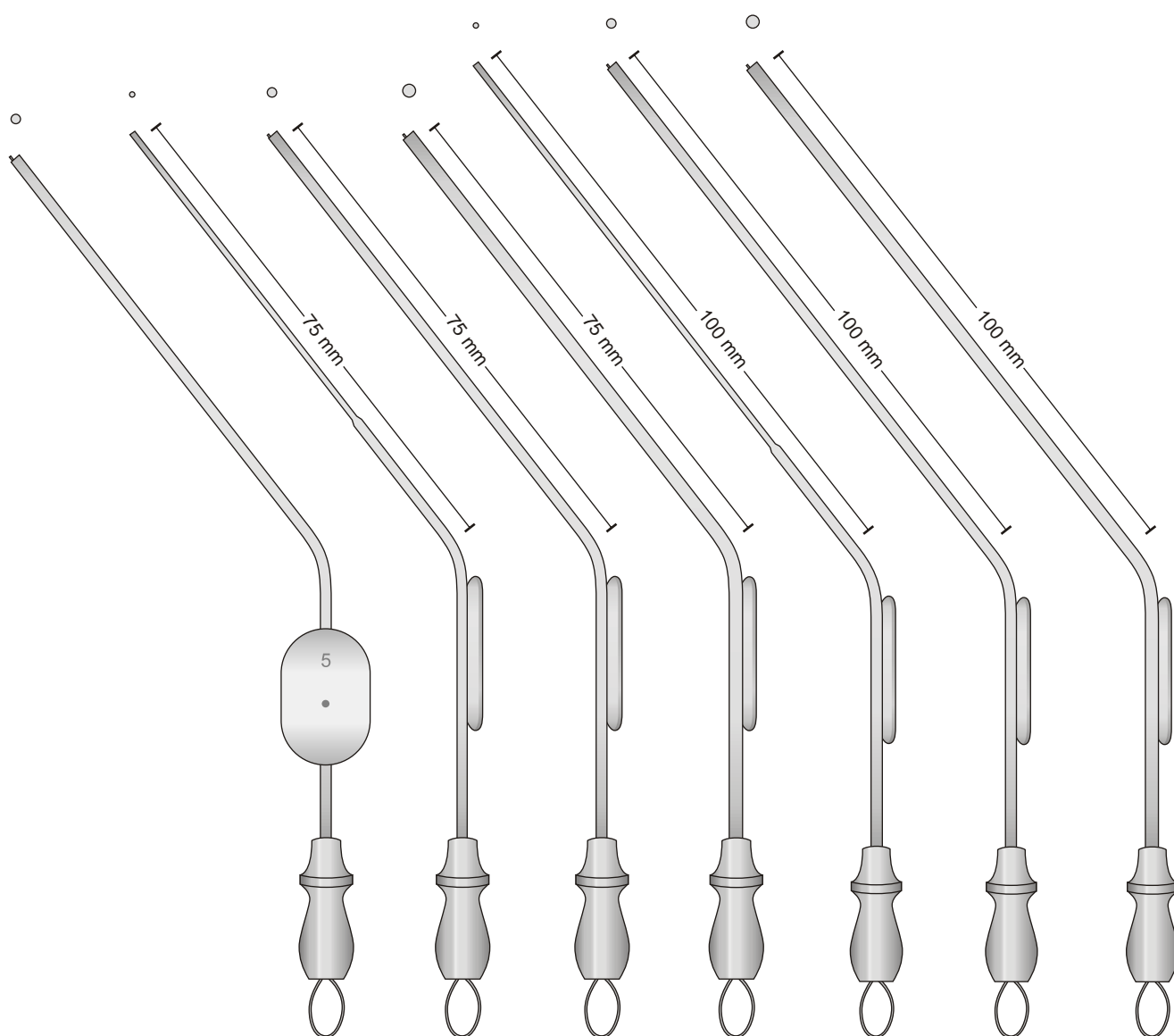

**BELLUCCI  
GF-232**  
Charr. 5

**BARON  
GF-43**  
Charr. 3

**BARON  
GF-45**  
Charr. 5

**BARON  
GF-47**  
Charr. 7

**BARON  
GF-63**  
Charr. 3

**BARON  
GF-65**  
Charr. 5

**BARON  
GF-67**  
Charr. 7

House Saug- und Spülrohr, Luer Konus

Saugrohr  
Suction tube  
Tubo per aspirazione  
Tube d'aspiration

Spülrohr  
Irrigation tube  
Tubo per irrigazione  
Tube d'irrigation

Char. 3	= 1 mm
Char 5	= 1,7 mm
Char 7	= 2,5 mm
Char 10	= 3,3 mm
Char 12	= 4 mm
Char 14	= 4,6 mm

Char. 2	= 0,6 mm
Char 4	= 1,21 mm
Char 5	= 1,7 mm
Char 7	= 2,5 mm
Char 8	= 2,4 mm
Char 12	= 4 mm

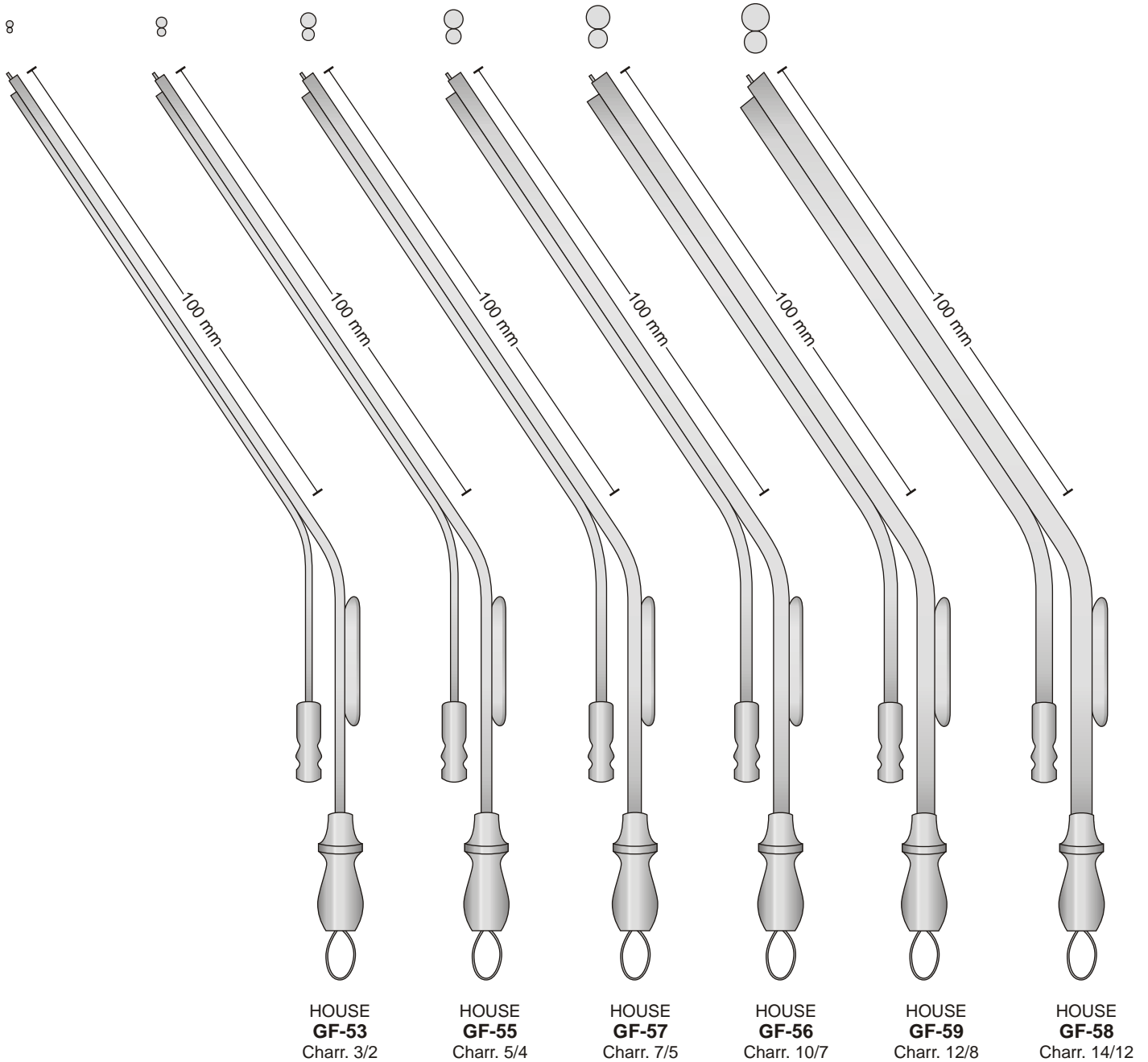



Saugkanülen

Suctions tubes

Cannule per aspirazione

Cánulas aspiradoras

Canules aspiratrices

Oberfläche Geschwärzt  
Surface Black-finish  
Superficie colorata nera  
Surface noircie

Oberfläche Geschwärzt  
Surface Black-finish  
Superficie colorata nera  
Surface noircie

Biegsam  
Malleable  
Malleabile  
Malleable  
Malléables  
Ø 3 mm

Biegsam  
Malleable  
Malleabile  
Malleable  
Malléables  
Ø 3 mm

Biegsam  
Malleable  
Malleabile  
Malleable  
Malléables  
Ø 3 mm

Biegsam  
Malleable  
Malleabile  
Malleable  
Malléables  
Ø 3 mm

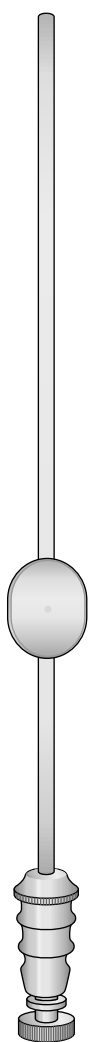

WERTHEIMER  
**GF-69**  
160 mm

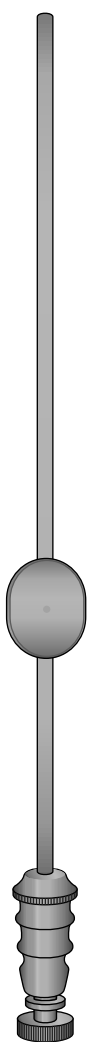

FRAZIER  
**GF-70**  
160 mm

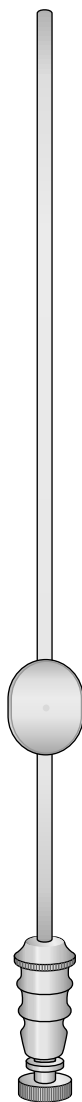

WERTHEIMER  
**GF-60**  
200 mm

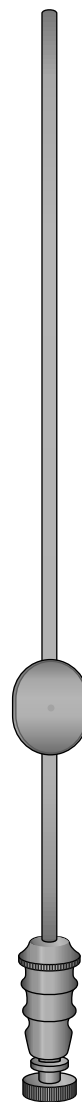

FRAZIER  
**GF-61**  
200 mm

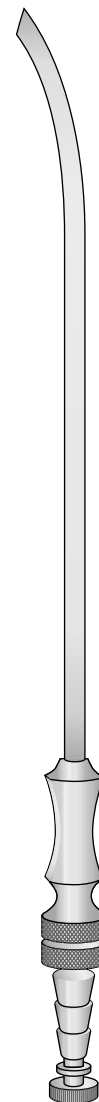

ADSON  
**GF-41** ch. 12 = Ø 4 mm  
**GF-42** ch. 15 = Ø 5 mm  
210 mm

**GF-97**  
 Komplettsset mit:  
 Set complete with:  
 Set completo con:  
 Set completos con:  
 Set complet avec:  
**GF-92 - GF-93 - GF-94 - GF-96**

Gummiball - Rubber bulb  
 Pompetta in gomma - Pera de goma  
 Poire en caoutchouc

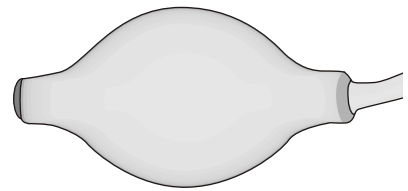

**GF-96**

Schlauch - Silikon  
 Flexible tube - Silicone  
 Raccordo in silicone per cannule  
 Autoclavabile  
 Tubo flexible de silicona  
 Tuyau - Silicone

2 mt.

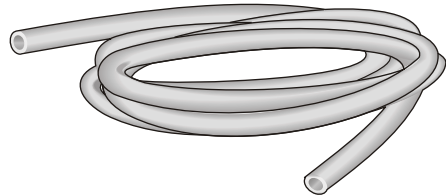

**TS-50**  
 2 mt.

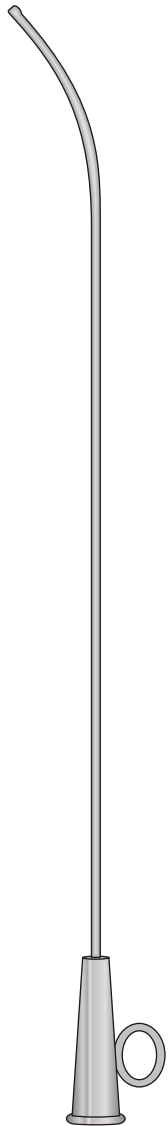

HARTMANN  
**GF-111/GF-113**  
 170 mm

**GF-111** - Ø 1,5 mm  
**GF-112** - Ø 2 mm  
**GF-113** - Ø 2,5 mm

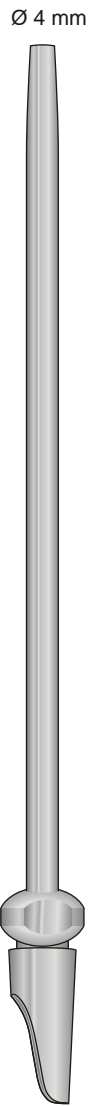

**GF-94**  
 160 mm

Ø 4 mm

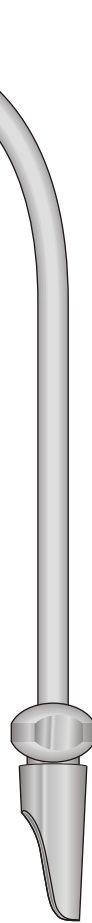

**GF-93**  
 145 mm

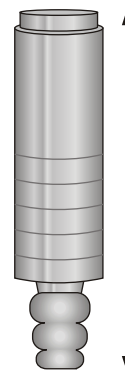

**GF-92**  
 65 mm

65 mm

Saugkanülen

Suctions tubes

Cannule per aspirazione

Cánulas aspiradoras

Canules aspiratrices

Kiefer und Stirnhöhlen-Spülkanülen  
Antrum and frontal sinus wash cannulas  
Cannule per lavaggio dei seni frontali e mascellari  
Cánulas lavadores para seno maxilar y seno frontal  
Canules pour le lavage du sinus maxillaire et frontal

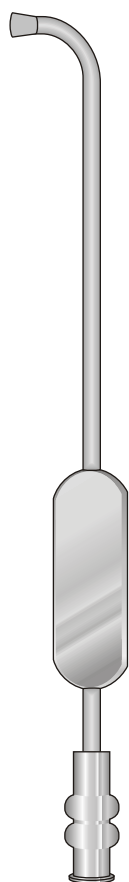

**KILLIAN**  
**GF-85** Ø 3 mm  
**GF-87** Ø 4 mm  
145 mm

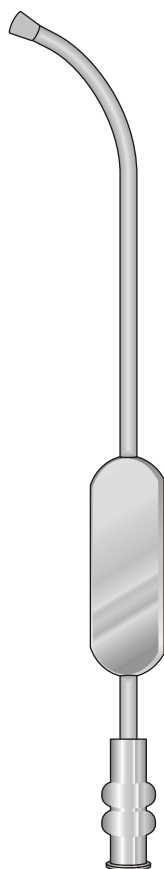

**KILLIAN**  
**GF-86** Ø 3 mm  
**GF-88** Ø 4 mm  
145 mm

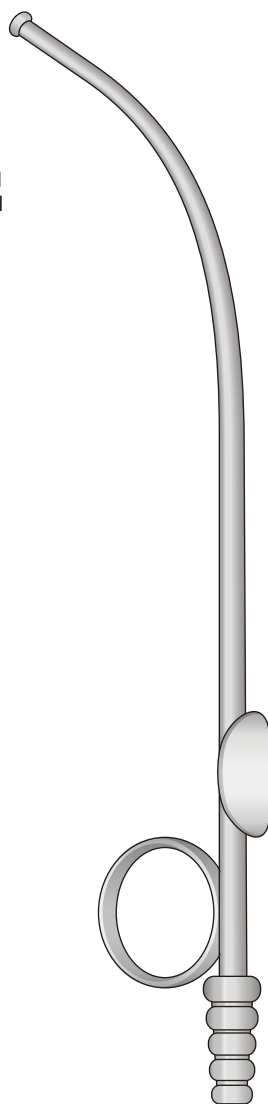

**GF-256** Ø 4,5 mm  
**GF-257** Ø 5,5 mm  
175 mm

Ø Innen  
Ø Inside  
Ø Interno  
Ø Interior  
Ø Intérieur

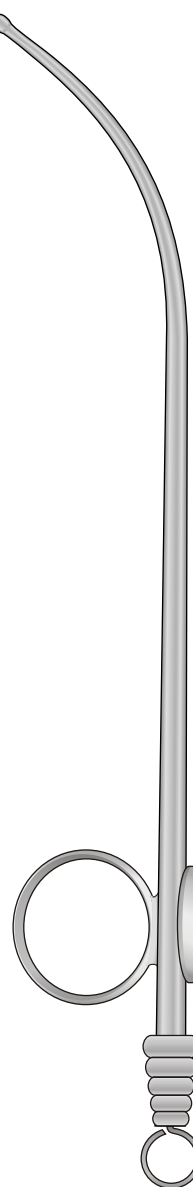

**MAGILL**  
**GF-100** Ø 1 mm  
200 mm

Ø Innen  
Ø Inside  
Ø Interno  
Ø Interior  
Ø Intérieur

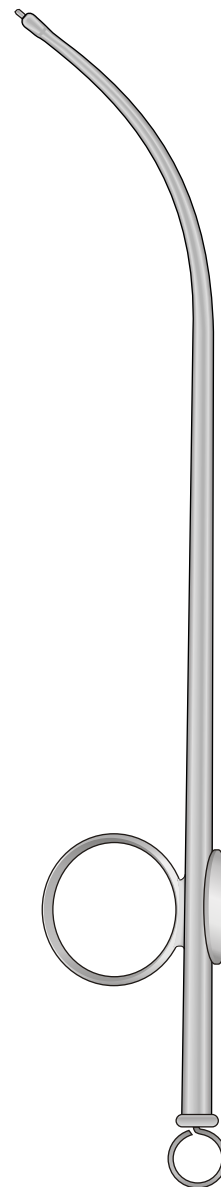

**MAGILL**  
**GF-101** Ø 1 mm  
**GF-102** Ø 2 mm  
**GF-103** Ø 3 mm  
200 mm

Mikro  
Saugkanülen

Micro  
Suctions Tubes

Micro cannule  
per aspirazione

MicroCánulas  
aspiradoras

Micro Canules  
aspiratrices

Infiltration Kanüle  
Infiltration Cannula  
Aghi-Cannula da infiltrazione  
Aguja de infiltración  
Aiguille pour infiltration

6 Loch  
6 Openings  
6 Fori  
6 Bucos  
6 Troux  
Ø 1,5 mm

6 Loch - 6 Openings  
6 Fori - 6 Bucos  
6 Troux  
Ø 1,5 mm

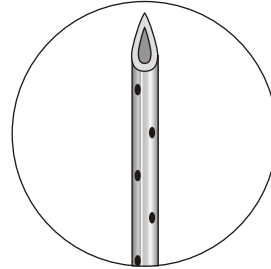

6 Loch  
6 Openings  
6 Fori  
6 Bucos  
6 Troux  
Ø 1,3 mm

Ø 2,5 mm

Ø 2 mm

Ø 3 mm

Ø 2 mm

Ø 3 mm

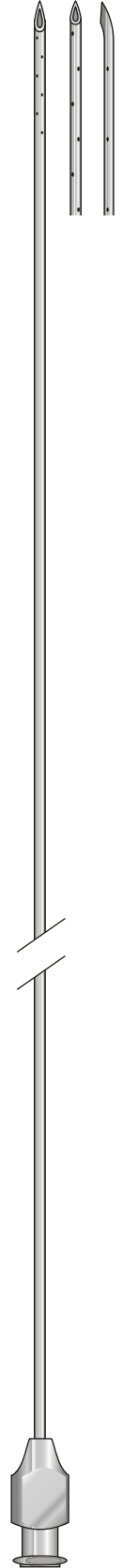
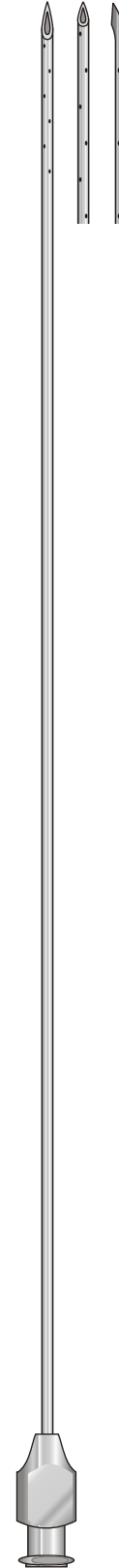
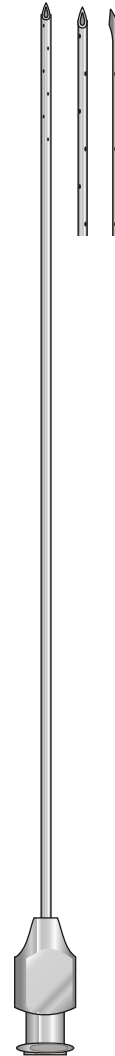
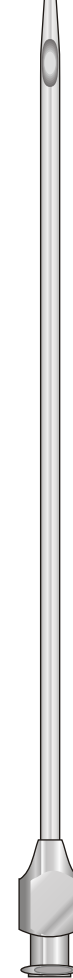
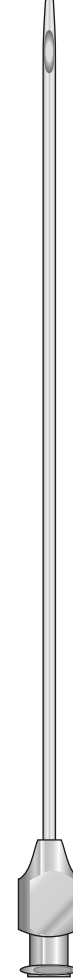
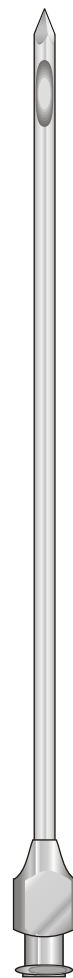
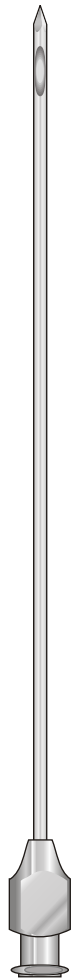

**ES-05**  
70 mm

**ES-06**  
110 mm

**ES-07**  
110 mm







**ES-08**  
110 mm

**ES-09**  
110 mm

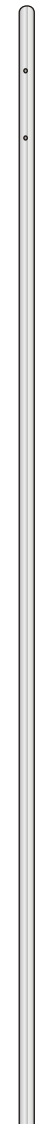
**ES-34**  
120 mm

**ES-35**  
200 mm

**ES-36**  
270 mm

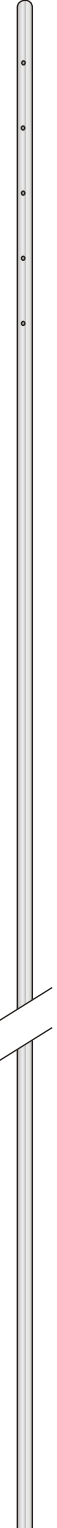
Mikro Saugkanülen	Micro Suctions Tubes			Micro cannule per aspirazione	MicroCánulas aspiradoras			Micro Canules aspiratrices	
	Infiltration Kanüle Infiltration Cannula Aghi-Cannula da infiltrazione Aguja de infiltración Aiguille pour infiltration			10 Loch 10 Openings 10 Fori 10 Bucos 10 Troues Ø 1.5 mm	3 Loch 3 Openings 3 Fori 3 Bucos 3 Troues Ø 2.0 mm	5 Loch 5 Openings 5 Fori 5 Bucos 5 Troues Ø 3.0 mm	2 Loch 2 Openings 2 Fori 2 Bucos 2 Troues Ø 3.0 mm	5 Loch - 5 Openings 5 Fori - 5 Bucos 5 Troues Ø 2.0 mm	5 Loch - 5 Openings 5 Fori - 5 Bucos 5 Troues Ø 2.0 mm
	7 Loch 7 Openings 7 Fori 7 Bucos 7 Troues Ø 1,5 mm	2 Loch 2 Openings 2 Fori 2 Bucos 2 Troues Ø 2,0 mm	5 Loch 5 Openings 5 Fori 5 Bucos 5 Troues Ø 2,0 mm						
5 Loch 5 Openings 5 Fori 5 Bucos 5 Troues Ø 1,5 mm									
<b>ES-41</b> 100 mm	<b>ES-51</b> 150 mm	<b>ES-52</b> 150 mm	<b>ES-53</b> 150 mm	<b>ES-54</b> 200 mm	<b>ES-55</b> 200 mm	<b>ES-56</b> 200 mm	<b>ES-59</b> 200 mm	<b>ES-57</b> 300 mm	<b>ES-58</b> 300 mm

Makro  
Saugkanülen

Macro  
Suctions Tubes

Macro cannule  
per aspirazione

MacroCánulas  
aspiradoras

Macro Canules  
aspiratrices

1 Loch - 1 Opening  
1 Foro - 1 Bucos  
1 Trou

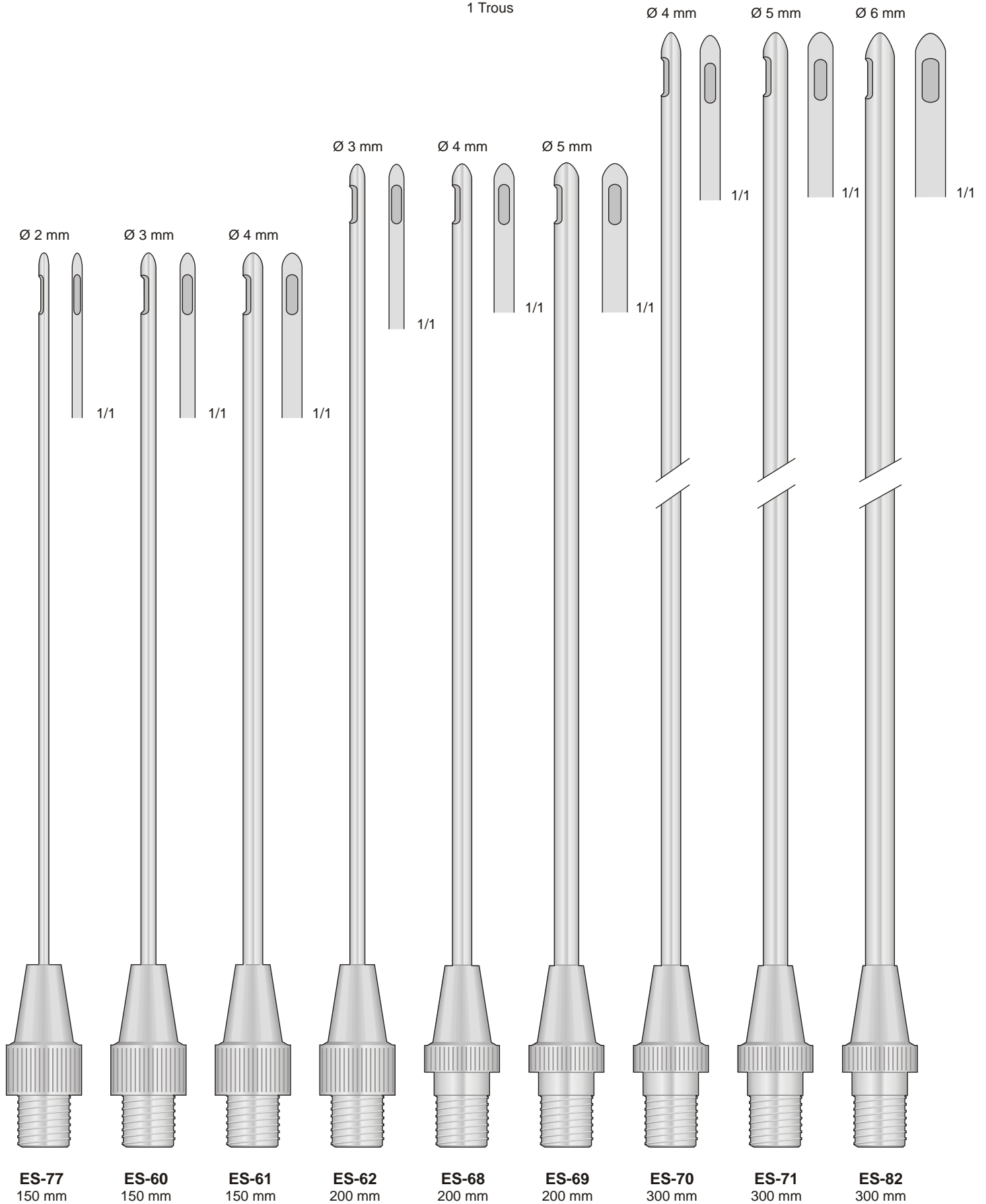

Makro  
Saugkanülen

Macro  
Suctions Tubes

Macro cannule  
per aspirazione

MacroCánulas  
aspiradoras

Macro Canules  
aspiratrices

3 Loch - 3 Openings  
3 Fori - 3 Bucos  
3 Troues

Ø 3 mm

Ø 4 mm

Ø 5 mm

Ø 6 mm

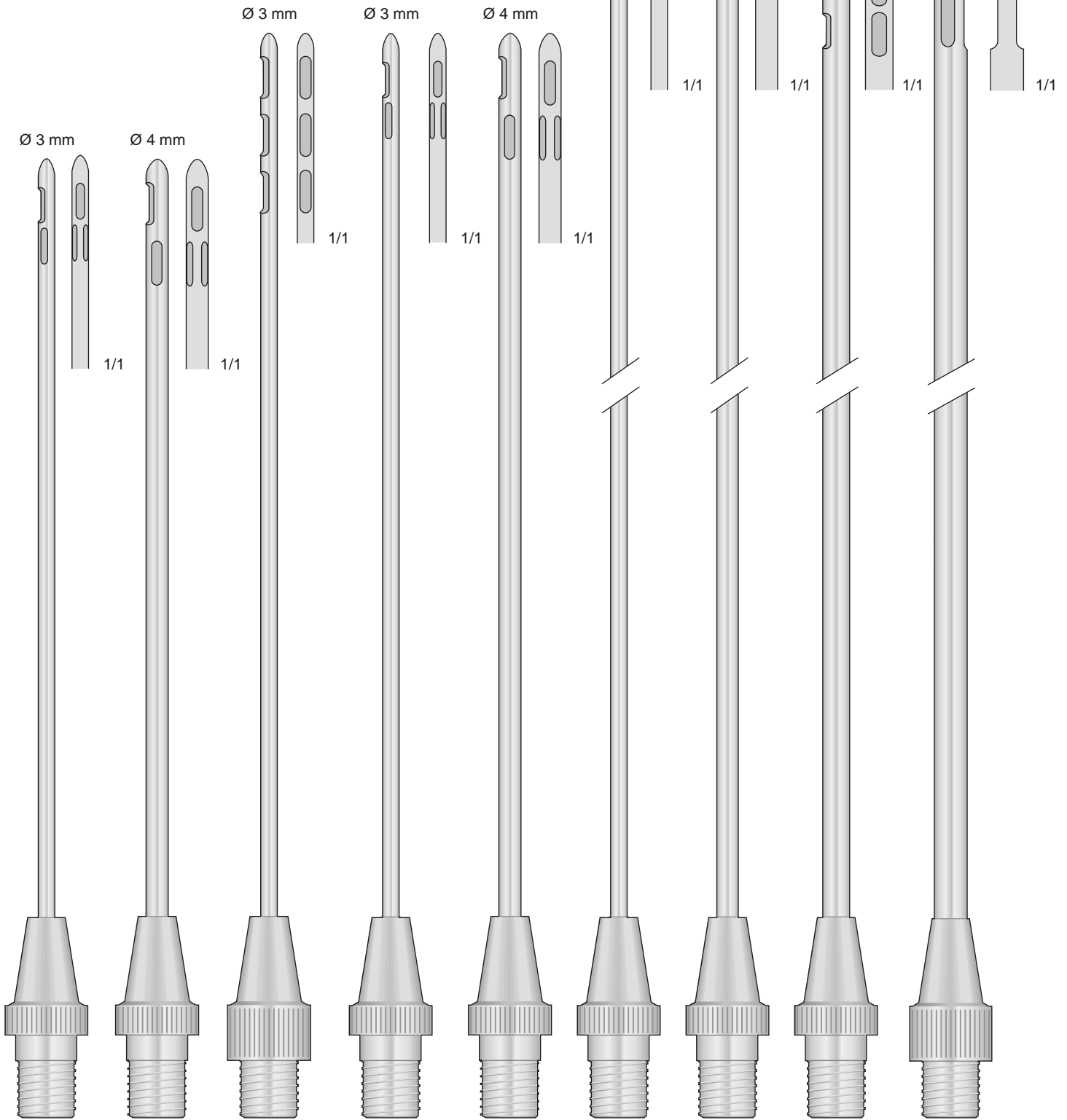

**ES-83**  
150 mm

**ES-84**  
150 mm

**ES-79**  
200 mm

**ES-85**  
200 mm

**ES-63**  
200 mm

**ES-66**  
300 mm

**ES-67**  
300 mm

**ES-76**  
300 mm

**ES-81**  
300 mm

Makro  
Saugkanülen

Macro  
Suctions Tubes

Macro cannule  
per aspirazione

MacroCánulas  
aspiradoras

Macro Canules  
aspiratrices

2 Loch - 2 Openings  
2 Fori - 2 Bucos  
2 Troues

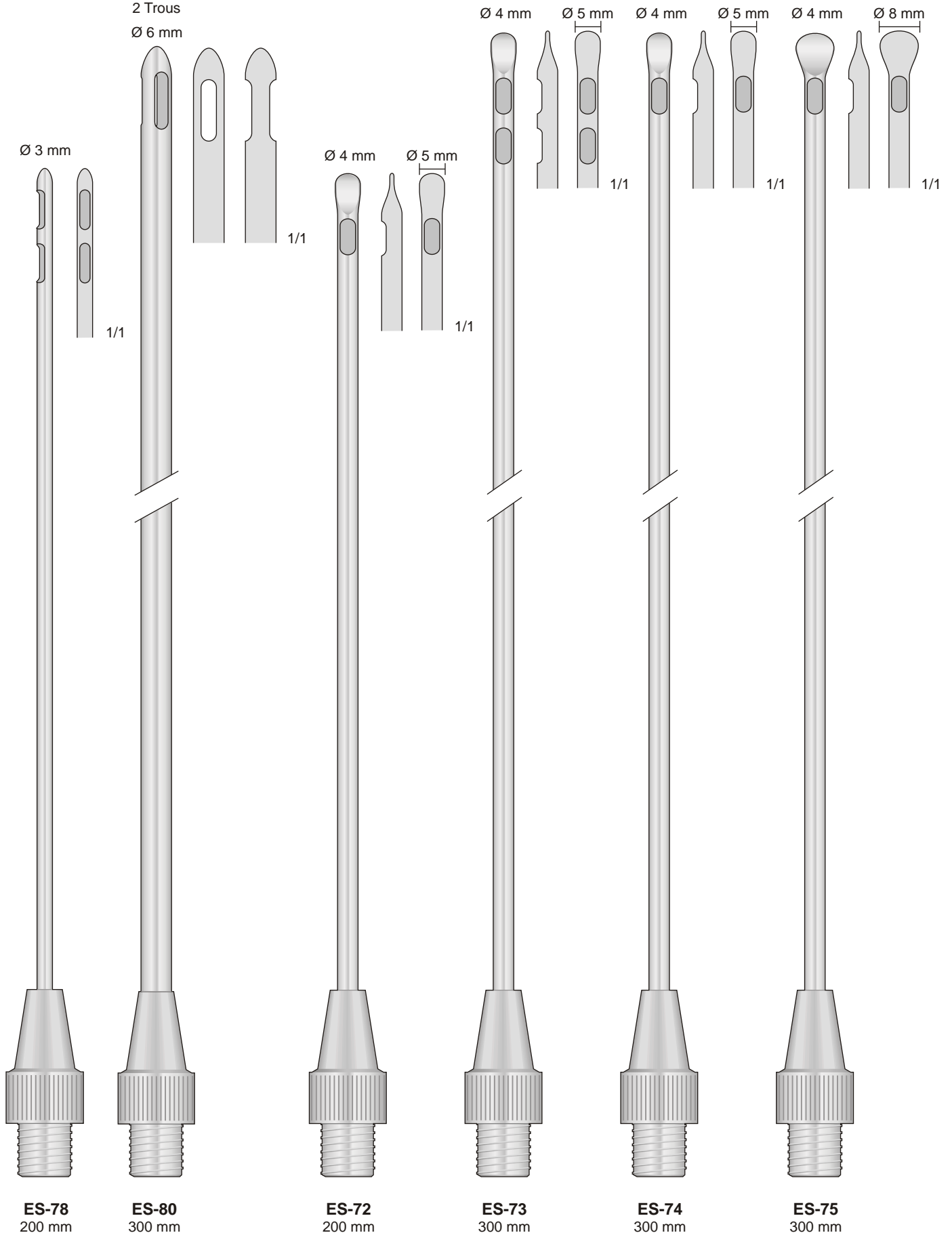



Makro  
Saugkanülen

Biegsam  
Malleable  
Malleabile  
Maleable  
Souple  
Ø 3 mm

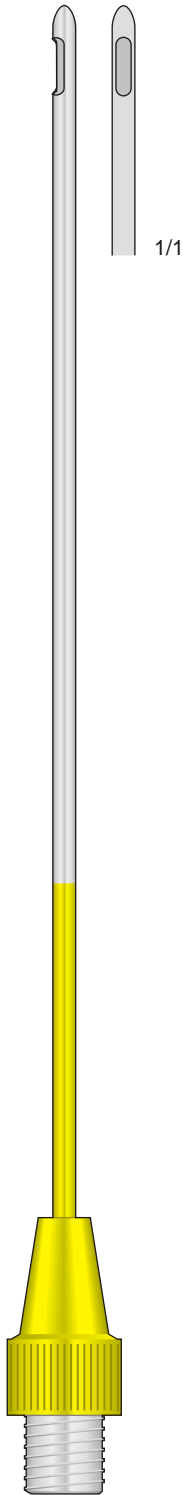

**ES-92**  
200 mm

Macro  
Suctions Tubes

Biegsam - Malleable  
Malleabile - Maleable - Souple

Ø 4 mm    Ø 5 mm

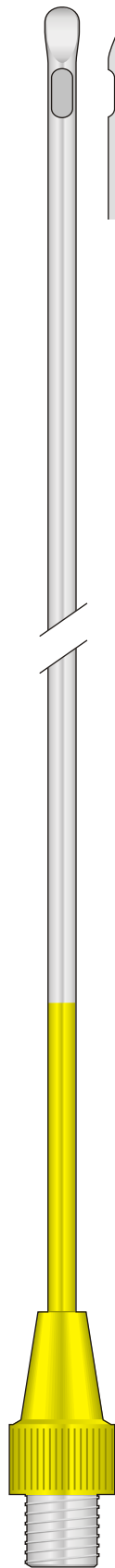
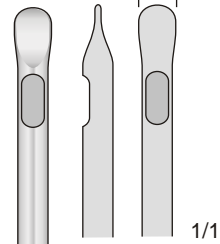

**ES-102**  
300 mm

Macro cannule  
per aspirazione

Alu-Griff  
Aluminium Handle  
Manico in Alluminio  
Mango de aluminio  
Manche à aluminium

Ø 18 mm

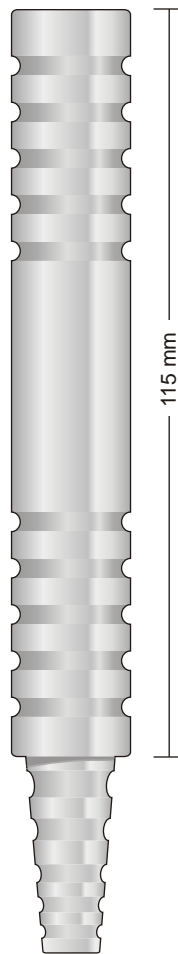

**ES-39**  
145 mm

MacroCánulas  
aspiradoras

Griff Rostfrei  
Stainless Steel Handle  
Manico in acciaio Inox  
Mango de acero  
inoxidable  
Manche en  
acier inoxydable

Ø 15 mm

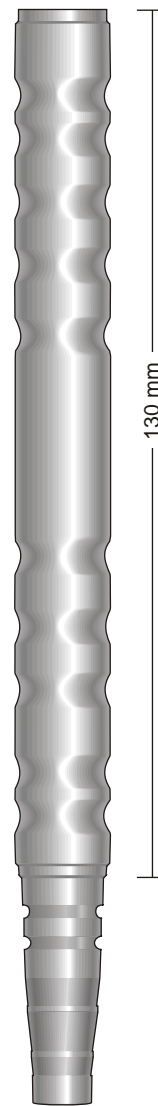

**ES-49**  
165 mm

Macro Canules  
aspiratrices

Alu-Griff Blau  
Blue Aluminium Handle  
Manico in Alluminio blu  
Mango à aluminium azul  
Manche de aluminium bleu

Ø 18 mm

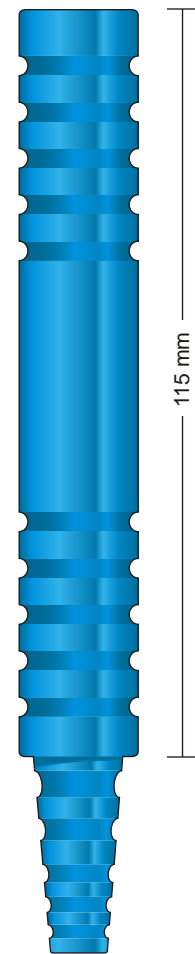

**ES-50**  
145 mm

The **LUER-LOCK**  
to **LUER-LOCK**  
Transfer System

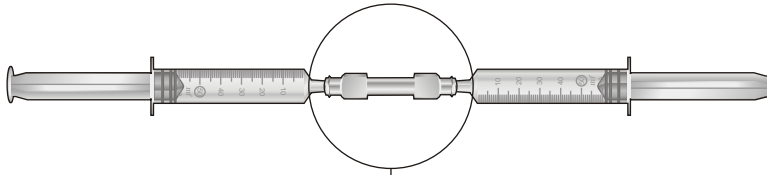

Spritzenstop, zur Gewinnung  
eines Vakuums in der Spritze  
Stop for syringes,  
lock maintains vacuum in the syringe  
Stop per siringhe  
Stop pour siringe

Rostfreies Verbindungsteil  
zum Spritze  
Connection Piece for Suction  
Raccordo Inox per siringa  
Adapter en acier pour siringe

Ø est. 9 mm

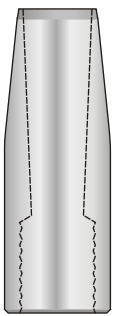

Ø int. 10 mm

**ES-01**  
40 mm

Raccordo per  
due siringhe

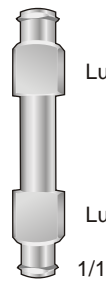

Luer Lock

Luer Lock

1/1

**ES-03**  
37 mm



**ES-111**  
115 mm

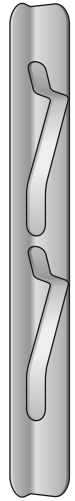

**ES-112**  
115 mm



**OL-01**  
120 mm

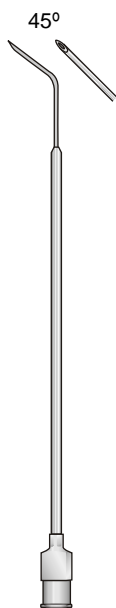

**OL-02**  
110 mm

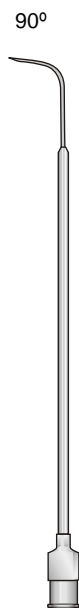

**OL-03**  
110 mm



**OL-04**  
110 mm

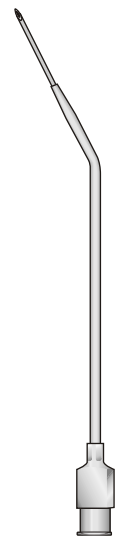

**OL-05**  
110 mm

Nadel für Biopsie  
Kanülenreinigungs-  
bürsten

Biopsy needles  
Cleaning brush for  
tubes

Aghi da biopsia  
Scovolini per pulizia  
cannule

Agujas para Biopsia  
Cepillo para limpiar  
cánulas

Aiguilles pour Biopsie  
Brosse de nettoyage  
pour canules

Sterilisier bar  
Autoclavable  
Autoclavabile  
Esterilizabile  
Stérilisable

Handwaschbürste  
Nail brushes  
Spazzola per unghie  
Cepillos de uñas  
Brosse à ongles

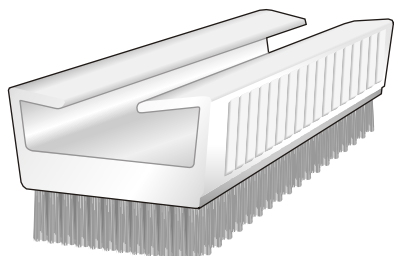

**GF-200**  
4 x 11 cm

Punktionskanülen mit Luer-Lock Ansatz  
Puncture needles with Luer-Lock connector  
Cannule per puntura con innesto Luer-Lock  
Cánulas para punción con cono Luer-Lock  
Canules à ponctions avec embout Luer-Lock

Ø 2 mm

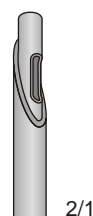

2/1

Reinigungsbürsten  
Cleaning brushes  
Spazzole per pulire  
Cepillos de limpieza  
Brosses à lavement

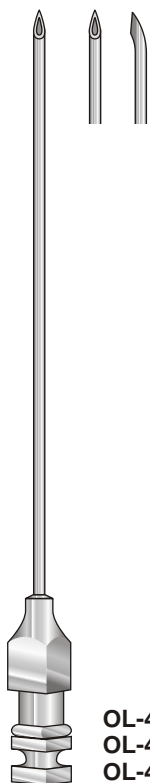
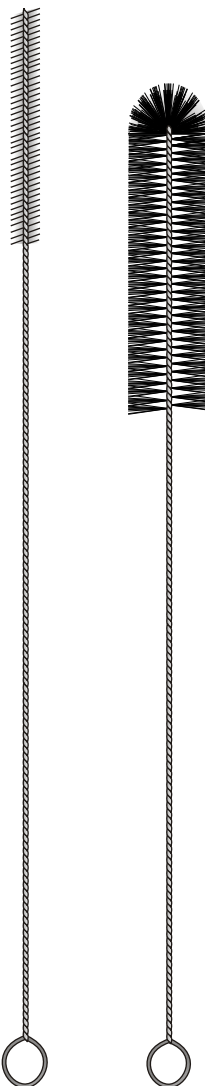

TUOHY  
**OL-41/OL-43**

**OL-41** - 1,30 x 80 mm  
**OL-42** - 1,50 x 80 mm  
**OL-43** - 1,65 x 80 mm



QUINKE  
**OL-44/OL-49**

**OL-44** - 0,70 x 80 mm  
**OL-45** - 0,70 x 90 mm  
**OL-46** - 1,00 x 80 mm  
**OL-47** - 1,00 x 90 mm  
**OL-48** - 1,20 x 90 mm  
**OL-49** - 1,20 x 100 mm

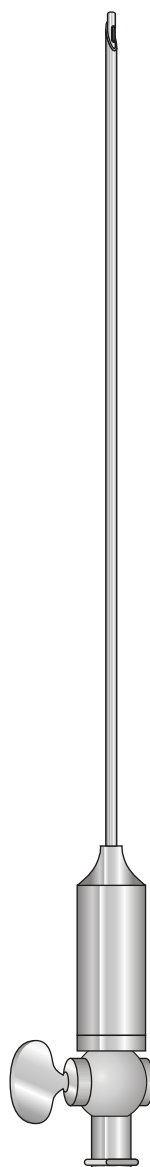

VERESS  
**GF-89/GF-90**

LUER LOCK  
**GF-89** 120 mm  
**GF-90** 150 mm

**GF-40**  
235 mm

**GF-188**  
220 mm

Nagelzangen

Nail Nippers

Tronchesi per unghie

Pinzas para cortar uñas

Pinces pour couper ongles

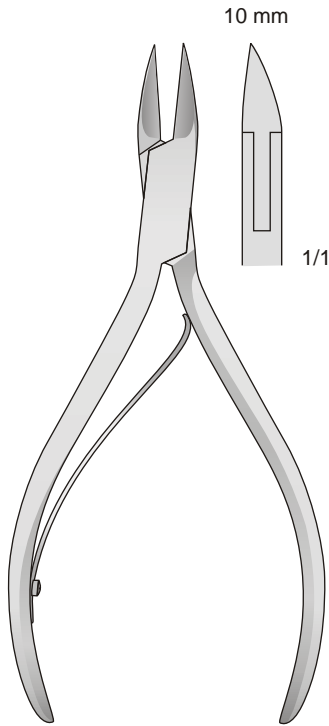

**GS-42**  
100 mm

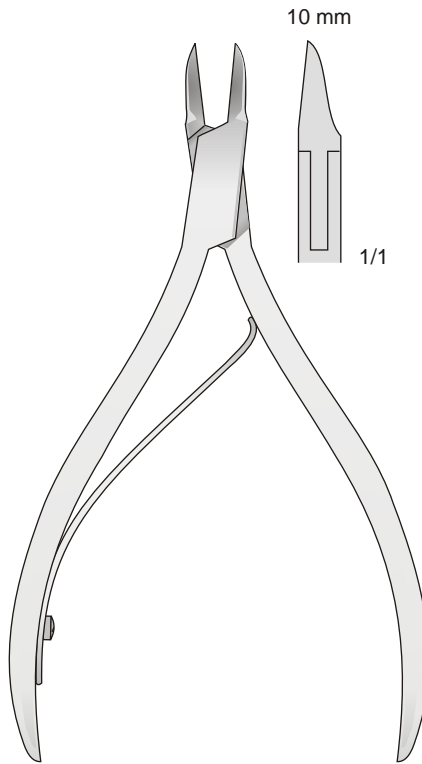

**GS-43**  
110 mm

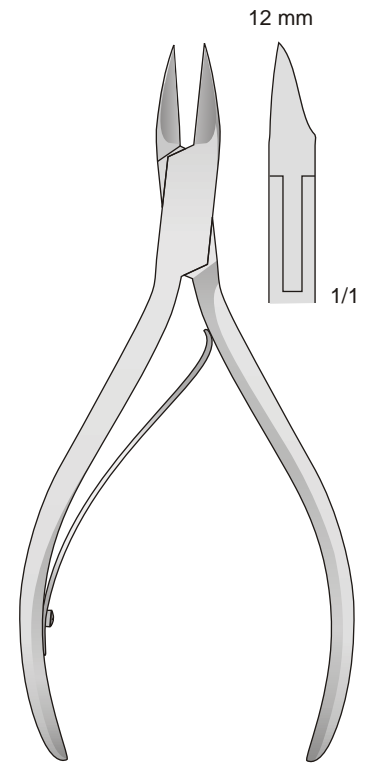

**GS-44**  
110 mm

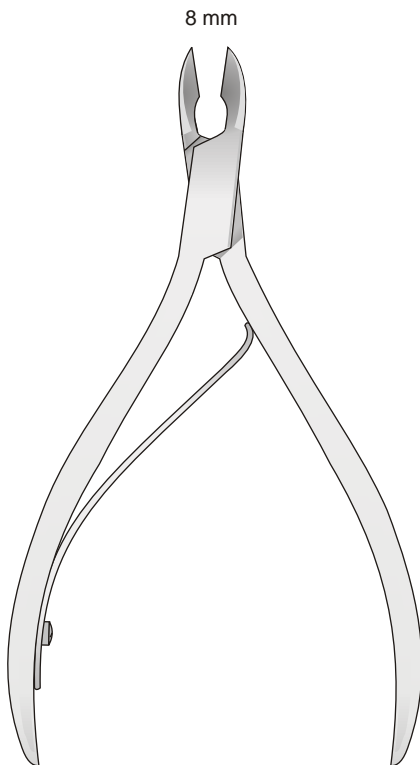

**GS-41**  
110 mm

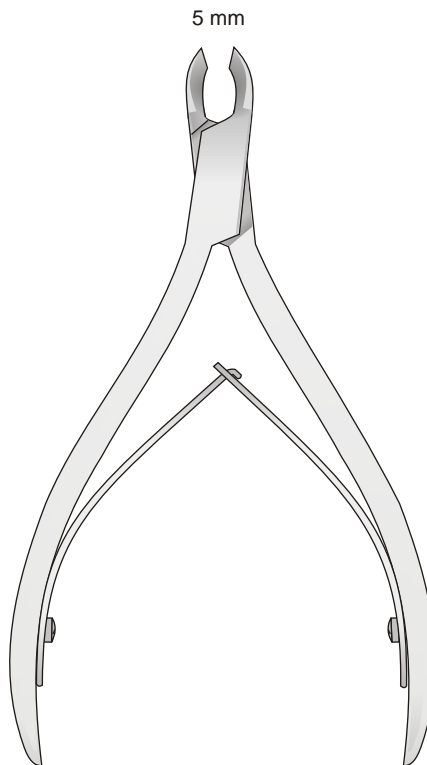

**GS-45**  
110 mm

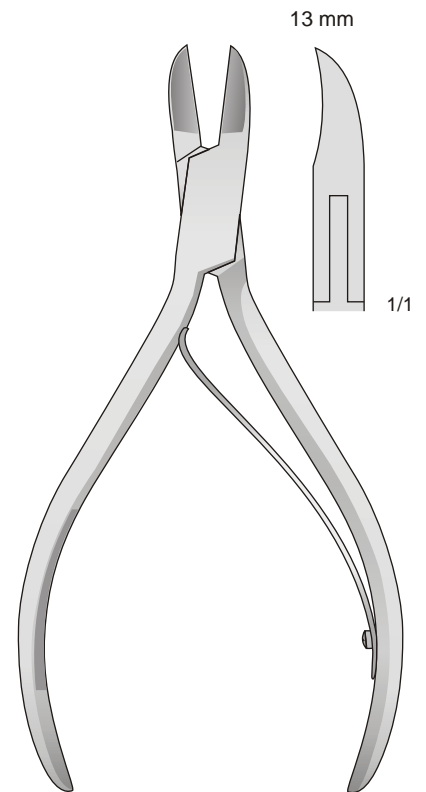

**GS-21**  
120 mm

Nagelzangen

Nail Nippers

Tronchesi per unghie

Pinzas para cortar uñas

Pinces pour couper ongles

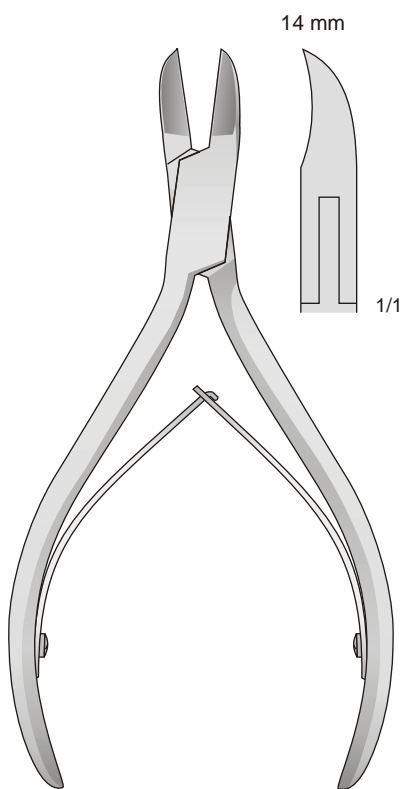

**GS-32**  
120 mm

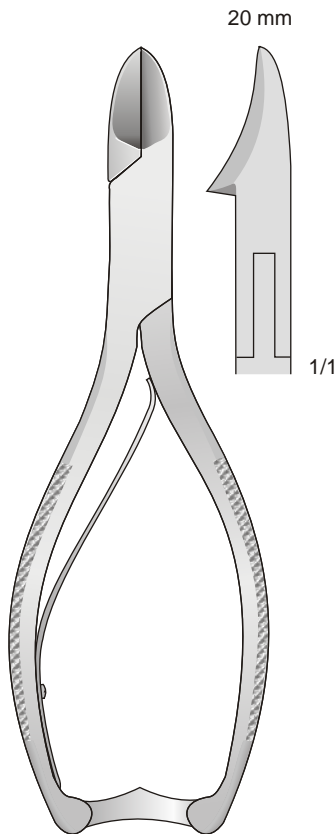

**GS-20**  
135 mm

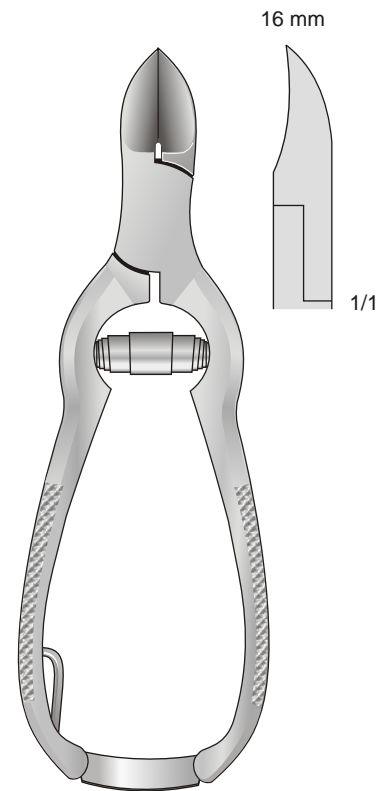

**GS-46**  
120 mm

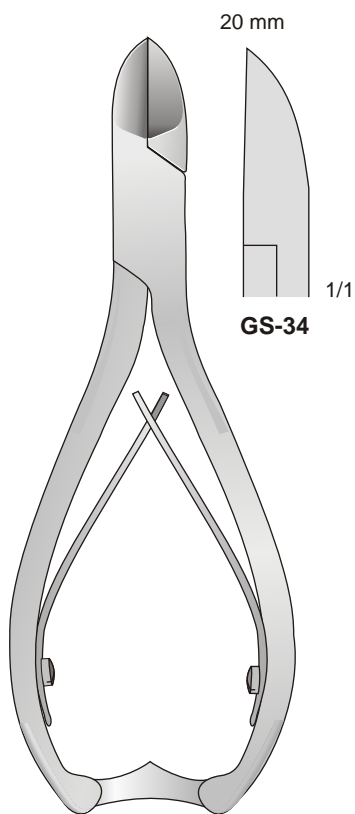

**GS-34/GS-35**  
140 mm

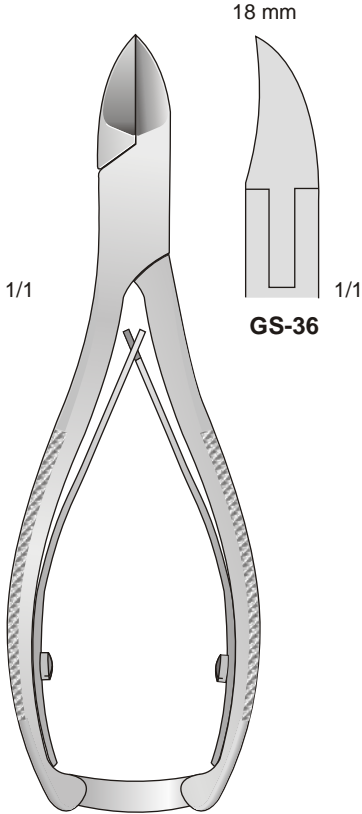
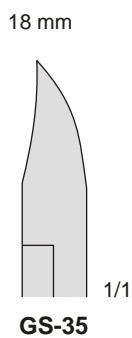

**GS-36/GS-48**  
140 mm

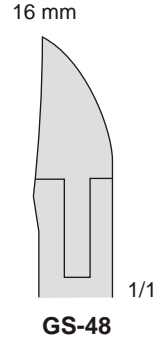
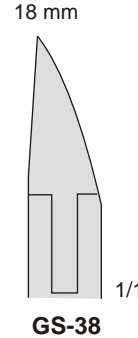
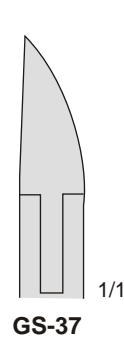
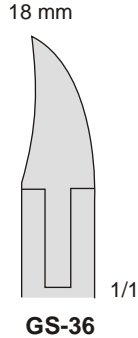

Eckenzangen  
Fusspflege Instrumente

Nail corner forceps  
Chiropody instruments

Tronchesi per unghie  
Strumenti per pedicure

Corta uñas  
Instrumentos para pedicure

Pinces à ongles  
Instruments pour pedicure

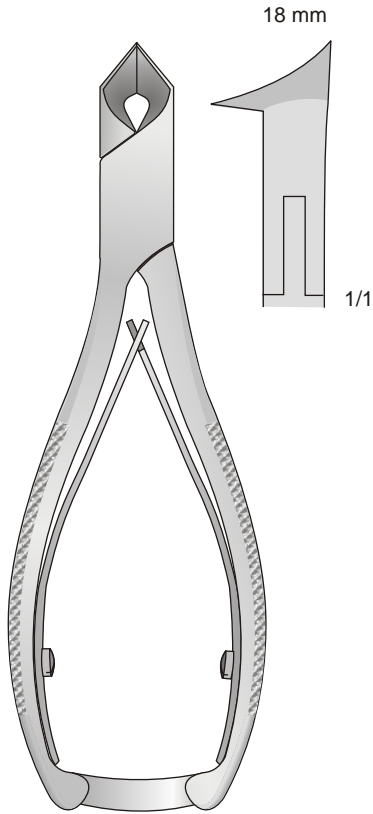

**GS-50**  
135 mm

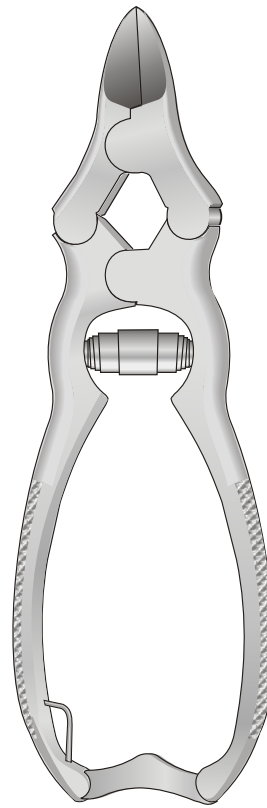

**GS-19/GS-22**  
155 mm

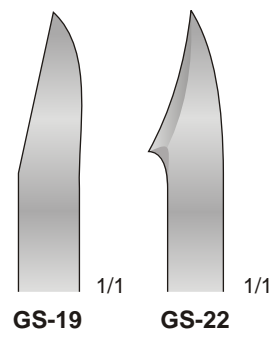

**GS-19**

**GS-22**

Instrumente für eingewachsene Nägel  
Forceps for ingrown nails  
Strumento per unghie incarnite  
Instrumento para cortar uñas  
Pince pour fendre les ongles incarnés

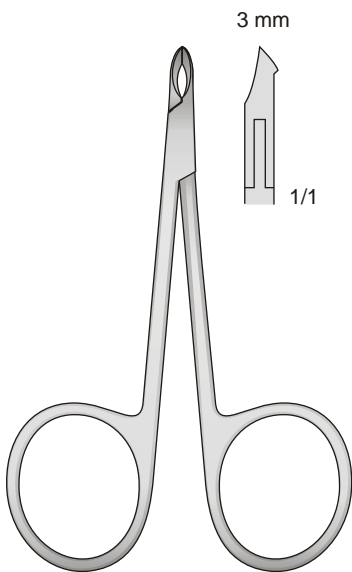

**GS-40**  
85 mm

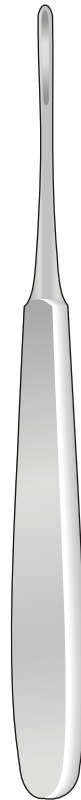

**WARWICK-JAMES**  
**DL-20**  
155 mm

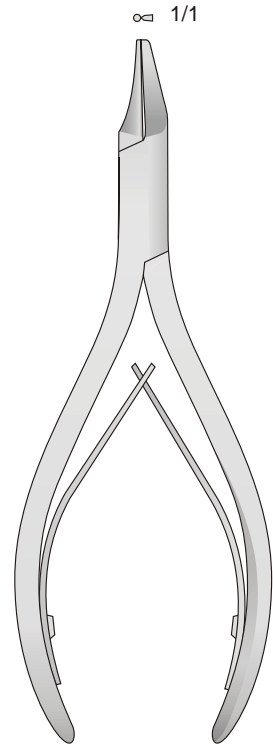

**DP-09**  
135 mm



**SADIQ SURGICAL CO.**

Catalogue 2015 / 2016



## Plastic Surgery

12

Instrumentenwartung und Sterilisierung  
Instrument Maintenance and Sterilization  
Manutenzione degli strumenti e Sterilizzazione  
Mantenimiento de instrumentos y Esterilización  
Entretien des instruments et Stérilisation





Wasserlösliche Schmiermittel von chirurgische Instrumenten  
 Lubricant Oil for surgical instruments  
 Olio lubrificante per strumenti chirurgici  
 Lubrificante para instrumentos  
 Entretien pour instruments

**RODHOIL**

Schmiermittel mit hoher Dichte. Es sichert den perfekten Gebrauch und die Leichtgängigkeit aller chirurgischen Instrumente. Man gibt es auf die Verbindungen und Gelenke und in alle beweglichen Teile, die Reibungen unterworfen sind.

**RODHOIL**

Lubricant to high density. It assures the perfect utility and fluency of all the surgical instruments. For apply in to loosens, join and in all the parts in subject movement subject to attrition.

**RODHOIL**

Lubrificante ad alta densità. Assicura la perfetta funzionalità e scorrevolezza di tutti gli strumenti chirurgici. Da applicare negli snodi, giunture e in tutte le parti in movimento soggette ad attrito.



**DB-OLR**  
50 cc

Das wasserlösliche Schmiermittel verlängert die Lebensdauer von chirurgische Instrumenten  
 Soluble lubricant extends useful life of surgical instruments  
 Lubrificante anticorrosivo e detergente per strumenti chirurgici  
 Lubrificante soluble en agua, so uso prolonga la duracion de los instrumentos quirurgicos  
 Lubrifiant soluble dans l'eau prolonge la vie des instruments chirurgicaux

**CLEANLACT**

Reinigungskonzentrat für chirurgische Instrumente. Es wirkt antibakteriell, nicht-ätzend und schmierig. Es garantiert die perfekte Erhaltung aller Instrumente aus Stahl, entfernt eventuelle Flecken, Ränder, und Bräunungen von Sterilisationen, Desinfektionen und Reinigungen mit hartem Wasser. Es sollte regelmäßig verwendet werden.

**CLEANLACT**

Product concentrated for surgical instruments. It explains an action anti-corrosive, antibacterium and lubricant. It guarantees the perfect maintenance of all the instruments in steel eliminating eventual stains and burnishes to sterilization, disinfection and to washings with hard waters. It used periodically.

**CLEANLACT**

Prodotto concentrato per strumenti chirurgici. Esplica un azione anticorrosiva batteriostatica e lubrificante. Garantisce il perfetto mantenimento di tutti gli strumenti in acciaio eliminando eventuali macchie, aloni e brunture dovute a sterilizzazioni, disinfezioni e a lavaggi con acque dure. Va usato periodicamente.



**DB-50M**  
500 cc

**DB-1L**  
1000 cc

Schleifsteine  
und

Sharpening Stones  
and Accessories

Pietre per affilare  
ed accessori

Piedras de afilar  
y accesorios

Pierres à aiguiser  
et accessoires

Schleifsteine - Sharpening stones  
Pietre di Arkansas per affilatura strumenti  
Materiales para afilar - Pierres d'affutage

Schleifstein-Öl  
Oil for grinding stones  
Olio per affilatura strumenti  
Huile d'affutage



**DB-299**  
ARKANSAS  
conica n° 299



**DB-OL**  
30 cc



**DB-96**  
ARKANSAS  
n° 8



**DB-6A**  
ARKANSAS  
n° 6A



**DB-4**  
ARKANSAS  
n° 4

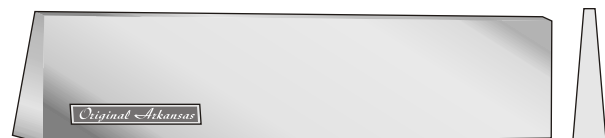

**DB-22A**  
ARKANSAS

Gefäße aus Edelstahl

Stainless Steel  
Receptacles

Recipienti in acciaio  
inossidabile

Recipientes de acero  
inoxidable

Réceptients en acier  
inoxydable

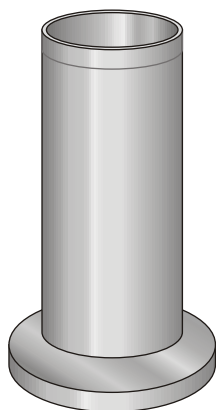

**CS-51** Ø 50 mm h 100 mm  
**CS-52** Ø 50 mm h 150 mm  
**CS-55** Ø 80 mm h 180 mm

Runder Sterilbehälter mit Ausguss  
Lotion bowls capsules  
Capsule inox con fondo piano e becco  
Cubetas de acero inoxidable  
Cuvettes de acier inoxydable

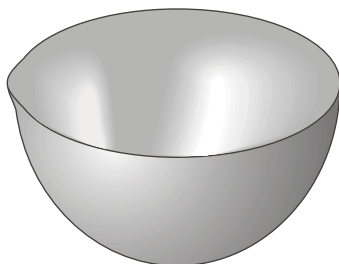

**CS-01** Ø 140 mm 15 cc  
**CS-02** Ø 160 mm 75 cc  
**CS-03** Ø 80 mm 225 cc  
**CS-04** Ø 100 mm 325 cc  
**CS-05** Ø 120 mm 500 cc  
**CS-06** Ø 150 mm 600 cc

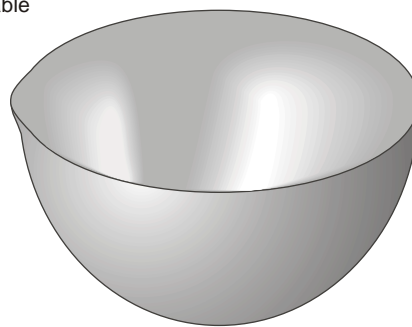

**CS-80** Ø 180 mm 1000 cc  
**CS-81** Ø 200 mm 1450 cc  
**CS-82** Ø 220 mm 2000 cc  
**CS-83** Ø 240 mm 3300 cc

Nierenschalen  
Kidney bowls  
Bacinelle reniformi  
Riñoneras  
Bassins réniformes

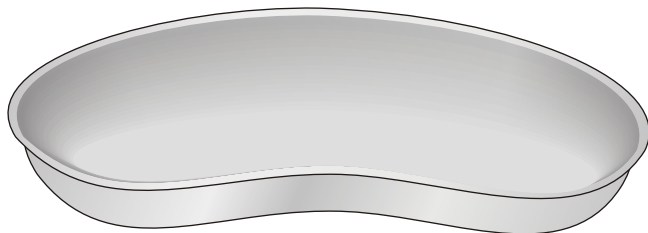

**BR-20** 200 mm  
**BR-25** 250 mm  
**BR-28** 280 mm

Schalen  
Trays  
Vassoi porta-strumenti  
Bandejas  
Bassins

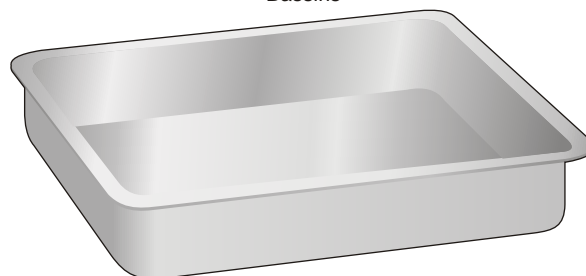

**VS-20** 210 x 110 x 25 mm  
**VS-26** 250 x 180 x 30 mm  
**VS-30** 300 x 220 x 30 mm

Gefäße aus Edelstahl

Stainless Steel  
Cassettes

Recipienti in acciaio  
inossidabile

Recipientes de acero  
inoxidable

Réceptients en acier  
inoxydable

Nadelkassetten  
Needle Cases  
Scatole per aghi  
Estuches para agujas  
Boîtes pour aiguilles

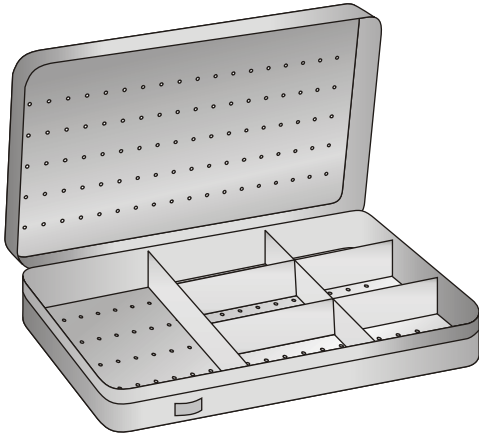

**BS-27**  
150 x 90 x 20 mm

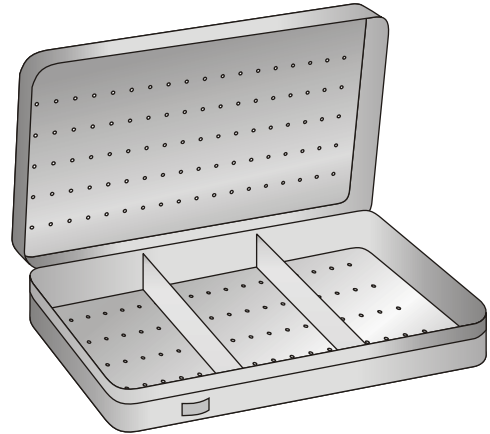

**BS-23**  
150 x 90 x 20 mm

Deckel und Boden perforiert  
Perforated lid and bottom  
Coperchio e base perforati  
Tapa y fondo perforado  
Couvercle et fond perforé

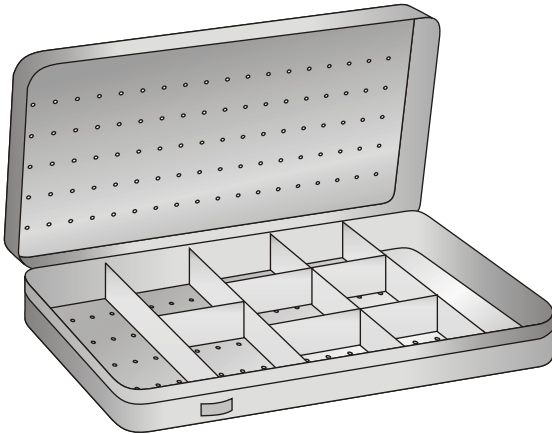

**BS-28**  
220 x 120 x 20 mm

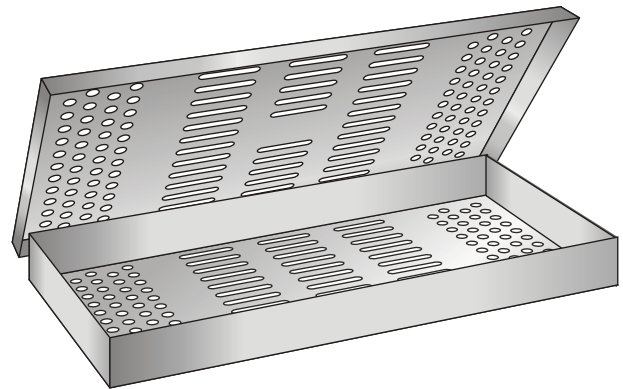

**BS-41**  
275 x 130 x 25 mm

Mit 2 Sterilisiergestelle  
With 2 Sterilizing Racks  
Con 2 Supporti per sterilizzazione  
Con 2 Bastidores para esterilización  
Avec 2 Cadres de stérilisation

Mit Sterilisiergestelle und Trenneinteilung  
With Sterilizing Rack and Compartments  
Con Supporto per sterilizzazione e scomparti  
Con Cuadro de esterilización y compartimentos  
Avec Cadre de stérilisation et compartimentée

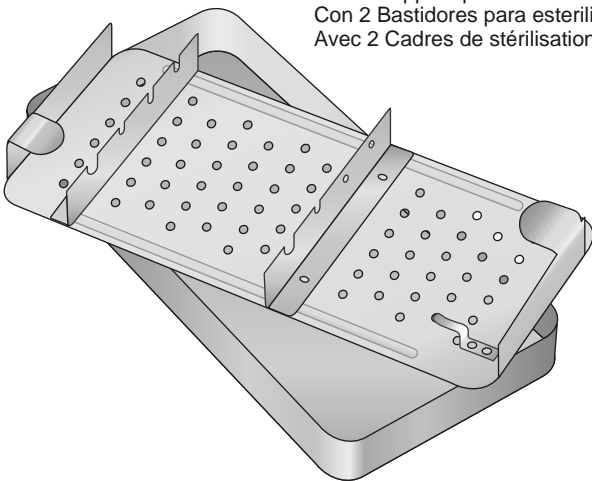

**BS-30** 180 x 90 x 35 mm

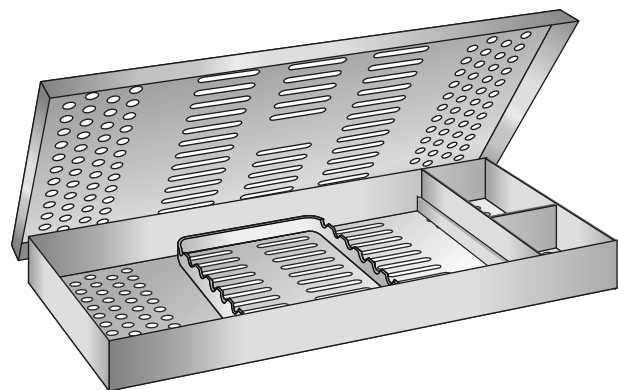

**BS-40** 275 x 130 x 25 mm  
**BS-42** 285 x 190 x 25 mm

Gefäße aus Edelstahl

Stainless Steel  
Cassettes

Recipienti in acciaio  
inossidabile

Recipientes de acero  
inoxidable

Réceptients en acier  
inoxydable

Tray Inox mit Silikoneinrichtung - Stainless Steel Cassettes with Silicone Racks  
Tray Inox con griglia in silicone - Recipientes de acero con equipo de silicona  
Cassettes en acier avec aménagement en silicone

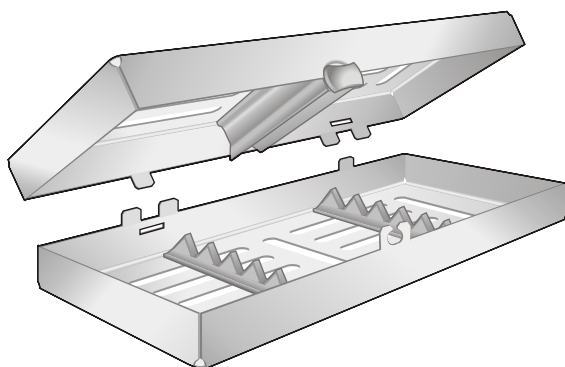

**BS-59** | Für 5 Instrumente  
185 x 75 x 35 mm | For 5 Instruments  
Per 5 strumenti  
Para 5 instrumentos  
Pour 5 instruments

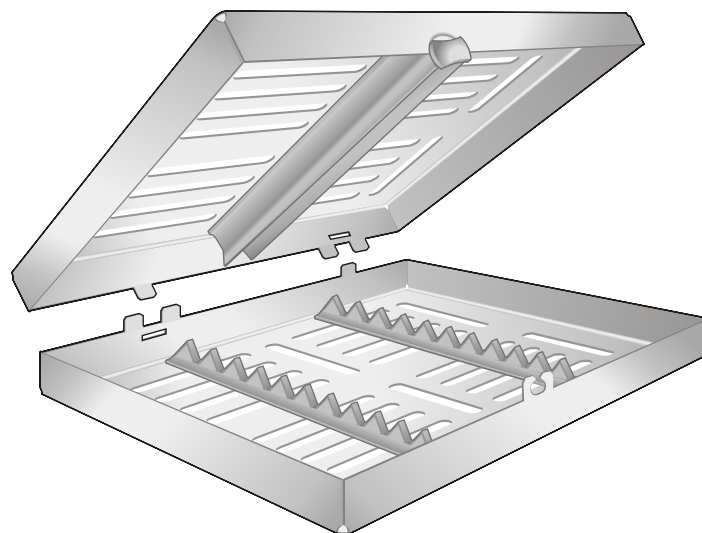

**BS-60** | Für 10 Instrumente  
185 x 135 x 35 mm | For 10 Instruments  
Per 10 strumenti  
Para 10 instrumentos  
Pour 10 instruments

**BS-61** | Für 20 Instrumente  
290 x 185 x 35 mm | For 20 Instruments  
Per 20 strumenti  
Para 20 instrumentos  
Pour 20 instruments

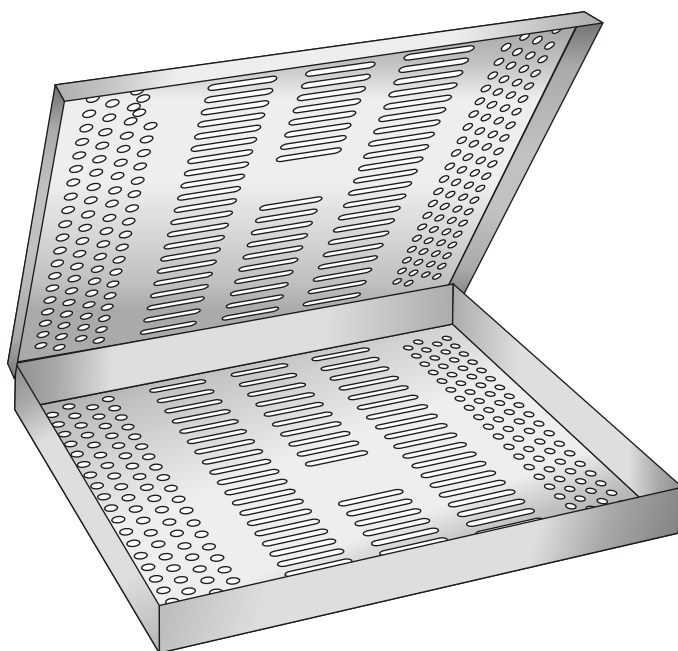

**BS-43**  
285 x 190 x 25 mm

Instrumentenkästen  
Instrument Boxes  
Cestelli rettangolari  
Cajas para instrumentos  
Panier rectangulaire

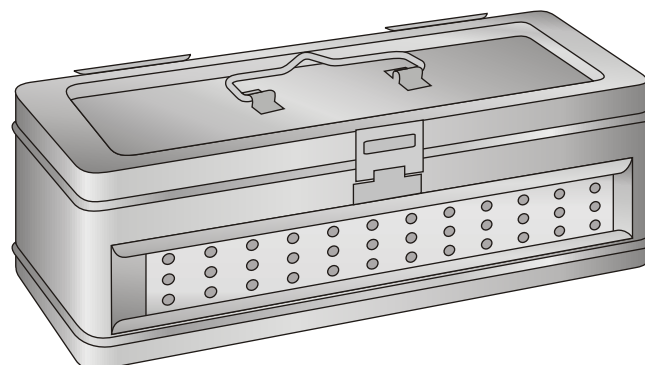

**CS-32** 300 x 150 x 60 mm  
**CS-33** 300 x 150 x 90 mm  
**CS-34** 300 x 150 x 180 mm

Sterilisierbar - Autoclavable  
 Autoclavabili - Esterilizable  
 Stérilisable

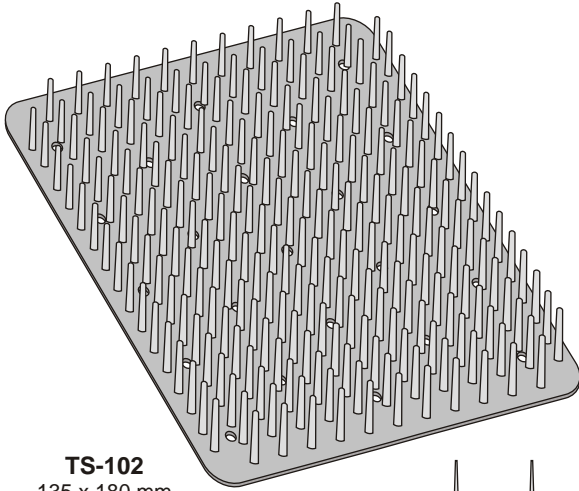

**TS-102**  
 135 x 180 mm

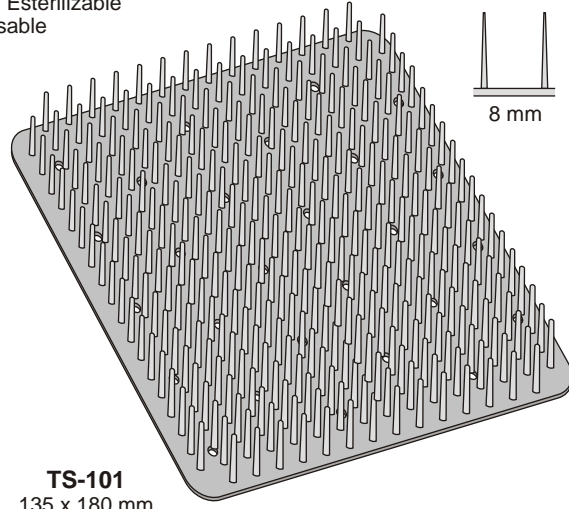
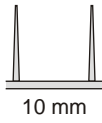

**TS-101**  
 135 x 180 mm

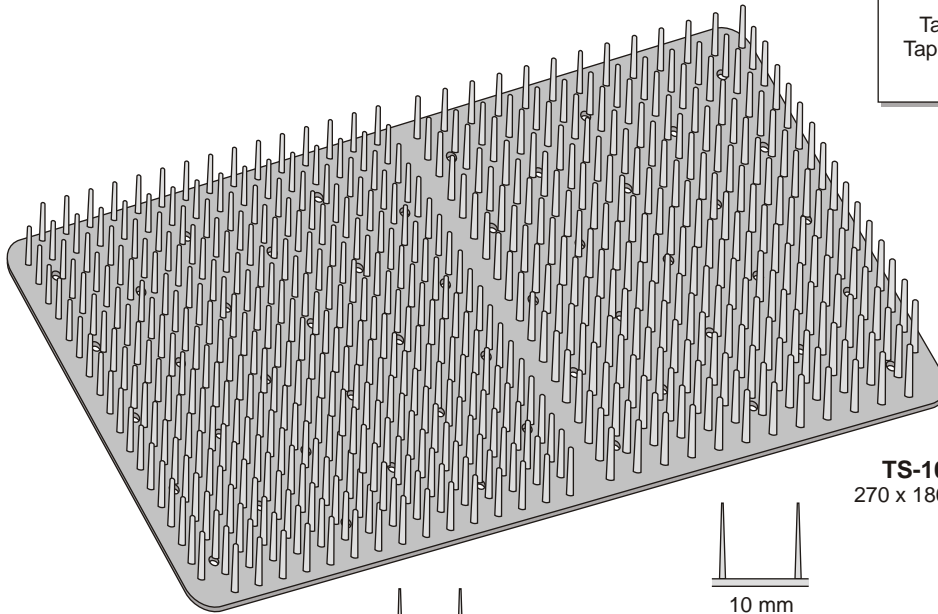
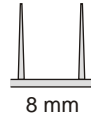

**TS-104**  
 270 x 180 mm

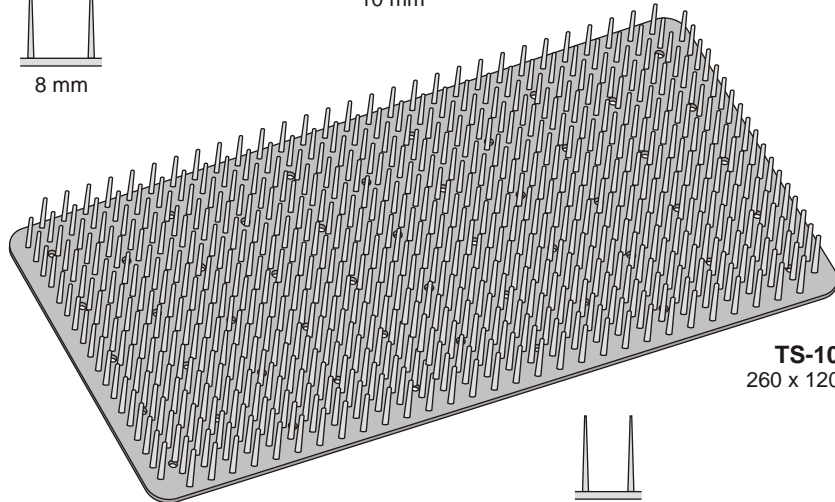
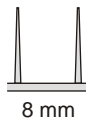
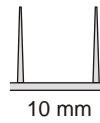

**TS-103**  
 260 x 120 mm



Silikon Matten  
 Matte en silicone  
 Tappeti in aghi di silicone  
 Tapete en agujas de silicona  
 Tapis en Silicone

Sterilisierzangen

Sterilizing forceps

Pinze per sterilizzazione

Pinzas para esterilización

Pinces à stérilisation

Sterilisierzangen zum Fassen und Halten Steriler Instrumente  
 Sterilizing forceps for picking up and holding of sterile instruments  
 Pinze per prelevare strumenti sterilizzati  
 Pinzas para esterilización  
 Pinces pour saisir les objets stérilisés



**GS-02**  
145 mm

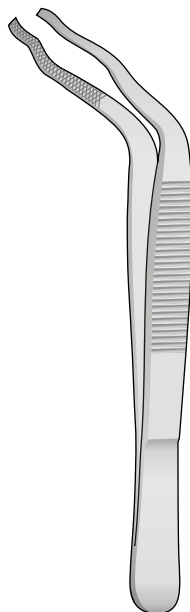

**DAVIS GS-03**  
160 mm

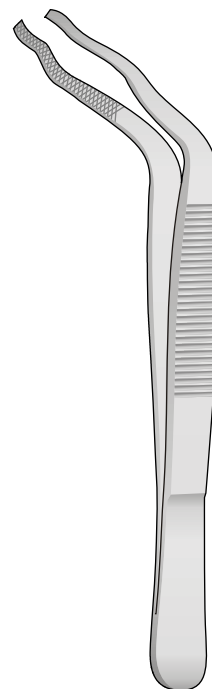

**DAVIS GS-04**  
200 mm

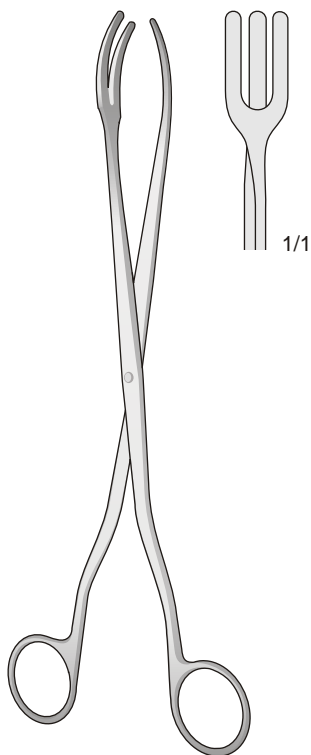

**GS-10**  
200 mm

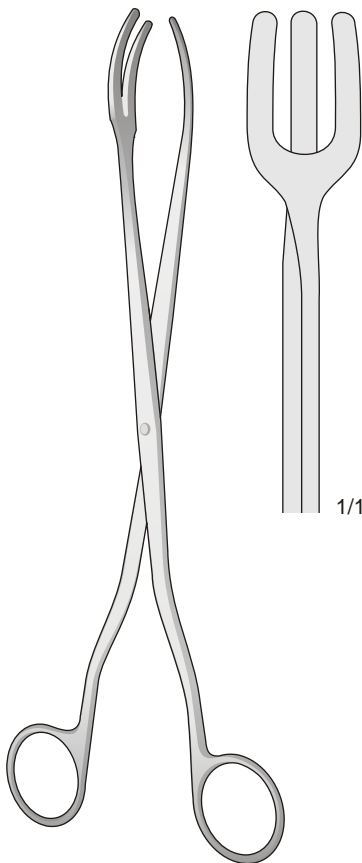

**GS-11**  
300 mm

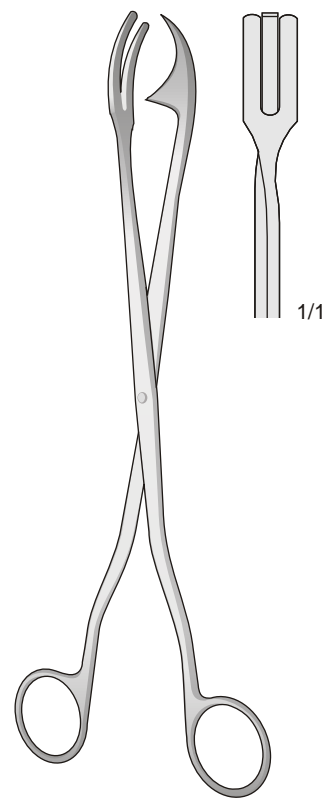

**ROGGE GS-06**  
230 mm

Sterilisierzangen

Sterilizing forceps

Pinze per sterilizzazione

Pinzas para esterilización

Pinces à stérilisation

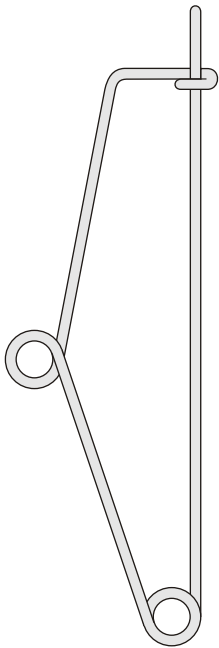

**MAYO**  
**GS-01**  
140 mm

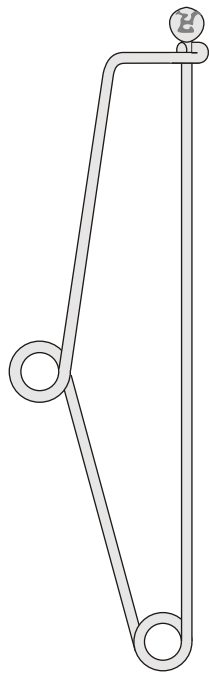

**MAYO**  
**GS-07**  
140 mm

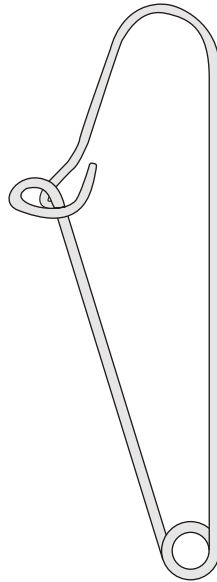

**BUNT**  
**GS-09**  
110 mm

Sterilisierzangen zum Fassen und Halten Steriler Instrumente  
Sterilizing forceps for picking up and holding of sterile instruments  
Pinze per prelevare strumenti sterilizzati  
Pinzas para esterilización  
Pinces pour instruments stérilisés

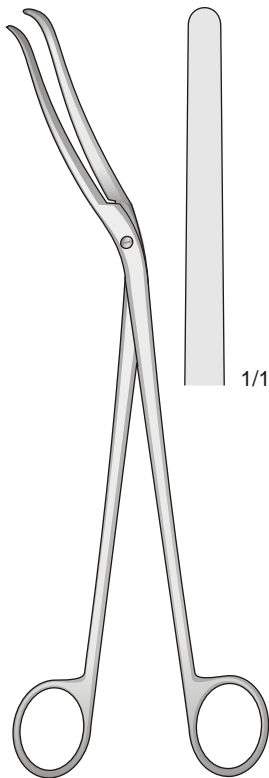

**CHEATTLE**  
**GS-05**  
265 mm

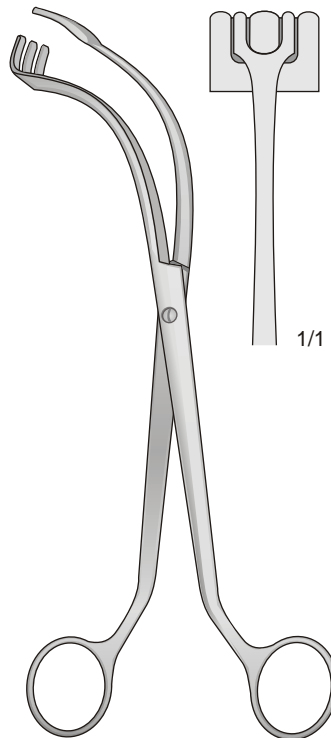

**COLLIN**  
**GS-30**  
250 mm

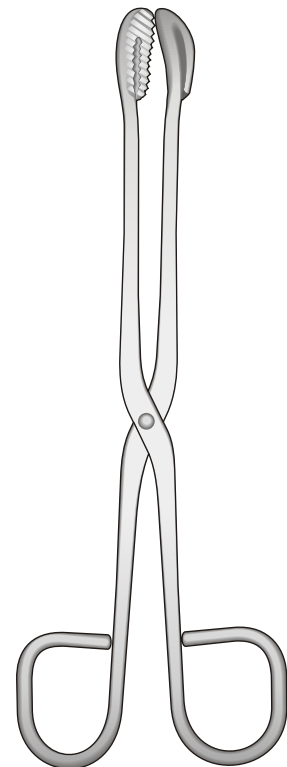

**GS-13** 200 mm  
**GS-14** 300 mm





**SADIQ SURGICAL CO.**

Catalogue 2015 / 2016



## Plastic Surgery

13

Alphabetisches Inhaltsverzeichnis  
Alphabetical index  
Indice alfabético  
Indice alfabético  
Index alphabétique



**A**

<b>ADSON</b> , Absaugkanülen	293
- Wundhaken	193
- Raspatorien	218
- Chirurgische Pinzetten	87, 88, 101, 104
<b>ADSON-BROWN</b> , Chirurgische Pinzetten	87, 88
<b>ALDERDYCE</b> , Raspatorien	209
<b>ALLIS</b> , Gewebe Faszange	110
<b>ALM</b> , Wundspreizer	191
<b>Mundsperrer</b>	165 - 168
<b>ARKANSAS</b> , Schleifesteine	310
<b>ARRUGA</b> , Nadelhalter	154
<b>ASCH</b> , Rhinologie	282
<b>AUFRIECHT</b> , Wundspreizer	170, 197
- Knochenfeilen	257
<b>AUFRIECHT-WALTER</b> , Wundspreizer	170
<b>AUSTIN</b> , Chirurgische Pinzetten	86
<b>AXENFELD</b> , Wundspreizer	176
<b>AYERS</b> , Mikro Pinzetten	99

**B**

<b>BABBUSH</b> , Elevators	209
<b>BABY-ADSON</b> , Arterienklemmen und Ligaturklemmen	127
<b>BABY-ALLIS</b> , Gewebe Faszange	110
<b>BABY-CRILE</b> , Arterienklemmen	120
<b>BABY-CRILE-WOOD</b> , Nadelhalter	147
<b>BABY-METZENBAUM</b> , Feine Scheren	34
<b>BABY-MIXTER</b> , Arterienklemmen und Ligaturklemmen	127
<b>BACKHAUS</b> , Tuchklemmen	112
<b>BALLENGER</b> , Osteotome	225
- Skalpelle	12
- Rhinologie	238
<b>BALLENGER-HAYEK</b> , Raspatorien	211
<b>BARON</b> , Absaugkanülen	291
<b>BARRAQUER</b> , Wundhaken	174
- Mikro Nadelhalter	134, 136
- Cilienpinzetten	106
<b>BARTH</b> , Sharfe Löffel	261
<b>BEASLEY-BACOCK</b> , Chirurgische Pinzetten	87
<b>BEAUPRE</b> , Cilienpinzetten	106
<b>BECKMANN</b> , Nasen Spekula	200
<b>BEER</b> , Cilienpinzetten	106
<b>BELLUCCI</b> , Absaugkanülen	291
- Mikro Ohrzängchen	158
<b>BENGOLEA</b> , Arterienklemmen	126
<b>BERGMANN</b> , Chirurgische Hämmer	249
<b>BEYER</b> , Hohlmeißelzange	273
<b>BIEMER</b> , Approximatoren	157
- Gefäß Clips	155
<b>BIEMER-MÜLLER</b> , Approximatoren	157
<b>BIRCHER-GANSKE</b> , Hohlmeißelzange	276
<b>BIRKETT</b> , Arterienklemmen	126
<b>BIRO</b> , Feine Scheren	22
<b>BISHOP-HARMON</b> , Mikro Pinzetten	100
<b>Skalpelle</b>	6 - 12
<b>BLUMENTHAL</b> , Hohlmeißelzange	270
<b>BÖHLER</b> , Hohlmeißelzange	275
<b>BOIES</b> , Rhinologie	283
<b>BONN</b> , Mikro Pinzetten	100
<b>BONNEY</b> , Chirurgische Pinzetten	102
<b>BOYNTON</b> , Nadelhalter	154
<b>BOWMANN</b> , Sonden	160
<b>BRAUN</b> , Arterienklemmen	114
<b>BROCK</b> , Mikro Scheren	17
- Mikro Pinzetten	81
- Mikro Nadelhalter	133
<b>BRÜNINGS</b> , Skalpelle	12
<b>BRUNS</b> , Sharfe Löffel	264
<b>BUCKLEY</b> , Osteotome	224
<b>BUNT</b> , Sterilisierzange	316

**C**

<b>Absaugkanülen</b>	287 - 302
----------------------	-----------

<b>CAPLAN</b> , Knochensplitterscheren	47
- Rhinologie	283
<b>CARTER</b> , Raspatorien	212
<b>CASPAR</b> , Scalpellgriffe	9
<b>CASTROVIEJO</b> , Mikro Nadelhalter	136, 137
- Nadelhalter	138, 140
- Meßinstrumente	4
<b>CHADWICK</b> , Feine Scheren	22
<b>CHEATTLE</b> , Sterilisierzange	316
<b>CINELLI</b> , Feine Scheren	34
- Rhinologie	233
<b>COLLIN</b> , Sterilisierzange	316
<b>CONVERSE</b> , Skalpelle	11
- Wundspreizer	172
- Knochenfeilen	254
- Nadelhalter	145
<b>CONWAY</b> , Wundspreizer	179
<b>CORN</b> , Chirurgische Pinzetten	86
<b>CORONAL</b> , Wundspreizer	190
<b>COTTLE</b> , Skalpelle	11
- Wundspreizer	172, 175, 177, 179
- Chirurgische Scheren	23, 46, 64
- Knochenfeilen	257
- Chirurgische Hämmer	249
- Mikro Pinzetten	99
- Osteotome	230, 236, 237
- Raspatorien	210, 211, 212
- Rhinologie	201
- Knorpelquetsche	175
<b>COTTLE-KNAPP</b> , Feine Scissors	24
<b>COTTLE-MASING</b> , Feine Scissors	22
<b>COTTLE-NEIVERT</b> , Wundspreizer	175
<b>COTTLE-WALSHAM</b> , Rhinologie	282
<b>CRAIG</b> , Rhinologie	283
<b>CRILE</b> , Arterienklemmen	119, 120
<b>CRILE-MURRAY</b> , Nadelhalter	141
<b>CRILE-WOOD</b> , Nadelhalter	141, 147, 153
<b>Sharfe Löffel</b>	261 - 265
<b>CUSHING</b> , Wundspreizer	178, 181, 182
- Periostotome	218
- Chirurgische Pinzetten	93, 102
<b>CUSHING-KOCHER</b> , Wundspreizer	182

**D**

<b>DANDY</b> , Arterienklemmen	119
<b>DAVIS</b> , Wundhaken	206
- Sterilisierzange	315
<b>DAVIS-BOYLE</b> , Mundsperrer	166
<b>DEAN</b> , Chirurgische Scheren	45
<b>DEAVER</b> , Chirurgische Scheren	32
- Wundhaken	184
<b>DERF</b> , Nadelhalter	141, 145
<b>DESMARRES</b> , Wundhaken	179
- Wundhaken Isoliert	130
- Mikro Pinzetten	99
<b>DE BAKEY</b> , Atraumatische Pinzetten	96, 97, 98
- Chirurgische Pinzetten	103
- Nadelhalter	150
<b>DE MARTEL</b> , Feine Arterienklemmen	111
<b>DIEFFENBACH</b> , Gefäßclips	155
<b>DIETRICH</b> , Nadelhalter	138
<b>DINGMANN</b> , Mundsperrer	167
- Hohlmeißelzange	276
- Knochenfeilen	256
<b>Dissektoren</b>	205 - 208
<b>Wundhaken</b>	172 - 197
<b>DIXON-LOVELACE</b> , Arterienklemmen	126
<b>DUNN-DAUTREY</b> , Wundhaken	171
<b>DUPLAY</b> , Nasen Spekula	3

**E**

<b>ELSCHNIG</b> , Chirurgische Pinzetten	100
<b>EPKER</b> , Osteotome	235

## F

<b>FACE-LIFT</b> , Chirurgische Scheren	67, 69
- Wellenschliff Scheren	70
<b>FAGER</b> , Dissektoren - Separatores	206
<b>FARABEUF</b> , Wundhaken	180
- Periostotome	219
<b>FARABEUF-COLLIN</b> , Raspatorien	219
<b>FAULKNER</b> , Rhinologie	232
<b>FAURE</b> , Tuchklemmen	112
<b>FEICHENFELD</b> , Splitterpinzetten	106
<b>FERGUSSON</b> , Absaugkanülen	290
<b>FERRIS-SMITH-CUSHING</b> , Knochensplitterscheren	274
<b>FINSEN</b> , Wundhaken	191
<b>FOERSTER-BALLENGER</b> , Tamponzangen	115
<b>FOMON</b> , Skalpelle	11
- Wundhaken	175
- Chirurgische Scheren	45, 46, 64
- Feine Scheren	34
- Knochenfeilen	255, 259
- Periostotome	213
- Rhinologie	233
<b>Scheren</b>	15 - 75
<b>FOSTER-GILLIES</b> , Nadelhalter	144
<b>FOX</b> , Scharfe Löffel	263
<b>FRAZIER</b> , Absaugkanülen	290, 293
<b>FREEMAN</b> , Wundhaken	190
- Chirurgische Scheren	66, 71
- Wellenschliff Scheren	72
<b>FREEMAN-GORNEY</b> , Chirurgische Scheren	66, 71
<b>FREEMAN-KAYE</b> , Chirurgische Scheren	66, 67, 73
<b>FREER</b> , Osteotome	223
- Skalpelle	12
- Mikro Wundhaken	175
- Periostotome	209, 212, 213, 216
<b>FRIEDMANN</b> , Hohlmeißelzangen	270, 271

## G

<b>GALLAHER</b> , Knochenfeilen	256
<b>GEMINI</b> , Arterienklemmen	129
<b>GERALD</b> , Chirurgische Pinzetten	95, 104
<b>GERALD-BROWN</b> , Chirurgische Pinzetten	95
<b>GIDEF</b> , Feine Arterienklemmen	118
<b>GIESSEN</b> , Wundhaken	180
<b>GILLIES</b> , Mikro Wundhaken	173
- Atraumatische Pinzetten	98
- Nadelhalter	144, 148
<b>GIUNTA-NASAL</b> , Wellenschliff Scheren	70
<b>GLASSMAN</b> , Chirurgische Scheren	27
<b>GOLDMANN</b> , Rhinologie	283
<b>GOLDMAN-FOX</b> , Chirurgische Scheren	25, 49, 53
- Feine Scheren	25
<b>GOOD</b> , Tonsillenschere	43
<b>GORNEY</b> , Absaugkanülen	289
- Wundhaken	190
- Chirurgische Scheren	43, 73
- Hohlmeißelzange	47
- Wellenschliff Scheren	67, 68, 70, 72
<b>GRAEFE</b> , Feine Scheren	22
- Mikro Pinzetten	99
- Chirurgischen Pinzetten	86, 100
<b>GREEN</b> , Mikro Pinzetten	99
<b>GREENBERG-PAR</b> , Nasal Scheren	48, 54
<b>GREGORY</b> , Chirurgische Scheren	69
<b>GROSS</b> , Tamponzange	115
<b>GRUENWALD</b> , Chirurgische Pinzetten	105
<b>GULLIEN</b> , Absaugkanülen	289
<b>GUTHRIE</b> , Mikro Wundhaken	173, 174

## H

<b>HABERER</b> , Wundhaken	168
<b>HALSEY</b> , Nadelhalter	141, 145
<b>HALSTED</b> , Arterienklemmen	120
- Feine Arterienklemmen	118

<b>HALSTED-MOSQUITO</b> , Arterienklemmen	120
- Feine Arterienklemmen	117
<b>HARRINGTON</b> , Wundhaken	185
<b>HARTMANN</b> , Zungendrucker	169
- Absaugkanülen	294
- Rhinologie	198, 199
- Spekula für Erwachsene	3
<b>HARTMANN-BABY-MOSQUITO</b> , Feine Arterienklemmen	117
<b>HEANEY(HEGAR)</b> , Nadelhalter	142
<b>HEGAR</b> , Nadelhalter	142, 146
<b>HEGAR-MAYO-STILLE</b> , Nadelhalter	153
<b>HEISS</b> , Arterienklemmen	126
<b>HENAHAN</b> , Periostotome	218
<b>HEYMANN</b> , Chirurgische Scheren	46
<b>HEYMANN-KNIGHT</b> , Chirurgische Scheren	45
<b>HOUSE</b> , Absaugkanülen	292
- Wundhaken	178
<b>HOWARD</b> , Knochenfeilen	253
<b>HOWARTH</b> , Periostotome	211
<b>HUNT</b> , Mikro Pinzetten	99
<b>HUNTER</b> , Splitterpinzetten	106

## I

<b>IRIS</b> , Chirurgische Scheren	50, 53
- Feine Scheren	20
- Links Scheren	52
- Wellenschliff Scheren	65

## J

<b>JACOBSON</b> , Sharfe Löffel	261
- Mikro Scheren	16
- Mikro Nadelhalter	135
- Nadelhalter	139
<b>JACOBSON-MICRO</b> , Feine Arterienklemmen	111
<b>JAEGER</b> , Mikro Wundhaken	174
<b>JAMESON</b> , Chirurgische Scheren	23
<b>JAMESON-WERBER</b> , Chirurgische Scheren	23
<b>JANSEN</b> , Sharfe Löffel	261
- Hohlmeißelzange	272
- Chirurgische Pinzetten	105
- Raspatorien	219
<b>JONES</b> , Tuchklemmen	112, 114
<b>JOSEPH</b> , Skalpelle	11, 12
- Wundhaken	175
- Chirurgische Scheren	33, 64
- Knochenfeilen	256
- Periostotome	212, 213, 218
- Rhinologie	258

## K

<b>KAHN</b> , Chirurgische Scheren	44
<b>KAYE</b> , Feine Scheren	19
<b>KAYE-FACE-LIFT</b> , Chirurgische Scheren	71
<b>KELLY</b> , Chirurgische Scheren	28, 54
- Arterienklemmen	123
<b>KERPEL</b> , Sharfe Löffel	263
<b>KERSCHNER</b> , Mikro Wundhaken	173
<b>KEYES</b> , Rhinologie	263
<b>KILLIAN</b> , Osteotome	225
- Absaugkanülen	295
- Periostotome	211
- Rhinologie	198, 199, 283
<b>KILLIAN-KLAUS</b> , Osteotome	225
<b>KILNER</b> , Wundhaken	172
- Chirurgische Scheren	23, 27, 48, 54
- Wellenschliff Scheren	70
<b>KILNER-DOUGHTY</b> , Mundsperrer	165
<b>KIRBY</b> , Wundhaken	175, 179
<b>KLAR-EVATEUR</b> , Wundhaken	179
<b>KLEINERT-KUTZ</b> , Hohlmeißelzange	273
<b>KNAPP</b> , Mikro Wundhaken	174
<b>KOCHER</b> , Wundhaken	182
- Arterienklemmen	121, 123, 125

Alphabetisches Inhaltsverzeichnis	Alphabetical index	Indice alfabetico	Indice alfabético	Index alphabétiques
<b>KOCHER-OCHSNER</b> , Arterienklemmen		122		
<b>KÖNIG</b> , Elevatorien		205		
<b>KRESSNER</b> , Rhinologie		282		
<b>KUHNT</b> , Chirurgische Pinzetten		100		
<b>L</b>				
<b>LA GRANGE</b> , Feine Scheren		25, 49		
<b>LAMBERT</b> , Mikro Pinzetten		99		
<b>LAMBOTTE</b> , Periostotome - Raspatorien		242		
<b>LANGENBECK</b> , Periostotome		209, 219		
<b>Laryngoskope</b>		3		
<b>LEMPERT</b> , Hohlmeißelzange		271		
<b>LERICHE</b> , Arterienklemmen		119		
<b>LEXER</b> , Osteotome		245		
- Chirurgische Scheren		41, 62		
<b>LEWIS</b> , Knochenfeilen		257		
<b>LICHTENBERG</b> , Nadelhalter		154		
<b>LIEBERMANN-TENNANT</b> , Mikro Wundhaken		173		
<b>Knochenfeilen</b>		253 - 260		
<b>LISTER</b> , Arterienklemmen		114		
<b>LISTON</b> , Hohlmeißelzange		275		
<b>LITTAUER</b> , Cilienpinzetten		106		
<b>LITTLER</b> , Feine Scheren		34		
<b>LOCKLIN</b> , Chirurgische Scheren		24, 28		
<b>LOCKLIN MOD.</b> , Chirurgische Scheren		24		
<b>LOGAN</b> , Wundhaken		191		
<b>LORNA</b> , Tuchklemmen		113		
<b>LOVE</b> , Wundhaken		178		
<b>LUCAE</b> , Chirurgische Hämmer		248		
- Chirurgische Pinzetten		105		
<b>LUENEBURG</b> , Elevatorien		205		
<b>LUER</b> , Wundhaken		178		
- Hohlmeißelzange		272		
<b>M</b>				
<b>MacCOLLUM-DINGMAN</b> , Dissektorien		189		
<b>MAGILL</b> , Absaugkanülen		295		
<b>MAIER</b> , Tamponzange		116		
<b>MALINIAC</b> , Wundhaken		197		
<b>MALTZ</b> , Skalpelle		12		
- Knochenfeilen		259		
- Rhinologie		260		
<b>MARTINI</b> , Sharfe Löffel		261		
<b>Chirurgische Hämmer</b>		249 - 250		
<b>MASING</b> , Skalpelle		12		
- Periostotome		210, 212		
- Rhinologie		233		
<b>MATHIEU</b> , Nadelhalter		154		
<b>MAYO</b> , Chirurgische Scheren		39, 40, 51, 63		
- Sterilisierzange		316		
<b>MAYO-HEGAR</b> , Nadelhalter		142, 146		
<b>MAYO-HEGAR-FINO</b> , Nadelhalter		147		
<b>MAYO-HEGAR-HEANEY</b> , Nadelhalter		146		
<b>MAYO-LEXER</b> , Chirurgische Scheren		63		
<b>MAYO-NOBLE</b> , Chirurgische Scheren		39		
<b>MAYO-STILLE</b> , Chirurgische Scheren		42, 62		
<b>MC DONALD</b> , Periostotome		216		
<b>MC INDOE</b> , Rhinologie		232		
- Atraumatische Pinzetten		98		
<b>MC INTOSH</b> , Set Laryngoskope		3		
<b>MC IVOR</b> , Mundsperrerr		166		
<b>MC KENTY</b> , Periostotome		211, 213		
<b>MC PHERSON</b> , Chirurgische Pinzetten		100		
<b>MEAD</b> , Chirurgische Hämmer		248		
- Periostotome		209		
- Hohlmeißelzange		270		
<b>MEDHORN</b> , Gefäßclips		155		
<b>METZENBAUM</b> , Chirurgische Scheren		33, 35, 36, 48, 50, 58		
- Wellenschliff Scheren		65		
<b>METZENBAUM-FINO</b> , Chirurgische Scheren		35, 36, 53, 59, 60, 61		
<b>MICRO-HALSTED</b> , Feine Arterienklemmen		117		
<b>MICRO-IRIS</b> , Feine Scheren		20		
<b>MICRO-RYDER</b> , Nadelhalter		151, 152		
<b>MICRO-VASCULAR</b> , Nadelhalter		150		
<b>MILLARD</b> , Wundhaken		172, 190		
<b>MILLER</b> , Knochenfeilen		253		
<b>MILLIGAN</b> , Dissektorien - Separatoren		206		
<b>MINI-FRIEDMANN</b> , Hohlmeißelzange		269, 270		
<b>MINI-GILLIES</b> , Nadelhalter		144, 148		
<b>MINI-LAMBOTTE</b> , Osteotome		229		
<b>MINI-LEXER</b> , Osteotome		244		
<b>MINI-MALTZ</b> , Knochenfeilen		259		
<b>MINI-OLSEN-HEGAR</b> , Nadelhalter		143		
<b>MINI-ROUX</b> , Wundhaken		181		
<b>MOD. MARTIN</b> , Watterträger		161		
<b>MODELL WIEN</b> , Nasen Spekula		200		
<b>MOLT</b> , Mundsperrerr		218		
<b>MÜLLER</b> , Approximatoren		157		
<b>N</b>				
<b>NEIVERT</b> , Wundhaken		177		
<b>NELSON-METZENBAUM</b> , Chirurgische Scheren		37		
<b>NEWS</b> , Wundhaken		178		
<b>NOYES</b> , Mikro Scheren		15		
<b>NUBOER</b> , Absaugkanülen		288		
<b>O</b>				
<b>OBWEGESER</b> , Ligaturnadel		159		
- Wundhaken		170, 183		
- Osteotome		247		
- Periostotome		215, 217		
<b>O'BRIEN</b> , Ligatur Scheren		74		
<b>O'CONNOR</b> , Mikro Wundhaken		174		
<b>OLIVECRONA</b> , Dissektorien		207		
- Hohlmeißelzange		272		
<b>OLSEN-HEGAR</b> , Nadelhalter		143, 149		
<b>OMBREDANNE</b> , Chirurgische Hämmer		249		
<b>Osteotome</b>		223 - 248		
<b>ORINGER</b> , Mundsperrerr		169		
<b>OVERHOLT</b> , Arterienklemmen		128		
<b>OVERHOLT-GEISSENDORFER</b> , Arterienklemmen		128		
<b>P</b>				
<b>PARKER-LANGENBECK</b> , Wundhaken		180		
<b>PAR-TYPE</b> , Chirurgische Scheren		54		
<b>PARTSCH</b> , Osteotome - Hohlmeißel		227, 228		
<b>PAPAVERO-HARTMANN</b> , Rhinologie		201		
<b>PAUL</b> , Wundhaken		176		
<b>PEAN</b> , Arterienklemmen		121, 124		
- Feine Arterienklemmen		118		
<b>PEAN-MURPHY</b> , Arterienklemmen		114		
<b>PECK-JOSEPH</b> , Chirurgische Scheren		53		
<b>PEET</b> , Feine Arterienklemmen		111		
<b>PENFIELD</b> , Wundhaken		208		
<b>PENNINGTON</b> , Periostotome		211		
<b>Periostotome</b>		209 - 219		
<b>PERRY</b> , Chirurgische Pinzetten		85		
<b>PIERCE</b> , Periostotome		211		
<b>Arterienklemmen</b>		109 - 130		
<b>Pinzetten</b>		79 - 106		
<b>PITANGUI</b> , Markator		109		
<b>PLESTER</b> , Absaugkanülen		290		
- Wundhaken		194		
<b>Nadelhalter</b>		133 - 154		
<b>POTTS-SMITH</b> , Chirurgische Pinzetten		92, 102		
<b>POTTS-YASARGIL</b> , Mikro Scheren		16		
<b>Q</b>				
<b>QUINBY</b> , Feine Scheren		22		
<b>QUINKE</b> , Nadel für Biopsie		303		
<b>R</b>				
<b>RADOLF</b> , Handchirurgie		280		
<b>RAGNELL</b> , Wundhaken		180		

- Mikro Feine Scheren	19
<b>RAGNELL-DAVIS</b> , Wundhaken	180
<b>RAMPLEY</b> , Tamponzange	116
<b>RANKIN</b> , Arterienklemmen	123
<b>REYNOLDS</b> , Feine Scheren	26
<b>Rhinologie</b>	198 - 201
<b>ROCHESTER-PEAN</b> , Arterienklemmen	122, 129
<b>ROGER</b> , Periostotome	211
<b>ROGGE</b> , Sterilisierzange	315
<b>ROLLET</b> , Mikro Wundhaken	174
<b>ROWE</b> , Knochen Chirurgie	281
<b>ROSE</b> , Wundhaken	178
<b>ROSTKOWSKI</b> , Wundhaken	179
<b>ROUX</b> , Wundhaken	181
<b>ROUX-MAGNUS</b> , Wundhaken	181
<b>RUBIN</b> , Rhinologie	234, 282
<b>RUSKIN</b> , Hohlmeißelzange	273
<b>RUSKIN-LISTON</b> , Hohlmeißelzange	275
<b>RUSKIN-STILLE</b> , Hohlmeißelzange	273
<b>RYDER</b> , Nadelhalter	152

## S

<b>SAALFELD</b> , Sharfe Löffel	262
<b>SACHS</b> , Dissektoren - Separatoren	206
<b>SALZBURG</b> , Periostotome	210
<b>SAROT</b> , Nadelhalter	149
<b>SAUG-RASPATORIUM</b> , Absaugkanülen	289
<b>SCHAEDEL</b> , Tuchklemmen	112
<b>SCHEDE</b> , Sharfe Löffel	264
<b>SCHNEIDER</b> , Periostotome	219
<b>SCHNEIDER-SAUERBRUCH</b> , Periostotome - Raspatorien	242
<b>SCHWECKENDIEK</b> , Tonsillenscheren	43
<b>SCOVILLE</b> , Wundhaken	182
<b>SEDILLOT</b> , Periostotome	214, 219
<b>SEMKEN</b> , Chirurgische Pinzetten	87, 92, 101
<b>SENN-GREEN</b> , Wundhaken	180
<b>SENN-MILLER</b> , Wundhaken	177
<b>SEWALL</b> , Periostotome	212
<b>SHEA</b> , Chirurgische Scheren	33
<b>SHEEHAN</b> , Osteotome	226
<b>SILVER</b> , Rhinologie	232
<b>SIMON</b> , Wundhaken	184
<b>SPENCER</b> , Ligaturschere	74
<b>STACKE</b> , Sonden	160
<b>STEINHÄUSER</b> , Periostotome	217
<b>STELLA</b> , Chirurgische Scheren	68
<b>STELLBRINK</b> , Hohlmeißelzange	269, 271
<b>STEVENS</b> , Feine Scheren	19, 26, 48
<b>STILLE</b> , Chirurgische Scheren	42
- Anatomische Pinzetten	90
<b>STITCH</b> , Feine Scheren	19
<b>Meßinstrumente</b>	4 - 5
<b>SWEDESH MOD.</b> , Nadelhalter	149

## T

<b>TAKAHASHI</b> , Hohlmeißelzange	274
<b>TAYLOR</b> , Chirurgische Pinzetten	102
<b>TENNANT</b> , Chirurgische Pinzetten	100
<b>TESSIER</b> , Osteotome	239, 241
<b>THOREK</b> , Chirurgische Scheren	38
<b>TIECK-HALLE</b> , Nasen Spekula	200
<b>TOBOLD</b> , Zungendrucker	169
<b>TOENNIS</b> , Chirurgische Scheren	38
<b>TOENNIS-ADSON</b> , Chirurgische Scheren	38, 64
<b>TROELTSCH</b> , Chirurgische Pinzetten	105
<b>TUFFIER</b> , Wundhaken	168
<b>TUOHY</b> , Biopsie Kanülen	303

## U

<b>UNIVERSAL</b> , Watterträger	161
<b>UNNA</b> , Sharfe Löffel	262

## V

<b>VANNAS</b> , Mikro Scheren	15
<b>VARADY</b> , Haken Stripper	195
<b>VERESS</b> , Biopsie Nadel	303
<b>VIDAL</b> , Sharfe Löffel	263
<b>WISE</b> , Mikro Pinzetten	79
<b>VOLKMANN</b> , Sharfe Löffel	262, 265

## W

<b>WALTER</b> , Osteotome	231
<b>WALTON</b> , Feine Scheren	19, 34
- Periostotome	213
<b>WANGENSTEEN</b> , Chirurgische Pinzetten	102
<b>WARWICK-JAMES</b> , Eckenzangen	306
<b>WEBSTER</b> , Nadelhalter	145
<b>WEIL-BLAKESLEY</b> , Hohlmeißelzange	274
<b>WEITLANER</b> , Wundhaken	192, 193
<b>WERTHEIMER</b> , Absaugkanülen	293
<b>WEST</b> , Osteotome - Hohlmeißel	228
<b>WESTCOTT</b> , Mikro Scheren	15
<b>WHITEHEAD-JENNINGS</b> , Mundsperrer	165
<b>WIEDER</b> , Zungencrücker	169
<b>WIENER</b> , Mikro Wundhaken	174
<b>WILLIGER</b> , Sharfe Löffel	261, 265
- Elevatoren	205
- Chirurgische Hämmer	248
<b>WILMER</b> , Feine Scheren	22
<b>WULLSTEIN</b> , Wundhaken	192
- Mikro Ohrzängchen	158

## Y

<b>YANCOSKIE</b> , Wundhaken	190
<b>YANKAUER</b> , Dissektoren	206
- Drahtumführungsnadel	159
<b>YASARGIL</b> , Mikro Scheren	16

## Z

<b>ZAUFAL-JANSEN</b> , Hohlmeißelzangen	273
---	-----

**A**

<b>ADSON</b> , Suctions tubes	293
- Retractor	193
- Periosteal	218
- Tissue Forceps	87, 88, 101, 104
<b>ADSON-BROWN</b> , Tissue Forceps	87, 88
<b>ALDERDYCE</b> , Periosteal	209
<b>ALLIS</b> , Gum and Tissue Forceps	110
<b>ALM</b> , Retractors	191
<b>Mouth Gags</b>	165 - 168
<b>ARKANSAS</b> , Accessories for re-sharpening	310
<b>ARRUGA</b> , Needle holders	154
<b>ASCH</b> , Rhinology	282
<b>AUFRIEHT</b> , Retractors	170, 197
- Bone files	257
<b>AUFRIEHT-WALTER</b> , Retractors	170
<b>AUSTIN</b> , Tissue Forceps	86
<b>AXENFELD</b> , Retractors	176
<b>AYERS</b> , Delicate Forceps	99

**B**

<b>BABBUSH</b> , Periosteal	209
<b>BABY-ADSON</b> , Hemostatic Forceps and Ligature	127
<b>BABY-ALLIS</b> , Gum and Tissue Forceps	110
<b>BABY-CRILE</b> , Hemostatic Forceps	120
<b>BABY-CRILE-WOOD</b> , Needle Holders	147
<b>BABY-METZENBAUM</b> , Delicate Scissors	34
<b>BABY-MIXTER</b> , Hemostatic Forceps and Ligature	127
<b>BACKHAUS</b> , Towel Clamps	112
<b>BALLENGER</b> , Osteotome	225
- Knives	12
- Rhinology	238
<b>BALLENGER-HAYEK</b> , Periosteal	211
<b>BARON</b> , Suction Tubes	291
<b>BARRAQUER</b> , Retractors	174
- Micro Needle Holders	134, 136
- Cilia Forceps	106
<b>BARTH</b> , Curettes	261
<b>BEASLEY-BACOCK</b> , Tissue Forceps	87
<b>BEAUPRE</b> , Cilia Forceps	106
<b>BECKMANN</b> , Nasal Specula	200
<b>BEER</b> , Cilia Forceps	106
<b>BELLUCCI</b> , Suction Tubes	291
- Micro Ear forceps	158
<b>BENGOLEA</b> , Hemostatic Forceps	126
<b>BERGMANN</b> , Surgical Mallets	249
<b>BEYER</b> , Bone cutting Forceps	273
<b>BIEMER</b> , Approssimator	157
- Vascular Clamps	155
<b>BIEMER-MÜLLER</b> , Approssimator	157
<b>BIRCHER-GANSKE</b> , Bone surgery	276
<b>BIRKETT</b> , Hemostatic Forceps	126
<b>BIRO</b> , Delicate Scissors	22
<b>BISHOP-HARMON</b> , Micro forceps	100
<b>Knives</b>	6 - 12
<b>BLUMENTHAL</b> , Bone cutting Forceps	270
<b>BÖHLER</b> , Bone cutting Forceps	275
<b>BOIES</b> , Rhinology	283
<b>BONN</b> , Micro Forceps	100
<b>BONNEY</b> , Tissue Forceps	102
<b>BOYNTON</b> , Needle Holders	154
<b>BOWMANN</b> , Probes	160
<b>BRAUN</b> , Hemostatic Forceps	114
<b>BROCK</b> , Micro Scissors	17
- Micro Forceps	81
- Micro Needle Holders	133
<b>BRÜNINGS</b> , Scalpel	12
<b>BRUNS</b> , Curettes	264
<b>BUCKLEY</b> , Osteotome	224
<b>BUNT</b> , Sterilizing Instruments	316

**C**

<b>Suction tubes</b>	287 - 302
----------------------	-----------

<b>CAPLAN</b> , Bone Cutting Scissors	47
- Rhinology	283
<b>CARTER</b> , Periosteal	212
<b>CASPAR</b> , Scalpel handles	9
<b>CASTROVIEJO</b> , Micro Needle Holders	136, 137
- Needle Holders	138, 140
- Measuring Instruments	4
<b>CHADWICK</b> , Delicate Scissors	22
<b>CHEATTLE</b> , Sterilizing Instruments	316
<b>CINELLI</b> , Delicate Scissors	34
- Rhinology	233
<b>COLLIN</b> , Sterilizing Instruments	316
<b>CONVERSE</b> , Scalpel	11
- Retractors	172
- Bone Files	254
- Needle Holders	145
<b>CONWAY</b> , Retractors	179
<b>CORN</b> , Tissue Forceps	86
<b>CORONAL</b> , Retractor	190
<b>COTTLE</b> , Knives	11
- Retractors	172, 175, 177, 179
- Tissue Forceps	23, 46, 64
- Bone files	257
- Surgical Mallets	249
- Micro Forceps	99
- Osteotome	230, 236, 237
- Periosteal	210, 211, 212
- Rhinology	201
- Bone crusher	175
<b>COTTLE-KNAPP</b> , Delicate Scissors	24
<b>COTTLE-MASING</b> , Delicate Scissors	22
<b>COTTLE-NEIVERT</b> , Retractors	175
<b>COTTLE-WALSHAM</b> , Rhinology	282
<b>CRAIG</b> , Rhinology	283
<b>CRILE</b> , Hemostatic Forceps	119, 120
<b>CRILE-MURRAY</b> , Micro Needle Holders	141
<b>CRILE-WOOD</b> , Needle Holders	141, 147, 153
<b>Curettes</b>	261 - 265
<b>CUSHING</b> , Retractors	178, 181, 182
- Periosteal	218
- Tissue Forceps	93, 102
<b>CUSHING-KOCHER</b> , Retractors	182

**D**

<b>DANDY</b> , Operating Scissors	119
<b>DAVIS</b> , Retractors	206
- Sterilizing Instruments	315
<b>DAVIS-BOYLE</b> , Mouth gags	166
<b>DEAN</b> , Serrated Scissors	45
<b>DEAVER</b> , Operating Scissors	32
- Retractors	184
<b>DERF</b> , Needle Holders	141, 145
<b>DESMARRES</b> , Retractors	179
- Isolated Retractor	130
- Micro Forceps	99
<b>DE BAKEY</b> , Atraumatic Forceps	96, 97, 98
- Tissue Forceps	103
- Needle Holders	150
<b>DE MARTEL</b> , Delicate Hemostatic Forceps	111
<b>DIEFFENBACH</b> , Clamps	155
<b>DIETRICH</b> , Needle Holders	138
<b>DINGMANN</b> , Mouth gags	167
- Bone surgery	276
- Bone files	256
<b>Dissector</b>	205 - 208
<b>Retractors</b>	172 - 197
<b>DIXON-LOVELACE</b> , Hemostatic Forceps	126
<b>DOCKHORN</b> , Retractors	171
<b>DUPLAY</b> , Nasal specula	3

**E**

<b>ELSCHNIG</b> , Tissue Forceps	100
<b>EPKER</b> , Osteotome	235

## F

<b>FACE-LIFT</b> , Operating Scissors	67, 69
- Wellenschliff Scissors	70
<b>FAGER</b> , Retractors	206
<b>FARABEUF</b> , Retractors	180
- Periosteal	219
<b>FARABEUF-COLLIN</b> , Raspatories	219
<b>FAULKNER</b> , Rhinology	232
<b>FAURE</b> , Towel Clamps	112
<b>FEICHENFELD</b> , Splinter Forceps	106
<b>FERGUSSON</b> , Suction Tubes	290
<b>FERRIS-SMITH-CUSHING</b> , Bone cutting Forceps	274
<b>FINSEN</b> , Retractors	191
<b>FOERSTER-BALLENGER</b> , Sponge and Dressing Forceps	115
<b>FOMON</b> , Scalpel	11
- Retractors	175
- Operating Scissors	45, 46, 64
- Delicate Scissors	34
- Bone files	255, 259
- Periosteal	213
- Rhinology	233
<b>Scissors</b>	15 - 75
<b>FOSTER-GILLIES</b> , Needle Holders	144
<b>FOX</b> , Curettes	263
<b>FRAZIER</b> , Suction Tubes	290, 293
<b>FREEMAN</b> , Retractors	190
- Operating Scissors	66, 71
- Wellenschliff Scissors	72
<b>FREEMAN-GORNEY</b> , Operating Scissors	66, 71
<b>FREEMAN-KAYE</b> , Operating Scissors	66, 67, 73
<b>FREER</b> , Osteotome	223
- Knives	12
- Micro Retractors	175
- Periosteal	209, 212, 213, 216
<b>FRIEDMANN</b> , Bone cutting Forceps	270, 271

## G

<b>GALLAHER</b> , Bone files	256
<b>GEMINI</b> , Hemostatic Forceps	129
<b>GERALD</b> , Tissue Forceps	95, 104
<b>GERALD-BROWN</b> , Tissue Forceps	95
<b>GIDEF</b> , Delicate Hemostatic Forceps	118
<b>GIESSEN</b> , Retractors	180
<b>GILLIES</b> , Micro Retractors	173
- Atraumatic Forceps	98
- Needle Holders	144, 148
<b>GIUNTA-NASAL</b> , Wellenschliff Scissors	70
<b>GLASSMAN</b> , Operating Scissors	27
<b>GOLDMANN</b> , Rhinology	283
<b>GOLDMAN-FOX</b> , Operating Scissors	25, 49, 53
- Delicate Scissors	25
<b>GOOD</b> , Tonsil Scissors	43
<b>GORNEY</b> , Suction Tubes	289
- Retractor	190
- Operating Scissors	43, 73
- Bone Cutting Scissors	47
- Wellenschliff Scissors	67, 68, 70, 72
<b>GRAEFE</b> , Delicate Scissors	22
- Micro Forceps	99
- Tissue Forceps	86, 100
<b>GREEN</b> , Micro Forceps	99
<b>GREENBERG-PAR</b> , Nasal Scissors	48, 54
<b>GREGORY</b> , Operating Scissors	69
<b>GROSS</b> , Hemostatic Forceps	115
<b>GRUENWALD</b> , Ear Forceps	105
<b>GULLIEN</b> , Suction Tubes	289
<b>GUTHRIE</b> , Micro Retractors	173, 174

## H

<b>HABERER</b> , Retractors	168
<b>HALSEY</b> , Needle Holders	141, 145
<b>HALSTED</b> , Hemostatic Forceps	120
- Delicate Hemostatic Forceps	118

<b>HALSTED-MOSQUITO</b> , Hemostatic Forceps	120
- Delicate Hemostatic Forceps	117
<b>HARRINGTON</b> , Retractors	185
<b>HARTMANN</b> , Tongue Forceps	169
- Suction Tubes	294
- Rhinology	198, 199
- Adult Specula	3
<b>HARTMANN-BABY-MOSQUITO</b> , Delicate Hemostatic Forceps	117
<b>HEANEY(HEGAR)</b> , Needle Holders	142
<b>HEGAR</b> , Needle Holders	142, 146
<b>HEGAR-MAYO-SEELEY</b> , Needle Holders	153
<b>HEISS</b> , Hemostatic Forceps	126
<b>HENAHAN</b> , Periosteal	218
<b>HEYMANN</b> , Operating Scissors	46
<b>HEYMANN-KNIGHT</b> , Operating Scissors	45
<b>HOUSE</b> , Suction Tubes	292
- Retractor	178
<b>HOWARD</b> , Bone files	253
<b>HOWART</b> , Periosteal	211
<b>HUNT</b> , Micro Forceps	99
<b>HUNTER</b> , Splinter Forceps	106

## I

<b>IRIS</b> , Operating Scissors	50, 53
- Delicate Scissors	20
- Left Scissors	52
- Wellenschliff Scissors	65

## J

<b>JACOBSON</b> , Curettes	261
- Micro Scissors	16
- Micro Needle Holders	135
- Needle Holders	139
<b>JACOBSON-MICRO</b> , Delicate Hemostatic Forceps	111
<b>JAEGER</b> , Micro Retractors	174
<b>JAMESON</b> , Operating Scissors	23
<b>JAMESON-WERBER</b> , Operating Scissors	23
<b>JANSEN</b> , Curettes	261
- Bone cutting Forceps	272
- Tissue Forceps	105
- Raspatories	219
<b>JONES</b> , Towel Clamps	112, 114
<b>JOSEPH</b> , Knives	11, 12
- Retractors	175
- Operating Scissors	33, 64
- Bone files	256
- Periosteal	212, 213, 218
- Rhinology	258

## K

<b>KAHN</b> , Operating Scissors	44
<b>KAYE</b> , Delicate Scissors	19
<b>KAYE-FACE-LIFT</b> , Operating Scissors	71
<b>KELLY</b> , Operating Scissors	28, 54
- Hemostatic Forceps	123
<b>KERPEL</b> , Curettes	263
<b>KERSCHNER</b> , Micro Retractors	173
<b>KEYES</b> , Rhinology	263
<b>KILLIAN</b> , Osteotome	225
- Suction Tubes	295
- Periosteal	211
- Rhinology	198, 199, 283
<b>KILLIAN-KLAUS</b> , Osteotome	225
<b>KILNER</b> , Retractors	172
- Operating Scissors	23, 27, 48, 54
- Wellenschliff Scissors	70
<b>KILNER-DOUGHTY</b> , Mouth gags	165
<b>KIRBY</b> , Retractors	175, 179
<b>KLAR-EVATEUR</b> , Retractors	179
<b>KLEINERT-KUTZ</b> , Bone cutting Forceps	273
<b>KNAPP</b> , Micro Retractors	174
<b>KOCHER</b> , Retractors	182
- Hemostatic Forceps	121, 123, 125



Alphabetisches Inhaltsverzeichnis	Alphabetical index	Indice alfabetico	Indice alfabético	Index alphabétiques
<b>KOCHER-OCHSNER</b> , Hemostatic Forceps		122		
<b>KÖNIG</b> , Elevator		205		
<b>KRESSNER</b> , Rhinology		282		
<b>KUHNT</b> , Tissue Forceps		100		
<b>L</b>				
<b>LA GRANGE</b> , Delicate Scissors		25, 49		
<b>LAMBERT</b> , Micro Forceps		99		
<b>LAMBOTTE</b> , Periosteal - Raspatories		242		
<b>LANGENBECK</b> , Periosteal		209, 219		
<b>Laryngoscopes</b>		3		
<b>LEMPERT</b> , Bone cutting Forceps		271		
<b>LERICHE</b> , Hemostatic Forceps		119		
<b>LEXER</b> , Osteotome		245		
- Operating Scissors		41, 62		
<b>LEWIS</b> , Bone files		257		
<b>LICHTENBERG</b> , Needle Holders		154		
<b>LIEBERMANN-TENNANT</b> , Micro Retractors		173		
<b>Bone files</b>		253 - 260		
<b>LISTER</b> , Hemostatic Forceps		114		
<b>LISTON</b> , Bone cutting Forceps		275		
<b>LITTAUER</b> , Cilia Forceps		106		
<b>LITTLER</b> , Delicate Scissors		34		
<b>LOCKLIN</b> , Operating Scissors		24, 28		
<b>LOCKLIN MOD.</b> , Operating Scissors		24		
<b>LOGAN</b> , Retractors		191		
<b>LORNA</b> , Towel clamps		113		
<b>LOVE</b> , Retractors		178		
<b>LUCAE</b> , Surgical Mallets		248		
- Tissue Forceps		105		
<b>LUENEBURG</b> , Elevator		205		
<b>LUER</b> , Bone cutting Forceps		178		
- Bone Cutting Forceps		272		
<b>M</b>				
<b>MacCOLLUM-DINGMAN</b> , Dissector		189		
<b>MAGILL</b> , Suction Tubes		295		
<b>MAIER</b> , Towel Clamps		116		
<b>MALINIAC</b> , Nasal Retractor		197		
<b>MALTZ</b> , Knives		12		
- Bone Files		259		
- Rhinology		260		
<b>MARTINI</b> , Curettes		261		
<b>Surgical Mallets</b>		249 - 250		
<b>MASING</b> , Knives		12		
- Periosteal		210, 212		
- Rhinology		233		
<b>MATHIEU</b> , Needle Holders		154		
<b>MAYO</b> , Operating Scissors		39, 40, 51, 63		
- Sterilizing Instruments		316		
<b>MAYO-HEGAR</b> , Needle Holders		142, 146		
<b>MAYO-HEGAR-FINO</b> , Needle Holders		147		
<b>MAYO-HEGAR-HEANEY</b> , Needle Holders		146		
<b>MAYO-LEXER</b> , Operating Scissors		63		
<b>MAYO-NOBLE</b> , Operating Scissors		39		
<b>MAYO-STILLE</b> , Operating Scissors		42, 62		
<b>MC DONALD</b> , Periosteal		216		
<b>MC INDOE</b> , Rhinology		232		
- Atraumatic Forceps		98		
<b>MC INTOSH</b> , Set Laryngoscopes		3		
<b>MC IVOR</b> , Mouth gags		166		
<b>MC KENTY</b> , Periosteal		211, 213		
<b>MC PHERSON</b> , Tissue Forceps		100		
<b>MEAD</b> , Surgical Mallets		248		
- Periosteal		209		
- Bone cutting Forceps		270		
<b>MEDHORN</b> , Vascular Clamps		155		
<b>METZENBAUM</b> , Operating Scissors		33, 35, 36, 48, 50, 58		
- Wellenschliff Scissors		65		
<b>METZENBAUM-FINO</b> , Operating Scissors		35, 36, 53, 59, 60, 61		
<b>MICRO-HALSTED</b> , Delicate Hemostatic Forceps		117		
<b>MICRO-IRIS</b> , Delicate Scissors		20		
<b>MICRO-RYDER</b> , Needle Holders		151, 152		
<b>MICRO-VASCULAR</b> , Needle Holders		150		
<b>MILLARD</b> , Retractors		172, 190		
<b>MILLER</b> , Bone files		253		
<b>MILLIGAN</b> , Retractors		206		
<b>MINI-FRIEDMANN</b> , Bone cutting Forceps		269, 270		
<b>MINI-GILLIES</b> , Needle Holders		144, 148		
<b>MINI-LAMBOTTE</b> , Osteotome		229		
<b>MINI-LEXER</b> , Osteotome		244		
<b>MINI-MALTZ</b> , Bone Files		259		
<b>MINI-OLSEN-HEGAR</b> , Needle Holders		143		
<b>MINI-ROUX</b> , Retractors		181		
<b>MOD. MARTIN</b> , Cotton Applicators		161		
<b>MODELL WIEN</b> , Nasal Specula		200		
<b>MOLT</b> , Periosteal		218		
<b>MÜLLER</b> , Approximator		157		
<b>N</b>				
<b>NEIVERT</b> , Retractors		177		
<b>NELSON-METZENBAUM</b> , Operating Scissors		37		
<b>NEWS</b> , Retractor		178		
<b>NOYES</b> , Micro Scissors		15		
<b>NUBOER</b> , Suction Tubes		288		
<b>O</b>				
<b>OBWEGESER</b> , Ligature Needle		159		
- Retractors		170, 183		
- Osteotome		247		
- Periosteal		215, 217		
<b>O'BRIEN</b> , Suturing Scissors		74		
<b>O'CONNOR</b> , Micro Retractors		174		
<b>OLIVECRONA</b> , Dissectors		207		
- Bone cutting Forceps		272		
<b>OLSEN-HEGAR</b> , Needle Holder		143, 149		
<b>OMBREDANNE</b> , Surgical Mallets		249		
<b>Osteotome</b>		223 - 248		
<b>ORINGER</b> , Mouth gags		169		
<b>OVERHOLT</b> , Hemostatic Forceps		128		
<b>OVERHOLT-GEISSENDORFER</b> , Hemostatic Forceps		128		
<b>P</b>				
<b>PARKER-LANGENBECK</b> , Retractors		180		
<b>PAR-TYPE</b> , Nasal Scissors		54		
<b>PARTSCH</b> , Osteotome - Gouges		227, 228		
<b>PAPAVERO-HARTMANN</b> , Rhinology		201		
<b>PAUL</b> , Retractors		176		
<b>PEAN</b> , Hemostatic Forceps		121, 124		
- Delicate Hemostatic Forceps		118		
<b>PEAN-MURPHY</b> , Hemostatic Forceps		114		
<b>PECK-JOSEPH</b> , Operating Scissors		53		
<b>PEET</b> , Delicate Hemostatic Forceps		111		
<b>PENFIELD</b> , Retractors		208		
<b>PENNINGTON</b> , Periosteal		211		
<b>Periosteal</b>		209 - 219		
<b>PERRY</b> , Tissue Forceps		85		
<b>PIERCE</b> , Periosteal		211		
<b>Emostatic Forceps</b>		109 - 130		
<b>Forceps</b>		79 - 106		
<b>PITANGUI</b> , Marker		109		
<b>PLESTER</b> , Suction Tubes		290		
- Retractors		194		
<b>Needle Holders</b>		133 - 154		
<b>POTTS-SMITH</b> , Tissue Forceps		92, 102		
<b>POTTS-YASARGIL</b> , Micro Scissors		16		
<b>Q</b>				
<b>QUINBY</b> , Delicate Scissors		22		
<b>QUINKE</b> , Biopsy Needle		303		
<b>R</b>				
<b>RADOLF</b> , Nail Extracting Forceps		280		
<b>RAGNELL</b> , Retractors		180		

- Micro Delicate Scissors	19
<b>RAGNELL-DAVIS</b> , Retractors	180
<b>RAMPLEY</b> , Sponge and Dressing Forceps	116
<b>RANKIN</b> , Hemostatic Forceps	123
<b>REYNOLDS</b> , Delicate Scissors	26
<b>Rhinology</b>	198 - 201
<b>ROCHESTER-PEAN</b> , Hemostatic Forceps	122, 129
<b>ROGER</b> , Periosteal	211
<b>ROGGE</b> , Sterilizing Instruments	315
<b>ROLLET</b> , Micro Retractors	174
<b>ROWE</b> , Bone surgery	281
<b>ROSE</b> , Retractor	178
<b>ROSTKOWSKI</b> , Retractors	179
<b>ROUX</b> , Retractors	181
<b>ROUX-MAGNUS</b> , Retractors	181
<b>RUBIN</b> , Rhinology	234, 282
<b>RUSKIN</b> , Bone cutting Forceps	273
<b>RUSKIN-LISTON</b> , Bone cutting Forceps	275
<b>RUSKIN-STILLE</b> , Bone cutting Forceps	273
<b>RYDER</b> , Needle Holders	152

## S

<b>SAALFELD</b> , Curettes	262
<b>SACHS</b> , Dissectors	206
<b>SALZBURG</b> , Periosteal	210
<b>SAROT</b> , Needle Holders	149
<b>SAUG-RASPATORIUM</b> , Suction Tubes	289
<b>SCHAEDEL</b> , Towel clamps	112
<b>SCHEDE</b> , Curettes	264
<b>SCHNEIDER</b> , Periosteal	219
<b>SCHNEIDER-SAUERBRUCH</b> , Periosteal - Raspatories	242
<b>SCHWACKENDIEK</b> , Tonsil Scissors	43
<b>SCOVILLE</b> , Retractors	182
<b>SEDILLOT</b> , Periosteal	214, 219
<b>SEMKEN</b> , Tissue Forceps	87, 92, 101
<b>SENN-GREEN</b> , Retractors	180
<b>SENN-MILLER</b> , Retractors	177
<b>SEWALL</b> , Periosteal	212
<b>SHEA</b> , Operating Scissors	33
<b>SHEEHAN</b> , Osteotomes	226
<b>SILVER</b> , Rhinology	232
<b>SIMON</b> , Retractors	184
<b>SPENCER</b> , Ligature Scissors	74
<b>STACKE</b> , Probes	160
<b>STEINHÄUSER</b> , Periosteal	217
<b>STELLA</b> , Operating Scissors	68
<b>STELLBRINK</b> , Bone cutting Forceps	269, 271
<b>STEVENS</b> , Delicate Scissors	19, 26, 48
<b>STILLE</b> , Operating Scissors	42
- Dressing Forceps	90
<b>STITCH</b> , Delicate Scissors	19
<b>Measuring Instruments</b>	4 - 5
<b>SWEDESH MOD.</b> , Needle Holders	149

## T

<b>TAKAHASHI</b> , Bone Cutting Forceps	274
<b>TAYLOR</b> , Tissue Forceps	102
<b>TENNANT</b> , Tissue Forceps	100
<b>TESSIER</b> , Osteotome	239, 241
<b>THOREK</b> , Operating Scissors	38
<b>TIECK-HALLE</b> , Nasal Specula	200
<b>TOBOLD</b> , Tongue Forceps	169
<b>TOENNIS</b> , Operating Scissors	38
<b>TOENNIS-ADSON</b> , Operating Scissors	38, 64
<b>TROELTSH</b> , Tissue Forceps	105
<b>TUFFIER</b> , Retractors	168
<b>TUOHY</b> , Biopsy Needle	303

## U

<b>UNIVERSAL</b> , Cotton Applicators	161
<b>UNNA</b> , Curettes	262

## V

<b>VANNAS</b> , Micro Scissors	15
<b>VARADY</b> , Vein Stripper	195
<b>VERESS</b> , Biopsy Needles	303
<b>VIDAL</b> , Curettes	263
<b>WISE</b> , Micro Forceps	79
<b>VOLKMANN</b> , Curettes	262, 265

## W

<b>WALTER</b> , Osteotome	231
<b>WALTON</b> , Delicate Scissors	19, 34
- Periosteal	213
<b>WANGESTEEN</b> , Tissue Forceps	102
<b>WARWICK-JAMES</b> , Nail Scissors	306
<b>WEBSTER</b> , Needle Holders	145
<b>WEIL-BLAKESLEY</b> , Bone cutting Forceps	274
<b>WEITLANER</b> , Retractors	192, 193
<b>WERTHEIMER</b> , Suction Tubes	293
<b>WEST</b> , Osteotome - Gouges	228
<b>WESTCOTT</b> , Micro Scissors	15
<b>WHITEHEAD-JENNINGS</b> , Mouth gags	165
<b>WIEDER</b> , Tongue Forceps	169
<b>WIENER</b> , Micro Retractors	174
<b>WILLIGER</b> , Curettes	261, 265
- Elevator	205
- Surgical Mallets	248
<b>WILMER</b> , Forbici delicate	22
<b>WULLSTEIN</b> , Retractors	192
- Micro Ear forceps	158

## Y

<b>YANCOSKIE</b> , Retractor	190
<b>YANKAUER</b> , Dissector	206
- Wire Guides	159
<b>YASARGIL</b> , Micro Scissors	16

## Z

<b>ZAUFAL-JANSEN</b> , Bone cutting Forceps	273
---	-----

**A**

<b>ADSON</b> , Cannule per aspirazione	293
- Divaricatore	193
- Periostotomo	218
- Pinzette chirurgiche	87, 88, 101, 104
<b>ADSON-BROWN</b> , Pinzette chirurgiche	87, 88
<b>ALDERDYCE</b> , Periostotomi	209
<b>ALLIS</b> , Pinze per tessuti	110
<b>ALM</b> , Divaricatori	191
<b>Apribocca</b>	165 - 168
<b>ARKANSAS</b> , Pietre ed accessori	310
<b>ARRUGA</b> , Port'aghi	154
<b>ASCH</b> , Rinologia	282
<b>AUFRIEHT</b> , Divaricatori	170, 197
- Lime per osso	257
<b>AUFRIEHT-WALTER</b> , Divaricatori	170
<b>AUSTIN</b> , Pinzette chirurgiche	86
<b>AXENFELD</b> , Divaricatori	176
<b>AYERS</b> , Micro Pinzette	99

**B**

<b>BABBUSH</b> , Periostotomi	209
<b>BABY-ADSON</b> , Pinze emostatiche per preparazione e legature	127
<b>BABY-ALLIS</b> , Pinze per tessuti	110
<b>BABY-CRILE</b> , Pinze emostatiche	120
<b>BABY-CRILE-WOOD</b> , Port'aghi	147
<b>BABY-METZENBAUM</b> , Forbici delicate	34
<b>BABY-MIXTER</b> , Pinze emostatiche per preparazione e legature	127
<b>BACKHAUS</b> , Fissateli	112
<b>BALLENGER</b> , Osteotomo	225
- Bisturi	12
- Rinologia	238
<b>BALLENGER-HAYEK</b> , Periostotomo	211
<b>BARON</b> , Cannule per aspirazione	291
<b>BARRAQUER</b> , Divaricatore	174
- Micro Port'aghi	134, 136
- Pinzette depilatorie	106
<b>BARTH</b> , Curette	261
<b>BEASLEY-BACOCK</b> , Pinzetta chirurgica	87
<b>BEAUPRE</b> , Pinzette depilatorie	106
<b>BECKMANN</b> , Speculum nasale	200
<b>BEER</b> , Pinzette depilatorie	106
<b>BELLUCCI</b> , Cannule per aspirazione	291
- Micro Pinze auricolari	158
<b>BENGOLEA</b> , Pinze emostatiche	126
<b>BERGMANN</b> , Martello chirurgico	249
<b>BEYER</b> , Pinze ossivore	273
<b>BIEMER</b> , Approssimatori	157
- Clamps vascolari	155
<b>BIEMER-MÜLLER</b> , Approssimatori	157
<b>BIRCHER-GANSKE</b> , Chirurgia ossea	276
<b>BIRKETT</b> , Pinze emostatiche	126
<b>BIRO</b> , Forbici delicate	22
<b>BISHOP-HARMON</b> , Micro Pinzette	100
<b>Bisturi</b>	6 - 12
<b>BLUMENTHAL</b> , Pinze ossivore	270
<b>BÖHLER</b> , Pinze ossivore	275
<b>BOIES</b> , Rinologia	283
<b>BONN</b> , Micro Pinzette	100
<b>BONNEY</b> , Pinzette chirurgiche	102
<b>BOYNTON</b> , Port'aghi	154
<b>BOWMANN</b> , Sonda bottonute	160
<b>BRAUN</b> , Pinza emostatica	114
<b>BROCK</b> , Micro Forbici	17
- Micro Pinzette	81
- Micro Port'aghi	133
<b>BRÜNING</b> , Bisturi	12
<b>BRUNS</b> , Curette	264
<b>BUCKLEY</b> , Osteotomo	224
<b>BUNT</b> , Pinze per sterilizzazione	316

**C**

<b>Cannule d'aspirazione</b>	287 - 302
------------------------------	-----------

<b>CAPLAN</b> , Forbici ossivore	47
- Rinologia	283
<b>CARTER</b> , Periostotomo	212
<b>CASPAR</b> , Manico per bisturi	9
<b>CASTROVIEJO</b> , Micro Port'aghi	136, 137
- Port'aghi	138, 140
- Strumenti per misurazione	4
<b>CHADWICK</b> , Forbici delicate	22
<b>CHEATTLE</b> , Pinze per sterilizzazione	316
<b>CINELLI</b> , Forbici delicate	34
- Rinologia	233
<b>COLLIN</b> , Pinze per sterilizzazione	316
<b>CONVERSE</b> , Bisturi	11
- Divaricatori	172
- Lime per osso	254
- Port'aghi	145
<b>CONWAY</b> , Divaricatori	179
<b>CORN</b> , Pinzette chirurgiche	86
<b>CORONAL</b> , Divaricatore	190
<b>COTTLE</b> , Bisturi	11
- Divaricatori	172, 175, 177, 179
- Forbici chirurgiche	23, 46, 64
- Lima per osso	257
- Martello chirurgico	249
- Micro Pinzette	99
- Osteotomi	230, 236, 237
- Periostotomi	210, 211, 212
- Rinologia	201
- Strumento per cartilagine	175
<b>COTTLE-KNAPP</b> , Forbici delicate	24
<b>COTTLE-MASING</b> , Forbici delicate	22
<b>COTTLE-NEIVERT</b> , Divaricatore	175
<b>COTTLE-WALSHAM</b> , Rinologia	282
<b>CRAIG</b> , Rinologia	283
<b>CRILE</b> , Pinze emostatiche	119, 120
<b>CRILE-MURRAY</b> , Port'aghi	141
<b>CRILE-WOOD</b> , Port'aghi	141, 147, 153
<b>Curette</b>	261 - 265
<b>CUSHING</b> , Divaricatori	178, 181, 182
- Periostotomo	218
- Pinzette chirurgiche	93, 102
<b>CUSHING-KOCHER</b> , Divaricatore	182

**D**

<b>DANDY</b> , Pinze emostatiche	119
<b>DAVIS</b> , Dissettori - Separatori	206
- Pinze per sterilizzazione	315
<b>DAVIS-BOYLE</b> , Apri bocca	166
<b>DEAN</b> , Forbici chirurgiche	45
<b>DEAVER</b> , Forbici chirurgiche	32
- Divaricatori	184
<b>DERF</b> , Port'aghi	141, 145
<b>DESMARRES</b> , Divaricatori	179
- Divaricatore isolato	130
- Micro Pinzette	99
<b>DE BAKEY</b> , Pinzette atraumatiche	96, 97, 98
- Pinzette chirurgiche	103
- Port'aghi	150
<b>DE MARTEL</b> , Pinza emostatica delicata	111
<b>DIEFFENBACH</b> , Clamps	155
<b>DIETRICH</b> , Port'aghi	138
<b>DINGMANN</b> , Apri bocca	167
- Chirurgia ossea	276
- Lime per osso	256
<b>Dissettori</b>	205 - 208
<b>Divaricatori</b>	172 - 197
<b>DIXON-LOVELACE</b> , Pinze emostatiche	126
<b>DUNN-DAUTREY</b> , Divaricatori	171
<b>DUPLAY</b> , Speculum nasale	3

**E**

<b>ELSCHNIG</b> , Pinzette chirurgiche	100
<b>EPKER</b> , Osteotomi	235

**F**

<b>FACE-LIFT</b> , Forbici chirurgiche	67, 69
- Forbici Wellenschliff	70
<b>FAGER</b> , Dissettori - Separatori	206
<b>FARABEUF</b> , Divaricatore	180
- Periostotomi	219
<b>FARABEUF-COLLIN</b> , Raspatore	219
<b>FAULKNER</b> , Rinologia	232
<b>FAURE</b> , Fissateli	112
<b>FEICHENFELD</b> , Pinzette per frammenti e schegge	106
<b>FERGUSSON</b> , Cannule per aspirazione	290
<b>FERRIS-SMITH-CUSHING</b> , Pinze ossivore	274
<b>FINSEN</b> , Divaricatori	191
<b>FOERSTER-BALLENGER</b> , Pinze per tamponi	115
<b>FOMON</b> , Bisturi	11
- Divaricatori	175
- Forbici chirurgiche	45, 46, 64
- Forbici delicate	34
- Lime per osso	255, 259
- Periostotomo	213
- Rinologia	233
<b>Forbici</b>	15 - 75
<b>FOSTER-GILLIES</b> , Port'aghi	144
<b>FOX</b> , Curette	263
<b>FRAZIER</b> , Cannule per aspirazione	290, 293
<b>FREEMAN</b> , Divaricatori	190
- Forbici chirurgiche	66, 71
- Forbici Wellenschliff	72
<b>FREEMAN-GORNEY</b> , Forbici chirurgiche	66, 71
<b>FREEMAN-KAYE</b> , Forbici chirurgiche	66, 67, 73
<b>FREER</b> , Battitori - Osteotomi	223
- Bisturi	12
- Micro Divaricatore	175
- Periostotomi	209, 212, 213, 216
<b>FRIEDMANN</b> , Pinze ossivore	270, 271

**G**

<b>GALLAHER</b> , Lime per osso	256
<b>GEMINI</b> , Pinze emostatiche	129
<b>GERALD</b> , Pinzette chirurgiche	95, 104
<b>GERALD-BROWN</b> , Pinzette chirurgiche	95
<b>GIDEF</b> , Pinzette emostatiche delicate	118
<b>GIESSEN</b> , Divaricatori	180
<b>GILLIES</b> , Micro divaricatori	173
- Pinzette atraumatiche	98
- Port'aghi	144, 148
<b>GIUNTA-NASAL</b> , Forbici Wellenschliff	70
<b>GLASSMAN</b> , Forbici chirurgiche	27
<b>GOLDMANN</b> , Rinologia	283
<b>GOLDMAN-FOX</b> , Forbici chirurgiche	25, 49, 53
- Forbici delicate	25
<b>GOOD</b> , Forbici per tonsille	43
<b>GORNEY</b> , Cannule per aspirazione	289
- Divaricatore	190
- Forbici chirurgiche	43, 73
- Forbici ossivore	47
- Forbici Wellenschliff	67, 68, 70, 72
<b>GRAEFE</b> , Forbici delicate	22
- Micro Pinzette da fissazione	99
- Pinzette chirurgiche	86, 100
<b>GREEN</b> , Micro Pinzette da fissazione	99
<b>GREENBERG-PAR</b> , Forbici nasali	48, 54
<b>GREGORY</b> , Forbici chirurgiche	69
<b>GROSS</b> , Pinze per tamponi	115
<b>GRÜENWALD</b> , Pinzette auricolari	105
<b>GULLIEN</b> , Cannule per aspirazione	289
<b>GUTHRIE</b> , Micro divaricatori	173, 174

**H**

<b>HABERER</b> , Divaricatori	168
<b>HALSEY</b> , Port'aghi	141, 145
<b>HALSTED</b> , Pinze emostatiche	120
- Pinze emostatiche delicate	118

<b>HALSTED-MOSQUITO</b> , Pinze emostatiche	120
- Pinze emostatiche delicate	117
<b>HARRINGTON</b> , Divaricatori	185
<b>HARTMANN</b> , Abbassa lingua	169
- Cannule per aspirazione	294
- Rinologia	198, 199
- Speculum per adulti	3
<b>HARTMANN-BABY-MOSQUITO</b> , Pinze emostatiche	117
<b>HEANEY(HEGAR)</b> , Port'aghi	142
<b>HEGAR</b> , Port'aghi	142, 146
<b>HEGAR-MAYO-SEELEY</b> , Port'aghi	153
<b>HEISS</b> , Pinze emostatiche	126
<b>HENAHAN</b> , Periostotomo	218
<b>HEYMANN</b> , Forbici chirurgiche	46
<b>HEYMANN-KNIGHT</b> , Forbici chirurgiche	45
<b>HOUSE</b> , Cannule per aspirazione	292
- Divaricatore	178
<b>HOWARD</b> , Lime per osso	253
<b>HOWARTH</b> , Periostotomo	211
<b>HUNT</b> , Micro pinzette	99
<b>HUNTER</b> , Pinzette per frammenti e schegge	106

**I**

<b>IRIS</b> , Forbici chirurgiche	50, 53
- Forbici delicate	20
- Forbici per mancini	52
- Forbici Wellenschliff	65

**J**

<b>JACOBSON</b> , Curette	261
- Micro forbici	16
- Micro Port'aghi	135
- Port'aghi	139
<b>JACOBSON-MICRO</b> , Pinze emostatiche delicate	111
<b>JAEGER</b> , Micro Divaricatori	174
<b>JAMESON</b> , Forbici chirurgiche	23
<b>JAMESON-WERBER</b> , Forbici chirurgiche	23
<b>JANSEN</b> , Curette	261
- Pinze ossivore	272
- Pinzette auricolari	105
- Raspatore	219
<b>JONES</b> , Fissateli	112, 114
<b>JOSEPH</b> , Bisturi	11, 12
- Divaricatore	175
- Forbici chirurgiche	33, 64
- Lime per osso	256
- Periostotomi	212, 213, 218
- Rinologia	258

**K**

<b>KAHN</b> , Forbici chirurgiche	44
<b>KAYE</b> , Forbici delicate	19
<b>KAYE-FACE-LIFT</b> , Forbici chirurgiche	71
<b>KELLY</b> , Forbici chirurgiche	28, 54
- Pinze emostatiche	123
<b>KERPEL</b> , Curette	263
<b>KERSHNER</b> , Micro Divaricatori	173
<b>KEYES</b> , Rinologia	263
<b>KILLIAN</b> , Osteotomo	225
- Cannule per aspirazione	295
- Periostotomo	211
- Rinologia	198, 199, 283
<b>KILLIAN-KLAUS</b> , Osteotomo	225
<b>KILNER</b> , Divaricatori	172
- Forbici chirurgiche	23, 27, 48, 54
- Forbici Wellenschliff	70
<b>KILNER-DOUGHTY</b> , Apri bocca	165
<b>KIRBY</b> , Divaricatori	175, 179
<b>KLAR-EVATEUR</b> , Divaricatore	179
<b>KLEINERT-KUTZ</b> , Pinze ossivore	273
<b>KNAPP</b> , Micro divaricatore	174
<b>KOCHER</b> , Divaricatori	182
- Pinze emostatiche	121, 123, 125

Alphabetisches Inhaltsverzeichnis	Alphabetical index	Indice alfabetico	Indice alfabético	Index alphabétiques
<b>KOCHER-OCHSNER</b> , Pinze emostatiche		122		
<b>KÖNIG</b> , Elevatori		205		
<b>KRESSNER</b> , Rinologia		282		
<b>KUHNT</b> , Pinzette Chirurgiche		100		
<b>L</b>				
<b>LA GRANGE</b> , Forbici delicate		25, 49		
<b>LAMBERT</b> , Micro Pinzette		99		
<b>LAMBOTTE</b> , Periostotomi - Raspatori		242		
<b>LANGENBECK</b> , Periostotomi		209, 219		
<b>Laringoscopi</b>		3		
<b>LEMPERT</b> , Pinze ossivore		271		
<b>LERICHE</b> , Pinze emostatiche		119		
<b>LEXER</b> , Osteotomi		245		
- Forbici chirurgiche		41, 62		
<b>LEWIS</b> , Lime per osso		257		
<b>LICHTENBERG</b> , Port'aghi		154		
<b>LIEBERMANN-TENNANT</b> , Micro Divaricatori		173		
<b>Lime per osso</b>		253 - 260		
<b>LISTER</b> , Pinze emostatiche		114		
<b>LISTON</b> , Pinze ossivore		275		
<b>LITTAUER</b> , Pinzette depilatorie		106		
<b>LITTLER</b> , Forbici delicate		34		
<b>LOCKLIN</b> , Forbici chirurgiche		24, 28		
<b>LOCKLIN MOD.</b> , Forbici chirurgiche		24		
<b>LOGAN</b> , Divaricatori		191		
<b>LORNA</b> , Fissateli		113		
<b>LOVE</b> , Divaricatori		178		
<b>LUCAE</b> , Martello chirurgico		248		
- Pinzette auricolari		105		
<b>LUENEBURG</b> , Elevatori		205		
<b>LUER</b> , Divaricatore		178		
- Pinze ossivore		272		
<b>M</b>				
<b>MacCOLLUM-DINGMAN</b> , Dissettori		189		
<b>MAGILL</b> , Cannule per aspirazione		295		
<b>MAIER</b> , Pinze per tamponi		116		
<b>MALINIAC</b> , Retrattore nasale		197		
<b>MALTZ</b> , Bisturi		12		
- Lime per osso		259		
- Rinologia		260		
<b>MARTINI</b> , Curette		261		
<b>Martelli chirurgici</b>		249 - 250		
<b>MASING</b> , Bisturi		12		
- Periostotomi		210, 212		
- Rinologia		233		
<b>MATHIEU</b> , Port'aghi		154		
<b>MAYO</b> , Forbici chirurgiche		39, 40, 51, 63		
- Pinze per sterilizzazione		316		
<b>MAYO-HEGAR</b> , Port'aghi		142, 146		
<b>MAYO-HEGAR-FINO</b> , Port'aghi		147		
<b>MAYO-HEGAR-HEANEY</b> , Port'aghi		146		
<b>MAYO-LEXER</b> , Forbici chirurgiche		63		
<b>MAYO-NOBLE</b> , Forbici chirurgiche		39		
<b>MAYO-STILLE</b> , Forbici chirurgiche		42, 62		
<b>MC DONALD</b> , Periostotomo		216		
<b>MC INDOE</b> , Rinologia		232		
- Pinze atraumatiche		98		
<b>MC INTOSH</b> , Set laringoscopi		3		
<b>MC IVOR</b> , Apri bocca		166		
<b>MC KENTY</b> , Periostotomi		211, 213		
<b>MC PHERSON</b> , Pinzette chirurgiche		100		
<b>MEAD</b> , Martello chirurgico		248		
- Periostotomo		209		
- Pinze ossivore		270		
<b>MEDHORN</b> , Clamps vascolari		155		
<b>METZENBAUM</b> , Forbici chirurgiche		33, 35, 36, 48, 50, 58		
- Forbici Wellenschliff		65		
<b>METZENBAUM-FINO</b> , Forbici chirurgiche		35, 36, 53, 59, 60, 61		
<b>MICRO-HALSTED</b> , Pinze emostatiche delicate		117		
<b>MICRO-IRIS</b> , Forbici delicate		20		
<b>MICRO-RYDER</b> , Port'aghi		151, 152		
<b>MICRO-VASCULAR</b> , Port'aghi		150		
<b>MILLARD</b> , Divaricatori		172, 190		
<b>MILLER</b> , Lime per osso		253		
<b>MILLIGAN</b> , Dissettori - Separatori		206		
<b>MINI-FRIEDMANN</b> , Pinze ossivore		269, 270		
<b>MINI-GILLIES</b> , Port'aghi		144, 148		
<b>MINI-LAMBOTTE</b> , Osteotomi		229		
<b>MINI-LEXER</b> , Osteotomo		244		
<b>MINI-MALTZ</b> , Lime per osso		259		
<b>MINI-OLSEN-HEGAR</b> , Port'aghi		143		
<b>MINI-ROUX</b> , Divaricatori		181		
<b>MOD. MARTIN</b> , Porta cotone		161		
<b>MODELL WIEN</b> , Speculum nasale		200		
<b>MOLT</b> , Periostotomo		218		
<b>MÜLLER</b> , Approssimatori		157		
<b>N</b>				
<b>NEIVERT</b> , Divaricatori		177		
<b>NELSON-METZENBAUM</b> , Forbici chirurgiche		37		
<b>NEWS</b> , Divaricatore		178		
<b>NOYES</b> , Micro forbici		15		
<b>NUBOER</b> , Cannule per aspirazione		288		
<b>O</b>				
<b>OBWEGESER</b> , Aghi per legature		159		
- Divaricatori		170, 183		
- Osteotomi		247		
- Periostotomi		215, 217		
<b>O'BRIEN</b> , Forbici per suture		74		
<b>O'CONNOR</b> , Divaricatori		174		
<b>OLIVECRONA</b> , Dissettori - Separatori		207		
- Pinze ossivore		272		
<b>OLSEN-HEGAR</b> , Port'aghi		143, 149		
<b>OMBREDANNE</b> , Martello chirurgico		249		
<b>Osteotomi</b>		223 - 248		
<b>ORINGER</b> , Apri bocca		169		
<b>OVERHOLT</b> , Pinze emostatiche		128		
<b>OVERHOLT-GEISSENDORFER</b> , Pinze emostatiche		128		
<b>P</b>				
<b>PARKER-LANGENBECK</b> , Divaricatore		180		
<b>PAR-TYPE</b> , Forbici nasali		54		
<b>PARTSCH</b> , Osteotomi - Scalpelli		227, 228		
<b>PAPAVERO-HARTMANN</b> , Rinologia		201		
<b>PAUL</b> , Divaricatori		176		
<b>PEAN</b> , Pinze emostatiche		121, 124		
- Pinze emostatiche delicate		118		
<b>PEAN-MURPHY</b> , Pinze emostatiche		114		
<b>PECK-JOSEPH</b> , Forbici chirurgiche		53		
<b>PEET</b> , Pinze emostatiche delicate		111		
<b>PENFIELD</b> , Dissettori		208		
<b>PENNINGTON</b> , Periostotomo		211		
<b>Periostotomi</b>		209 - 219		
<b>PERRY</b> , Pinzette per dissezione		85		
<b>PIERCE</b> , Periostotomo		211		
<b>Pinze emostatiche</b>		109 - 130		
<b>Pinzette</b>		79 - 106		
<b>PITANGUI</b> , Marcatore		109		
<b>PLESTER</b> , Cannule per aspirazione		290		
- Divaricatori		194		
<b>Port'aghi</b>		133 - 154		
<b>POTTS-SMITH</b> , Pinzette chirurgiche		92, 102		
<b>POTTS-YASARGIL</b> , Micro forbici		16		
<b>Q</b>				
<b>QUINBY</b> , Forbici delicate		22		
<b>QUINKE</b> , Aghi da biopsia		303		
<b>R</b>				
<b>RADOLF</b> , Chirurgia della mano		280		
<b>RAGNELL</b> , Divaricatori		180		

- Micro Forbici delicate	19
<b>RAGNELL-DAVIS</b> , Divaricatori	180
<b>RAMPLEY</b> , Pinze per tamponi	116
<b>RANKIN</b> , Pinze emostatiche	123
<b>REYNOLDS</b> , Forbici delicate	26
<b>Rinologia</b>	198 - 201
<b>ROCHESTER-PEAN</b> , Pinze emostatiche	122, 129
<b>ROGER</b> , Periostotomo	211
<b>ROGGE</b> , Pinze per sterilizzazione	315
<b>ROLLET</b> , Micro Divaricatori	174
<b>ROWE</b> , Pinze per riposizione	281
<b>ROSE</b> , Divaricatore	178
<b>ROSTKOWSKI</b> , Divaricatori	179
<b>ROUX</b> , Divaricatori	181
<b>ROUX-MAGNUS</b> , Divaricatori	181
<b>RUBIN</b> , Rinologia	234, 282
<b>RUSKIN</b> , Pinze ossivore	273
<b>RUSKIN-LISTON</b> , Pinze ossivore	275
<b>RUSKIN-STILLE</b> , Pinze ossivore	273
<b>RYDER</b> , Port'aghi	152

## S

<b>SAALFELD</b> , Schiaccia comedoni	262
<b>SACHS</b> , Dissettori - Separatori	206
<b>SALZBURG</b> , Periostotomi	210
<b>SAROT</b> , Port'aghi	149
<b>SAUG-RASPATORIUM</b> , Cannule per aspirazione	289
<b>SCHAEDEL</b> , Fissateli	112
<b>SCHEDE</b> , Curette	264
<b>SCHNEIDER</b> , Periostotomo	219
<b>SCHNEIDER-SAUERBRUCH</b> , Periostotomi - Raspatori	242
<b>SCHWACKENDIEK</b> , Forbici per tonsille	43
<b>SCOVILLE</b> , Divaricatori	182
<b>SEDILLOT</b> , Periostotomo	214, 219
<b>SEMKEN</b> , Pinzette chirurgiche	87, 92, 101
<b>SENN-GREEN</b> , Divaricatori	180
<b>SENN-MILLER</b> , Divaricatori	177
<b>SEWALL</b> , Periostotomo	212
<b>SHEA</b> , Forbici chirurgiche	33
<b>SHEEHAN</b> , Osteotomi	226
<b>SILVER</b> , Rinologia	232
<b>SIMON</b> , Divaricatore	184
<b>SPENCER</b> , Forbici per suture	74
<b>STACKE</b> , Sonde bottonute	160
<b>STEINHÄUSER</b> , Periostotomi	217
<b>STELLA</b> , Forbici chirurgiche	68
<b>STELLBRINK</b> , Pinze ossivore	269, 271
<b>STEVENS</b> , Forbici delicate	19, 26, 48
<b>STILLE</b> , Forbici chirurgiche	42
- Pinzette anatomiche	90
<b>STITCH</b> , Forbici delicate	19
<b>Strumenti per misurazione</b>	4 - 5
<b>SWEDESH MOD.</b> , Port'aghi	149

## T

<b>TAKAHASHI</b> , Pinze ossivore	274
<b>TAYLOR</b> , Pinzette chirurgiche	102
<b>TENNANT</b> , Pinzette chirurgiche	100
<b>TESSIER</b> , Osteotomi	239, 241
<b>THOREK</b> , Forbici chirurgiche	38
<b>TIECK-HALLE</b> , Speculum nasale	200
<b>TOBOLD</b> , Abbassalingua	169
<b>TOENNIS</b> , Forbici chirurgiche	38
<b>TOENNIS-ADSON</b> , Forbici chirurgiche	38, 64
<b>TROELTSH</b> , Pinzette auricolari	105
<b>TUFFIER</b> , Divaricatori	168
<b>TUOHY</b> , Aghi da biopsia	303

## U

<b>UNIVERSAL</b> , Porta cotone	161
<b>UNNA</b> , Schiaccia comedoni	262

## V

<b>VANNAS</b> , Micro forbici	15
<b>VARADY</b> , Uncini per vene	195
<b>VERESS</b> , Aghi da biopsia	303
<b>VIDAL</b> , Curette	263
<b>WISE</b> , Micro Pinzette	79
<b>VOLKMANN</b> , Curette	262, 265

## W

<b>WALTER</b> , Osteotomi	231
<b>WALTON</b> , Forbici delicate	19, 34
- Periostotomo	213
<b>WANGESTEEN</b> , Pinzette chirurgiche	102
<b>WARWICK-JAMES</b> , Tronchesi per unghie	306
<b>WEBSTER</b> , Port'aghi	145
<b>WEIL-BLAKESLEY</b> , Pinze ossivore	274
<b>WEITLANER</b> , Divaricatori	192, 193
<b>WERTHEIMER</b> , Cannule per aspirazione	293
<b>WEST</b> , Osteotomi - Scalpelli	228
<b>WESTCOTT</b> , Micro forbici	15
<b>WHITEHEAD-JENNINGS</b> , Apri bocca	165
<b>WIEDER</b> , Abbassalingua	169
<b>WIENER</b> , Micro divaricatori	174
<b>WILLIGER</b> , Curette	261, 265
- Elevatori	205
- Martello chirurgico	248
<b>WILMER</b> , Forbici delicate	22
<b>WULLSTEIN</b> , Divaricatori	192
- Micro Pinze auricolari	158

## Y

<b>YANCOSKIE</b> , Divaricatore	190
<b>YANKAUER</b> , Dissetto	206
- Passafili	159
<b>YASARGIL</b> , Micro forbici	16

## Z

<b>ZAUFAL-JANSEN</b> , Pinze ossivore	273
---------------------------------------	-----

**A**

<b>ADSON</b> , Cánulas aspiradoras	293
- Separadores	193
- Periostotomos	218
- Pinzas quirúrgicas	87, 88, 101, 104
<b>ADSON-BROWN</b> , Pinzas quirúrgicas	87, 88
<b>ALDERDYCE</b> , Periostotomos	209
<b>ALLIS</b> , Pinzas para coger las encias	110
<b>ALM</b> , Separadores	191
<b>Abrebocas</b>	165 - 168
<b>ARKANSAS</b> , Accesorios para el reafilado	310
<b>ARRUGA</b> , Portaaguja	154
<b>ASCH</b> , Rinología	282
<b>AUFRIEHT</b> , Separadores	170, 197
- Limas para huesos	257
<b>AUFRIEHT-WALTER</b> , Separadores	170
<b>AUSTIN</b> , Pinzas quirúrgicas	86
<b>AXENFELD</b> , Separadores	176
<b>AYERS</b> , Pinzas finos	99

**B**

<b>BABBUSH</b> , Periostotomos	209
<b>BABY-ADSON</b> , Pinzas hemostáticas y para ligadura	127
<b>BABY-ALLIS</b> , Pinzas para coger las encias	110
<b>BABY-CRILE</b> , Pinzas hemostáticas	120
<b>BABY-CRILE-WOOD</b> , Portaaguja	147
<b>BABY-METZENBAUM</b> , Tijeras finas	34
<b>BABY-MIXTER</b> , Pinzas hemostáticas y para ligadura	127
<b>BACKHAUS</b> , Pinzas de campo	112
<b>BALLENGER</b> , Batidor - Osteótomos	225
- Bisturios	12
- Rinología	238
<b>BALLENGER-HAYEK</b> , Periostotomos	211
<b>BARON</b> , Cánulas aspiradoras	291
<b>BARRAQUER</b> , Separadores	174
- Micro portaaguja	134, 136
- Pinzas depilatorie	106
<b>BARTH</b> , Cucharillas cortantes	261
<b>BEASLEY-BACOCK</b> , Pinzas quirúrgicas	87
<b>BEAUPRE</b> , Pinzas depilatorie	106
<b>BECKMANN</b> , Espéculos nasales	200
<b>BEER</b> , Pinzas depilatorie	106
<b>BELLUCCI</b> , Cánulas aspiradoras	291
- Pinzas auricolares finas	158
<b>BENGOLEA</b> , Pinzas hemostáticas	126
<b>BERGMANN</b> , Martillos quirúrgicos	249
<b>BEYER</b> , Pinzas para huesos	273
<b>BIEMER</b> , Aproximatores	157
- Clamps vasculares	155
<b>BIEMER-MÜLLER</b> , Aproximatores	157
<b>BIRCHER-GANSKE</b> , Pinzas para Cirugía ósea	276
<b>BIRKETT</b> , Pinzas hemostáticas	126
<b>BIRO</b> , Tijeras finas	22
<b>BISHOP-HARMON</b> , Micro Pinzas	100
<b>Bisturios</b>	6 - 12
<b>BLUMENTHAL</b> , Pinzas para huesos	270
<b>BÖHLER</b> , Pinzas para huesos	275
<b>BOIES</b> , Rinología	283
<b>BONN</b> , Micro Pinzas	100
<b>BONNEY</b> , Pinzas quirúrgicas	102
<b>BOYNTON</b> , Portaaguja	154
<b>BOWMANN</b> , Estiletes	160
<b>BRAUN</b> , Pinzas hemostáticas	114
<b>BROCK</b> , Micro Tijeras	17
- Micro Pinzas	81
- Micro Portaaguja	133
<b>BRÜNINGS</b> , Bisturios	12
<b>BRUNS</b> , Cucharillas cortantes	264
<b>BUCKLEY</b> , Osteótomos	224
<b>BUNT</b> , Pinzas para esterilización	316

**C**

<b>Cánulas aspiradoras</b>	287 - 302
----------------------------	-----------

<b>CAPLAN</b> , Tijeras para huesos	47
- Rinología	283
<b>CARTER</b> , Periostotomos	212
<b>CASPAR</b> , Mango de bisturios	9
<b>CASTROVIEJO</b> , Micro portaaguja	136, 137
- Portaaguja	138, 140
- Instrumentos para medir	4
<b>CHADWICK</b> , Tijeras finas	22
<b>CHEATTLE</b> , Pinzas para esterilización	316
<b>CINELLI</b> , Tijeras finas	34
- Rinología	233
<b>COLLIN</b> , Pinzas para esterilización	316
<b>CONVERSE</b> , Bisturios	11
- Separadores	172
- Limas para huesos	254
- Portaaguja	145
<b>CONWAY</b> , Separadores	179
<b>CORN</b> , Pinzas quirúrgicas	86
<b>CORONAL</b> , Separadores	190
<b>COTTLE</b> , Bisturios	11
- Separadores	172, 175, 177, 179
- Tijeras quirúrgicas	23, 46, 64
- Limas para huesos	257
- Martillos quirúrgicos	249
- Micro Pinzas	99
- Osteótomos	230, 236, 237
- Periostotomos	210, 211, 212
- Rinología	201
- Instrumentos para magullar cartilagos	175
<b>COTTLE-KNAPP</b> , Tijeras finas	24
<b>COTTLE-MASING</b> , Tijeras finas	22
<b>COTTLE-NEIVERT</b> , Separadores	175
<b>COTTLE-WALSHAM</b> , Rinología	282
<b>CRAIG</b> , Rinología	283
<b>CRILE</b> , Pinzas hemostáticas	119, 120
<b>CRILE-MURRAY</b> , Portaaguja	141
<b>CRILE-WOOD</b> , Portaaguja	141, 147, 153
<b>Cucharillas cortantes</b>	261 - 265
<b>CUSHING</b> , Separadores	178, 181, 182
- Periostotomos	218
- Pinzas quirúrgicas	93, 102
<b>CUSHING-KOCHER</b> , Separadores	182

**D**

<b>DANDY</b> , Pinzas hemostáticas	119
<b>DAVIS</b> , Disecadores - Descoladores	206
- Pinzas pala sterilización	315
<b>DAVIS-BOYLE</b> , Abrebocas	166
<b>DEAN</b> , Tijeras quirúrgicas	45
<b>DEAVER</b> , Tijeras quirúrgicas	32
- Separadores	184
<b>DERF</b> , Portaaguja	141, 145
<b>DESMARRES</b> , Separadores	179
- Separadores aislado	130
- Micro Pinzas	99
<b>DE BAKEY</b> , Pinzas atraumáticas	96, 97, 98
- Pinzas quirúrgicas	103
- Portaaguja	150
<b>DE MARTEL</b> , Pinzas hemostáticas finas	111
<b>DIEFFENBACH</b> , Clamps vasculares	155
<b>DIETRICH</b> , Portaaguja	138
<b>DINGMANN</b> , Abrebocas	167
- Pinzas para Cirugía ósea	276
- Limas para huesos	256
<b>Disecadores</b>	205 - 208
<b>Separadores</b>	172 - 197
<b>DIXON-LOVELACE</b> , Pinzas hemostáticas	126
<b>DUNN-DAUTREY</b> , Separadores	171
<b>DUPLAY</b> , Espéculos nasales	3

**E**

<b>ELSCHNIG</b> , Pinzas quirúrgicas	100
<b>EPKER</b> , Osteótomos	235

**F**

<b>FACE-LIFT</b> , Tijeras quirúrgicas	67, 69
- Tijeras Wellenschliff	70
<b>FAGER</b> , Disecadores - Descoladores	206
<b>FARABEUF</b> , Separadores	180
- Periostotomos	219
<b>FARABEUF-COLLIN</b> , Descoladores	219
<b>FAULKNER</b> , Rinología	232
<b>FAURE</b> , Pinzas de campo	112
<b>FEICHENFELD</b> , Pinzas para espinas	106
<b>FERGUSON</b> , Cánulas aspiradoras	290
<b>FERRIS-SMITH-CUSHING</b> , Pinzas para huesos	274
<b>FINSEN</b> , Separadores	191
<b>FOERSTER-BALLENGER</b> , Pinzas para tampones	115
<b>FOMON</b> , Bisturíes	11
- Separadores	175
- Tijeras quirúrgicas	45, 46, 64
- Tijeras finas	34
- Limas para huesos	255, 259
- Periostotomos	213
- Rinología	233
<b>Tijeras</b>	15 - 75
<b>FOSTER-GILLIES</b> , Portaagujas	144
<b>FOX</b> , Cucharillas cortantes	263
<b>FRAZIER</b> , Cánulas aspiradoras	290, 293
<b>FREEMAN</b> , Separadores	190
- Tijeras quirúrgicas	66, 71
- Tijeras Wellenschliff	72
<b>FREEMAN-GORNEY</b> , Tijeras quirúrgicas	66, 71
<b>FREEMAN-KAYE</b> , Tijeras quirúrgicas	66, 67, 73
<b>FREER</b> , Batidor - Osteótomos	223
- Bisturíes	12
- Micro Separadores	175
- Periostotomos	209, 212, 213, 216
<b>FRIEDMANN</b> , Pinzas para huesos	270, 271

**G**

<b>GALLAHER</b> , Limas para huesos	256
<b>GEMINI</b> , Pinzas hemostáticas	129
<b>GERALD</b> , Pinzas quirúrgicas	95, 104
<b>GERALD-BROWN</b> , Pinzas quirúrgicas	95
<b>GIDEF</b> , Pinzas hemostáticas finas	118
<b>GIESSEN</b> , Separadores	180
<b>GILLIES</b> , Micro Separadores	173
- Pinzas Atraumáticas	98
- Portaagujas	144, 148
<b>GIUNTA-NASAL</b> , Tijeras Wellenschliff	70
<b>GLASSMAN</b> , Tijeras quirúrgicas	27
<b>GOLDMANN</b> , Rinología	283
<b>GOLDMAN-FOX</b> , Tijeras quirúrgicas	25, 49, 53
- Tijeras finas	25
<b>GOOD</b> , Tijeras para amígdalas	43
<b>GORNEY</b> , Cánulas aspiradoras	289
- Separadores	190
- Tijeras quirúrgicas	43, 73
- Tijeras para huesos	47
- Tijeras Wellenschliff	67, 68, 70, 72
<b>GRAEFE</b> , Tijeras finas	22
- Micro Pinzas	99
- Pinzas quirúrgicas	86, 100
<b>GREEN</b> , Micro Pinzas	99
<b>GREENBERG-PAR</b> , Tijeras	48, 54
<b>GREGORY</b> , Tijeras quirúrgicas	69
<b>GROSS</b> , Pinzas para tampones	115
<b>GRUENWALD</b> , Pinzas auriculares	105
<b>GUILLIEN</b> , Cánulas aspiradoras	289
<b>GUTHRIE</b> , Micro separadores	173, 174

**H**

<b>HABERER</b> , Separadores	168
<b>HALSEY</b> , Portaagujas	141, 145
<b>HALSTED</b> , Pinzas hemostáticas	120
- Pinzas hemostáticas finas	118

<b>HALSTED-MOSQUITO</b> , Pinzas hemostáticas	120
- Pinzas hemostáticas finas	117
<b>HARRINGTON</b> , Separadores	185
<b>HARTMANN</b> , Bejalenguas	169
- Cánulas aspiradoras	294
- Rinología	198, 199
- Espéculos para adultos	3
<b>HARTMANN-BABY-MOSQUITO</b> , Pinzas hemostáticas	117
<b>HEANEY(HEGAR)</b> , Portaagujas	142
<b>HEGAR</b> , Portaagujas	142, 146
<b>HEGAR-MAYO-SEELEY</b> , Portaagujas	153
<b>HEISS</b> , Pinzas hemostáticas	126
<b>HENAHAN</b> , Periostotomos	218
<b>HEYMANN</b> , Tijeras quirúrgicas	46
<b>HEYMANN-KNIGHT</b> , Tijeras quirúrgicas	45
<b>HOUSE</b> , Cánulas aspiradoras	292
- Separadores	178
<b>HOWARD</b> , Limas para huesos	253
<b>HOWARTH</b> , Periostotomos	211
<b>HUNT</b> , Micro Pinzas	99
<b>HUNTER</b> , Pinzas para espinas	106

**I**

<b>IRIS</b> , Tijeras quirúrgicas	50, 53
- Tijeras finas	20
- Tijeras para zurdos	52
- Tijeras Wellenschliff	65

**J**

<b>JACOBSON</b> , Cucharillas cortante	261
- Micro Tijeras	16
- Micro Portaagujas	135
- Portaagujas	139
<b>JACOBSON-MICRO</b> , Pinzas hemostáticas finas	111
<b>JAEGER</b> , Micro Separadores	174
<b>JAMESON</b> , Tijeras quirúrgicas	23
<b>JAMESON-WERBER</b> , Tijeras quirúrgicas	23
<b>JANSEN</b> , Cucharillos cortantes	261
- Pinzas para huesos	272
- Pinzas auriculares	105
- Descoladores	219
<b>JONES</b> , Pinzas de campo	112, 114
<b>JOSEPH</b> , Bisturíes	11, 12
- Separadores	175
- Tijeras quirúrgicas	33, 64
- Limas para huesos	256
- Periostotomos	212, 213, 218
- Rinología	258

**K**

<b>KAHN</b> , Tijeras quirúrgicas	44
<b>KAYE</b> , Tijeras finas	19
<b>KAYE-FACE-LIFT</b> , Tijeras quirúrgicas	71
<b>KELLY</b> , Tijeras quirúrgicas	28, 54
- Pinzas hemostáticas	123
<b>KERPPEL</b> , Cucharillos cortantes	263
<b>KERSCHNER</b> , Micro Separadores	173
<b>KEYES</b> , Rinología	263
<b>KILLIAN</b> , Osteótomos	225
- Cánulas aspiradoras	295
- Periostotomos	211
- Rinología	198, 199, 283
<b>KILLIAN-KLAUS</b> , Osteótomos	225
<b>KILNER</b> , Separadores	172
- Tijeras quirúrgicas	23, 27, 48, 54
- Tijeras Wellenschliff	70
<b>KILNER-DOUGHTY</b> , Abrebocas	165
<b>KIRBY</b> , Separadores	175, 179
<b>KLAR-EVATEUR</b> , Separadores	179
<b>KLEINERT-KUTZ</b> , Pinzas para huesos	273
<b>KNAPP</b> , Micro Separadores	174
<b>KOCHER</b> , Separadores	182
- Pinzas hemostáticas	121, 123, 125



Alphabetisches Inhaltsverzeichnis	Alphabetical index	Indice alfabetico	Indice alfabético	Index alphabétiques
<b>KOCHER-OCHSNER</b> , Pinzas hemostáticas		122		
<b>KÖNIG</b> , Elevadores		205		
<b>KRESSNER</b> , Rinología		282		
<b>KUHNT</b> , Pinzas quirúrgicas		100		
<b>L</b>				
<b>LA GRANGE</b> , Tijeras finas		25, 49		
<b>LAMBERT</b> , Micro Pinzas		99		
<b>LAMBOTTE</b> , Periostotomos		242		
<b>LANGENBECK</b> , Periostotomos		209, 219		
<b>Laringoscopios</b>		3		
<b>LEMPERT</b> , Pinzas para huesos		271		
<b>LERICHE</b> , Pinzas hemostáticas		119		
<b>LEXER</b> , Osteótomos		245		
- Tijeras quirúrgicas		41, 62		
<b>LEWIS</b> , Limas para huesos		257		
<b>LICHTENBERG</b> , Portaagujas		154		
<b>LIEBERMANN-TENNANT</b> , Micro Separadores		173		
<b>Limas para huesos</b>		253 - 260		
<b>LISTER</b> , Pinzas hemostáticas		114		
<b>LISTON</b> , Pinzas para huesos		275		
<b>LITTAUER</b> , Pinzas depilatorie		106		
<b>LITTLER</b> , Tijeras finas		34		
<b>LOCKLIN</b> , Tijeras quirúrgicas		24, 28		
<b>LOCKLIN MOD.</b> , Tijeras quirúrgicas		24		
<b>LOGAN</b> , Separadores		191		
<b>LORNA</b> , Pinzas de campo		113		
<b>LOVE</b> , Separadores		178		
<b>LUCAE</b> , Martillos quirúrgicos		248		
- Pinzas auriculares		105		
<b>LUENEBURG</b> , Elevadores		205		
<b>LUER</b> , Separadores		178		
- Pinzas para huesos		272		
<b>M</b>				
<b>MacCOLLUM-DINGMAN</b> , Disecadores		189		
<b>MAGILL</b> , Cánulas aspiradoras		295		
<b>MAIER</b> , Pinzas para tampones		116		
<b>MALINIAC</b> , Separadores		197		
<b>MALTZ</b> , Bisturios		12		
- Limas para huesos		259		
- Rinología		260		
<b>MARTINI</b> , Cucharillo cortantes		261		
<b>Martillos quirúrgicos</b>		249 - 250		
<b>MASING</b> , Bisturios		12		
- Periostotomos		210, 212		
- Rinología		233		
<b>MATHIEU</b> , Portaagujas		154		
<b>MAYO</b> , Tijeras quirúrgicas		39, 40, 51, 63		
- Pinzas para esterilización		316		
<b>MAYO-HEGAR</b> , Portaagujas		142, 146		
<b>MAYO-HEGAR-FINO</b> , Portaagujas		147		
<b>MAYO-HEGAR-HEANEY</b> , Portaagujas		146		
<b>MAYO-LEXER</b> , Tijeras quirúrgicas		63		
<b>MAYO-NOBLE</b> , Tijeras quirúrgicas		39		
<b>MAYO-STILLE</b> , Tijeras quirúrgicas		42, 62		
<b>MC DONALD</b> , Periostotomos		216		
<b>MC INDOE</b> , Rinología		232		
- Pinzas Atraumaticas		98		
<b>MC INTOSH</b> , Set Laringoscopios		3		
<b>MC IVOR</b> , Abrebocas		166		
<b>MC KENTY</b> , Periostotomos		211, 213		
<b>MC PHERSON</b> , Pinzas quirúrgicas		100		
<b>MEAD</b> , Martillos quirúrgicos		248		
- Periostotomos		209		
- Pinzas para huesos		270		
<b>MEDHORN</b> , Clamps Vasculares		155		
<b>METZENBAUM</b> , Tijeras quirúrgicas		33, 35, 36, 48, 50, 58		
- Tijeras Wellenschliff		65		
<b>METZENBAUM-FINO</b> , Tijeras quirúrgicas		35, 36, 53, 59, 60, 61		
<b>MICRO-HALSTED</b> , Pinzas hemostáticas finas		117		
<b>MICRO-IRIS</b> , Tijeras finas		20		
<b>MICRO-RYDER</b> , Portaagujas		151, 152		
<b>MICRO-VASCULAR</b> , Portaagujas		150		
<b>MILLARD</b> , Separadores		172, 190		
<b>MILLER</b> , Limas para huesos		253		
<b>MILLIGAN</b> , Disecadores - Descoladores		206		
<b>MINI-FRIEDMANN</b> , Pinzas para huesos		269, 270		
<b>MINI-GILLIES</b> , Portaagujas		144, 148		
<b>MINI-LAMBOTTE</b> , Osteótomos		229		
<b>MINI-LEXER</b> , Osteótomos		244		
<b>MINI-MALTZ</b> , Limas para huesos		259		
<b>MINI-OLSEN-HEGAR</b> , Portaagujas		143		
<b>MINI-ROUX</b> , Separadores		181		
<b>MOD. MARTIN</b> , Porta-algodón		161		
<b>MODELL WIEN</b> , Espéculos nasales		200		
<b>MOLT</b> , Periostótomos		218		
<b>MÜLLER</b> , Approximatores		157		
<b>N</b>				
<b>NEIVERT</b> , Separadores		177		
<b>NELSON-METZENBAUM</b> , Tijeras quirúrgicas		37		
<b>NEWS</b> , Separadores		178		
<b>NOYES</b> , Micro Tijeras		15		
<b>NUBOER</b> , Cánulas aspiradoras		288		
<b>O</b>				
<b>OBWEGESER</b> , Agujas para ligaduras		159		
- Separadores		170, 183		
- Osteótomos		247		
- Periostótomos		215, 217		
<b>O'BRIEN</b> , Tijeras para sutura		74		
<b>O'CONNOR</b> , Micro Separadores		174		
<b>OLIVECRONA</b> , Disecadores - Descoladores		207		
- Pinzas para huesos		272		
<b>OLSEN-HEGAR</b> , Portaagujas		143, 149		
<b>OMBREDANNE</b> , Martillos quirúrgicos		249		
<b>Osteótomos</b>		223 - 248		
<b>ORINGER</b> , Abrebocas		169		
<b>OVERHOLT</b> , Pinzas hemostáticas		128		
<b>OVERHOLT-GEISSENDORFER</b> , Pinzas hemostáticas		128		
<b>P</b>				
<b>PARKER-LANGENBECK</b> , Separadores		180		
<b>PAR-TYPE</b> , Tijeras nasal		54		
<b>PARTSCH</b> , Osteótomos		227, 228		
<b>PAPAVERO-HARTMANN</b> , Espéculos nasale		201		
<b>PAUL</b> , Separadores		176		
<b>PEAN</b> , Pinzas hemostáticas		121, 124		
- Pinzas hemostáticas finas		118		
<b>PEAN-MURPHY</b> , Pinzas hemostáticas		114		
<b>PECK-JOSEPH</b> , Tijeras quirúrgicas		53		
<b>PEET</b> , Pinzas hemostáticas finas		111		
<b>PENFIELD</b> , Disecadores		208		
<b>PENNINGTON</b> , Periostótomos		211		
<b>Periostótomos</b>		209 - 219		
<b>PERRY</b> , Pinzas para disecion		85		
<b>PIERCE</b> , Periostótomos		211		
<b>Pinzas hemostáticas</b>		109 - 130		
<b>Pinzas</b>		79 - 106		
<b>PITANGUI</b> , Marcador		109		
<b>PLESTER</b> , Cánulas aspiradoras		290		
- Separadores		194		
<b>Portaagujas</b>		133 - 154		
<b>POTTS-SMITH</b> , Pinzas quirúrgicas		92, 102		
<b>POTTS-YASARGIL</b> , Micro Tijeras		16		
<b>Q</b>				
<b>QUINBY</b> , Tijeras finas		22		
<b>QUINKE</b> , Agujas para biopsia		303		
<b>R</b>				
<b>RADOLF</b> , Pinza para arrancar uñas		280		
<b>RAGNELL</b> , Separadores		180		

Alphabetisches Inhaltsverzeichnis	Alphabetical index	Indice alfabetico	Indice alfabético	Index alphabétiques
- Micro Tijeras finas		19		
<b>RAGNELL-DAVIS</b> , Separadores		180		
<b>RAMPLEY</b> , Pinzas para tampones		116		
<b>RANKIN</b> , Pinzas hemostáticas		123		
<b>REYNOLDS</b> , Tijeras finas		26		
<b>Rinología</b>		198 - 201		
<b>ROCHESTER-PEAN</b> , Pinzas hemostáticas		122, 129		
<b>ROGER</b> , Periostótomos		211		
<b>ROGGE</b> , Pinzas para esterilización		315		
<b>ROLLET</b> , Micro Separadores		174		
<b>ROWE</b> , Pinze para huesos		281		
<b>ROSE</b> , Separadores		178		
<b>ROSTKOWSKI</b> , Separadores		179		
<b>ROUX</b> , Separadores		181		
<b>ROUX-MAGNUS</b> , Separadores		181		
<b>RUBIN</b> , Rinología		234, 282		
<b>RUSKIN</b> , Pinzas para huesos		273		
<b>RUSKIN-LISTON</b> , Pinzas para huesos		275		
<b>RUSKIN-STILLE</b> , Pinzas para huesos		273		
<b>RYDER</b> , Portaagujas		152		
<b>S</b>				
<b>SAALFELD</b> , Cucharillos cortantes		262		
<b>SACHS</b> , Disecadores - Descoladores		206		
<b>SALZBURG</b> , Periostótomos		210		
<b>SAROT</b> , Portaagujas		149		
<b>SAUG-RASPATORIUM</b> , Cánulas aspiradoras		289		
<b>SCHAEDEL</b> , Pinzas de campo		112		
<b>SCHAEDE</b> , Cucharillos cortantes		264		
<b>SCHNEIDER</b> , Periostótomos		219		
<b>SCHNEIDER-SAUERBRUCH</b> , Periostótomos		242		
<b>SCHWACKENDIEK</b> , Tijeras para amigdales		43		
<b>SCOVILLE</b> , Separadores		182		
<b>SEDILLOT</b> , Periostótomos		214, 219		
<b>SEMKEN</b> , Pinzas quirúrgicas		87, 92, 101		
<b>SENN-GREEN</b> , Separadores		180		
<b>SENN-MILLER</b> , Separadores		177		
<b>SEWALL</b> , Periostótomos		212		
<b>SHEA</b> , Tijeras quirúrgicas		33		
<b>SHEEHAN</b> , Osteótomos		226		
<b>SILVER</b> , Rinología		232		
<b>SIMON</b> , Separadores		184		
<b>SPENCER</b> , Tijeras para ligadura		74		
<b>STACKE</b> , Estiletes		160		
<b>STEINHÄUSER</b> , Periostótomos		217		
<b>STELLA</b> , Tijeras quirúrgicas		68		
<b>STELLBRINK</b> , Pinzas para huesos		269, 271		
<b>STEVENS</b> , Tijeras finas		19, 26, 48		
<b>STILLE</b> , Tijeras quirúrgicas		42		
- Pinzas anatomica		90		
<b>STITCH</b> , Tijeras finas		19		
<b>Instrumentos para medir</b>		4 - 5		
<b>SWEDESH MOD.</b> , Portaagujas		149		
<b>T</b>				
<b>TAKAHASHI</b> , Pinzas para huesos		274		
<b>TAYLOR</b> , Pinzas quirúrgicas		102		
<b>TENNANT</b> , Pinzas quirúrgicas		100		
<b>TESSIER</b> , Osteótomos		239, 241		
<b>THOREK</b> , Tijeras quirúrgicas		38		
<b>TIECK-HALLE</b> , Espéculos nasales		200		
<b>TOBOLD</b> , Bejalenguas		169		
<b>TOENNIS</b> , Tijeras quirúrgicas		38		
<b>TOENNIS-ADSON</b> , Tijeras quirúrgicas		38, 64		
<b>TROELTSH</b> , Pinzas auricolaires		105		
<b>TUFFIER</b> , Separadores		168		
<b>TUOHY</b> , Agujas para biopsia		303		
<b>U</b>				
<b>UNIVERSAL</b> , Porta-algodón		161		
<b>UNNA</b> , cucharillos cortantes		262		
<b>V</b>				
<b>VANNAS</b> , Micro Tijeras		15		
<b>VARADY</b> , Instrumentos para vârices		195		
<b>VERESS</b> , Agujas para biopsia		303		
<b>VIDAL</b> , Cucharillos cortantes		263		
<b>WISE</b> , Micro Pinzas		79		
<b>VOLKMANN</b> , Cucharillos cortantes		262, 265		
<b>W</b>				
<b>WALTER</b> , Osteótomos		231		
<b>WALTON</b> , Tijeras finas		19, 34		
- Periostótomos		213		
<b>WANGESTEEN</b> , Pinzas quirúrgicas		102		
<b>WARWICK-JAMES</b> , Instrumentos para pedicure		306		
<b>WEBSTER</b> , Portaagujas		145		
<b>WEIL-BLAKESLEY</b> , Pinzas para huesos		274		
<b>WEITLANER</b> , Separadores		192, 193		
<b>WERTHEIMER</b> , Cánulas aspiradoras		293		
<b>WEST</b> , Osteótomos		228		
<b>WESTCOTT</b> , Micro Tijeras		15		
<b>WHITEHEAD-JENNINGS</b> , Abrebocas		165		
<b>WIEDER</b> , Bejalenguas		169		
<b>WIENER</b> , Micro Separadores		174		
<b>WILLIGER</b> , Cucharillos cortantes		261, 265		
- Elevadores		205		
- Martillos quirúrgicos		248		
<b>WILMER</b> , Tijeras finas		22		
<b>WULLSTEIN</b> , Separadores		192		
- Pinzas auricolares finas		158		
<b>Y</b>				
<b>YANCOSKIE</b> , Separadores		190		
<b>YANKAUER</b> , Disecadores		206		
- Agujas para ligaduras		159		
<b>YASARGIL</b> , Micro Tijeras		16		
<b>Z</b>				
<b>ZAUFAL-JANSEN</b> , Pinzas para huesos		273		

**A**

<b>ADSON</b> , Canules aspiratrices	293
- Ecarteur	193
- Rugines	218
- Pincés chirurgiques	87, 88, 101, 104
<b>ADSON-BROWN</b> , Pincés chirurgiques	87, 88
<b>ALDERDYCE</b> , Rugines	209
<b>ALLIS</b> , Pincés pour saisir les tissue	110
<b>ALM</b> , Ecarteurs	191
<b>Ecarteurs buccal</b>	165 - 168
<b>ARKANSAS</b> , Pierres d'affutage	310
<b>ARRUGA</b> , Porte aiguilles	154
<b>ASCH</b> , Rhinologie	282
<b>AUFRIEHT</b> , Ecarteurs	170, 197
- Limes à os	257
<b>AUFRIEHT-WALTER</b> , Ecarteurs	170
<b>AUSTIN</b> , Pincés chirurgiques	86
<b>AXENFELD</b> , Ecarteurs	176
<b>AYERS</b> , Micro pincés	99

**B**

<b>BABBUSH</b> , Rugines	209
<b>BABY-ADSON</b> , Pincés hemostatiques et à ligatures	127
<b>BABY-ALLIS</b> , Pincés pour saisir les tissue	110
<b>BABY-CRILE</b> , Pincés hemostatiques	120
<b>BABY-CRILE-WOOD</b> , Porte aiguilles	147
<b>BABY-METZENBAUM</b> , Ciseaux délicate	34
<b>BABY-MIXTER</b> , Pincés hemostatiques et à ligatures	127
<b>BACKHAUS</b> , Pincés pour fixer les compresses	112
<b>BALLENGER</b> , Ostéotomes	225
- Bistouris	12
- Rhinologie	238
<b>BALLENGER-HAYEK</b> , Rugines	211
<b>BARON</b> , Canules aspiratrices	291
<b>BARRAQUER</b> , Ecarteurs	174
- Micro porte aiguilles	134, 136
- Pincés à épiler	106
<b>BARTH</b> , Curettes	261
<b>BEASLEY-BACOCK</b> , Pincés chirurgiques	87
<b>BEAUPRE</b> , Pincés à épiler	106
<b>BECKMANN</b> , Spéculums nasaux	200
<b>BEER</b> , Pincés à épiler	106
<b>BELLUCCI</b> , Canules aspiratrices	291
- Micro Pincés auriculaires	158
<b>BENGOLEA</b> , Pincés hemostatiques	126
<b>BERGMANN</b> , Maillets chirurgiques	249
<b>BEYER</b> , Pincés à os	273
<b>BIEMER</b> , Approximateurs	157
- Clamps vasculaires	155
<b>BIEMER-MÜLLER</b> , Approximateurs	157
<b>BIRCHER-GANSKE</b> , Pincés pour chirurgie osseuse	276
<b>BIRKETT</b> , Pincés hemostatiques	126
<b>BIRO</b> , Ciseaux délicate	22
<b>BISHOP-HARMON</b> , Micro Pincés	100
<b>Bistouris</b>	6 - 12
<b>BLUMENTHAL</b> , Pincés à os	270
<b>BÖHLER</b> , Pincés à os	275
<b>BOIES</b> , Rhinologie	283
<b>BONN</b> , Micro Pincés	100
<b>BONNEY</b> , Pincés chirurgiques	102
<b>BOYNTON</b> , Porte aiguilles	154
<b>BOWMANN</b> , Sondes	160
<b>BRAUN</b> , Pincés hemostatiques	114
<b>BROCK</b> , Micro Ciseaux	17
- Micro Pincés	81
- Micro Porte aiguilles	133
<b>BRÜNINGS</b> , Bistouris	12
<b>BRUNS</b> , Curettes tranchantes	264
<b>BUCKLEY</b> , Ostéotomes	224
<b>BUNT</b> , Pincés à stérilisation	316

**C**

<b>Canules aspiratrices</b>	287 - 302
-----------------------------	-----------

<b>CAPLAN</b> , Ciseaux à os	47
- Rhinologie	283
<b>CARTER</b> , Rugines	212
<b>CASPAR</b> , Manche de bistouris	9
<b>CASTROVIEJO</b> , Micro porte aiguilles	136, 137
- Porte aiguilles	138, 140
- Instruments à mesurer	4
<b>CHADWICK</b> , Ciseaux délicate	22
<b>CHEATTLE</b> , Pincés à stérilisation	316
<b>CINELLI</b> , Ciseaux délicate	34
- Rhinologie	233
<b>COLLIN</b> , Pincés à stérilisation	316
<b>CONVERSE</b> , Bistouris	11
- Ecarteurs	172
- Lime à os	254
- Porte aiguilles	145
<b>CONWAY</b> , Ecarteurs	179
<b>CORN</b> , Pincés chirurgiques	86
<b>CORONAL</b> , Ecarteur	190
<b>COTTLE</b> , Bistouris	11
- Ecarteurs	172, 175, 177, 179
- Ciseaux chirurgiques	23, 46, 64
- Limes à os	257
- Maillets chirurgiques	249
- Micro pincés	99
- Osteotomes	230, 236, 237
- Rugines	210, 211, 212
- Rhinologie	201
- Instruments à écraser le cartilage	175
<b>COTTLE-KNAPP</b> , Ciseaux délicate	24
<b>COTTLE-MASING</b> , Ciseaux délicate	22
<b>COTTLE-NEIVERT</b> , Ecarteurs	175
<b>COTTLE-WALSHAM</b> , Rhinologie	282
<b>CRAIG</b> , Rhinologie	283
<b>CRILE</b> , Pincés hemostatiques	119, 120
<b>CRILE-MURRAY</b> , Porte aiguilles	141
<b>CRILE-WOOD</b> , Porte aiguilles	141, 147, 153
<b>Curettes</b>	261 - 265
<b>CUSHING</b> , Ecarteurs	178, 181, 182
- Rugines	218
- Pincés chirurgiques	93, 102
<b>CUSHING-KOCHER</b> , Ecarteurs	182

**D**

<b>DANDY</b> , Pincés hemostatiques	119
<b>DAVIS</b> , Dissecteurs - Separateurs	206
- Pincés à stérilisation	315
<b>DAVIS-BOYLE</b> , Ecarteur buccal	166
<b>DEAN</b> , Ciseaux chirurgiques	45
<b>DEAVER</b> , Ciseaux chirurgiques	32
- Ecarteurs	184
<b>DERF</b> , Porte aiguilles	141, 145
<b>DESMARRES</b> , Ecarteurs	179
- Ecarteur à enduit plastique isolant	130
- Micro Pincés	99
<b>DE BAKEY</b> , Pincés atraumatiques	96, 97, 98
- Pincés chirurgiques	103
- Porte aiguilles	150
<b>DE MARTEL</b> , Pincés hemostatiques	111
<b>DIEFFENBACH</b> , Clamps	155
<b>DIETRICH</b> , Porte aiguilles	138
<b>DINGMANN</b> , Ecarteur buccal	167
- Pincés pour chirurgie osseuse	276
- Limes à os	256
<b>Dissecteurs</b>	205 - 208
<b>Ecarteurs</b>	172 - 197
<b>DIXON-LOVELACE</b> , Pincés hemostatiques	126
<b>DUNN-DAUTREY</b> , Ecarteurs	171
<b>DUPLAY</b> , Spéculums nasaux	3

**E**

<b>ELSCHNIG</b> , Pincés chirurgiques	100
<b>EPKER</b> , Osteotomes	235

**F**

<b>FACE-LIFT</b> , Ciseaux chirurgiques	67, 69
- Ciseaux Wellenschliff	70
<b>FAGER</b> , Dissecteur - Separateurs	206
<b>FARABEUF</b> , Ecarteurs	180
- Rugines	219
<b>FARABEUF-COLLIN</b> , Rugines	219
<b>FAULKNER</b> , Rhinologie	232
<b>FAURE</b> , Pincés pour fixer les compresses	112
<b>FEICHENFELD</b> , Pincés à échardes	106
<b>FERGUSSON</b> , Canules aspiratrices	290
<b>FERRIS-SMITH-CUSHING</b> , Pincés à os	274
<b>FINSEN</b> , Ecarteurs	191
<b>FOERSTER-BALLENGER</b> , Pincés à tampons	115
<b>FOMON</b> , Bistouris	11
- Ecarteurs	175
- Ciseaux chirurgiques	45, 46, 64
- Ciseaux délicate	34
- Limes à os	255, 259
- Rugines	213
- Rhinologie	233
<b>Ciseaux</b>	15 - 75
<b>FOSTER-GILLIES</b> , Porte aiguilles	144
<b>FOX</b> , Curettes	263
<b>FRAZIER</b> , Canules aspiratrices	290, 293
<b>FREEMAN</b> , Ecarteurs	190
- Ciseaux chirurgiques	66, 71
- Ciseaux Wellenschliff	72
<b>FREEMAN-GORNEY</b> , Ciseaux chirurgiques	66, 71
<b>FREEMAN-KAYE</b> , Ciseaux chirurgiques	66, 67, 73
<b>FREER</b> , Pylons - Ostéotomes	223
- Bistouris	12
- Micro Ecarteurs	175
- Rugines	209, 212, 213, 216
<b>FRIEDMANN</b> , Pincés à os	270, 271

**G**

<b>GALLAHER</b> , Limes à os	256
<b>GEMINI</b> , Pincés hémostatiques	129
<b>GERALD</b> , Pincés chirurgiques	95, 104
<b>GERALD-BROWN</b> , Pincés chirurgiques	95
<b>GIDEF</b> , Pincés hémostatiques délicate	118
<b>GIESSEN</b> , Ecarteurs	180
<b>GILLIES</b> , Micro ecarteurs	173
- Pincés atraumatiques	98
- Porte aiguilles	144, 148
<b>GIUNTA-NASAL</b> , Ciseaux Wellenschliff	70
<b>GLASSMAN</b> , Ciseaux chirurgiques	27
<b>GOLDMANN</b> , Rhinologie	283
<b>GOLDMAN-FOX</b> , Ciseaux chirurgiques	25, 49, 53
- Ciseaux délicate	25
<b>GOOD</b> , Ciseaux pour les amygdales	43
<b>GORNEY</b> , Canules aspiratrices	289
- Ecarteur	190
- Ciseaux chirurgiques	43, 73
- Ciseaux à os	47
- Ciseaux Wellenschliff	67, 68, 70, 72
<b>GRAEFE</b> , Ciseaux délicate	22
- Micro Pincés	99
- Pincés chirurgiques	86, 100
<b>GREEN</b> , Micro Pincés	99
<b>GREENBERG-PAR</b> , Ciseaux nasaux	48, 54
<b>GREGORY</b> , Ciseaux chirurgiques	69
<b>GROSS</b> , Pincés à tampons	115
<b>GRUENWALD</b> , Pincés auriculaires	105
<b>GULLIEN</b> , Canules aspiratrices	289
<b>GUTHRIE</b> , Micro ecarteurs	173, 174

**H**

<b>HABERER</b> , Ecarteurs	168
<b>HALSEY</b> , Porte aiguilles	141, 145
<b>HALSTED</b> , Pincés hémostatiques	120
- Pincés hémostatiques délicate	118

<b>HALSTED-MOSQUITO</b> , Pincés hémostatiques	120
- Pincés hémostatiques délicate	117
<b>HARRINGTON</b> , Ecarteurs	185
<b>HARTMANN</b> , Abaisse langue	169
- Canules aspiratrices	294
- Rhinologie	198, 199
- Spéculums pour adultes	3
<b>HARTMANN-BABY-MOSQUITO</b> , Pincés hémostatiques	117
<b>HEANEY(HEGAR)</b> , Porte aiguilles	142
<b>HEGAR</b> , Porte aiguilles	142, 146
<b>HEGAR-MAYO-SEELEY</b> , Porte aiguilles	153
<b>HEISS</b> , Pincés hémostatiques	126
<b>HENAHAN</b> , Rugines	218
<b>HEYMANN</b> , Ciseaux chirurgiques	46
<b>HEYMANN-KNIGHT</b> , Ciseaux chirurgiques	45
<b>HOUSE</b> , Canules aspiratrices	292
- Ecarteur	178
<b>HOWARD</b> , Limes à os	253
<b>HOWARTH</b> , Rugines	211
<b>HUNT</b> , Micro pincés	99
<b>HUNTER</b> , Pincés à échardes	106

**I**

<b>IRIS</b> , Ciseaux chirurgiques	50, 53
- Ciseaux délicate	20
- Gauche Ciseaux	52
- Ciseaux Wellenschliff	65

**J**

<b>JACOBSON</b> , Curettes tranchantes	261
- Micro Ciseaux	16
- Micro porte aiguilles	135
- Porte aiguilles	139
<b>JACOBSON-MICRO</b> , Pincés hémostatiques délicate	111
<b>JAEGER</b> , Micro Ecarteurs	174
<b>JAMESON</b> , Ciseaux chirurgiques	23
<b>JAMESON-WERBER</b> , Ciseaux chirurgiques	23
<b>JANSEN</b> , Curettes tranchantes	261
- Pincés à os	272
- Pincés auriculaires	105
- Rugines	219
<b>JONES</b> , Pincés pour fixer les compresses	112, 114
<b>JOSEPH</b> , Bistouris	11, 12
- Ecarteurs	175
- Ciseaux chirurgiques	33, 64
- Limes à os	256
- Rugines	212, 213, 218
- Rhinologie	258

**K**

<b>KAHN</b> , Ciseaux chirurgiques	44
<b>KAYE</b> , Ciseaux délicate	19
<b>KAYE-FACELIFT</b> , Ciseaux chirurgiques	71
<b>KELLY</b> , Ciseaux chirurgiques	28, 54
- Pincés hémostatiques	123
<b>KERPEL</b> , Curettes tranchantes	263
<b>KERSCHNER</b> , Micro Ecarteurs	173
<b>KEYES</b> , Rhinologie	263
<b>KILLIAN</b> , Osteotomes	225
- Canules aspiratrices	295
- Rugines	211
- Rhinologie	198, 199, 283
<b>KILLIAN-KLAUS</b> , Osteotomes	225
<b>KILNER</b> , Ecarteurs	172
- Ciseaux chirurgiques	23, 27, 48, 54
- Ciseaux Wellenschliff	70
<b>KILNER-DOUGHTY</b> , Ecarteur buccal	165
<b>KIRBY</b> , Ecarteurs	175, 179
<b>KLAR-EVATEUR</b> , Ecarteurs	179
<b>KLEINERT-KUTZ</b> , Pincés à os	273
<b>KNAPP</b> , Micro ecarteurs	174
<b>KOCHER</b> , Ecarteurs	182
- Pincés hémostatiques	121, 123, 125

Alphabetisches Inhaltsverzeichnis	Alphabetical index	Indice alfabetico	Indice alfabético	Index alphabétiques
<b>KOCHER-OCHSNER</b> , Pincés hemostáticas		122		
<b>KÖNIG</b> , Elevateur		205		
<b>KRESSNER</b> , Rhinologie		282		
<b>KUHNT</b> , Pincés chirurgiques		100		
<b>L</b>				
<b>LA GRANGE</b> , Ciseaux délicate		25, 49		
<b>LAMBERT</b> , Micro Pincés		99		
<b>LAMBOTTE</b> , Rugines à periostomie		242		
<b>LANGENBECK</b> , Rugines		209, 219		
<b>Laryngoscopes</b>		3		
<b>LEMPERT</b> , Pincés à os		271		
<b>LERICHE</b> , Pincés hemostáticas		119		
<b>LEXER</b> , Ostéotomes		245		
- Ciseaux chirurgiques		41, 62		
<b>LEWIS</b> , Limes à os		257		
<b>LICHTENBERG</b> , Porte aiguilles		154		
<b>LIEBERMANN-TENNANT</b> , Micro Ecarteurs		173		
<b>Lime à os</b>		253 - 260		
<b>LISTER</b> , Pincés hemostáticas		114		
<b>LISTON</b> , Pincés à os		275		
<b>LITTAUER</b> , Pincés à épiler		106		
<b>LITTLER</b> , Ciseaux délicate		34		
<b>LOCKLIN</b> , Ciseaux chirurgiques		24, 28		
<b>LOCKLIN MOD.</b> , Ciseaux chirurgiques		24		
<b>LOGAN</b> , Ecarteurs		191		
<b>LORNA</b> , Pincés pour fixer les compresses		113		
<b>LOVE</b> , Ecarteurs		178		
<b>LUCAE</b> , Maillets chirurgiques		248		
- Pincés auriculaires		105		
<b>LUENEBURG</b> , Elevateur		205		
<b>LUER</b> , Ecarteur		178		
- Pincés à os		272		
<b>M</b>				
<b>MacCOLLUM-DINGMAN</b> , Dissecteur		189		
<b>MAGILL</b> , Canules aspiratrices		295		
<b>MAIER</b> , Pincés à tampons		116		
<b>MALINIAC</b> , Ecarteurs nasaux		197		
<b>MALTZ</b> , Bistouris		12		
- Lime à os		259		
- Rhinologie		260		
<b>MARTINI</b> , Curettes tranchantes		261		
<b>Maillets chirurgiques</b>		249 - 250		
<b>MASING</b> , Bistouris		12		
- Rugines		210, 212		
- Rhinologie		233		
<b>MATHIEU</b> , Porte aiguilles		154		
<b>MAYO</b> , Ciseaux chirurgiques		39, 40, 51, 63		
- Pincés à stérilisation		316		
<b>MAYO-HEGAR</b> , Porte aiguilles		142, 146		
<b>MAYO-HEGAR-FINO</b> , Porte aiguilles		147		
<b>MAYO-HEGAR-HEANEY</b> , Porte aiguilles		146		
<b>MAYO-LEXER</b> , Ciseaux chirurgiques		63		
<b>MAYO-NOBLE</b> , Ciseaux chirurgiques		39		
<b>MAYO-STILLE</b> , Ciseaux chirurgiques		42, 62		
<b>MC DONALD</b> , Rugines		216		
<b>MC INDOE</b> , Rhinologie		232		
- Pincés Atraumatiques		98		
<b>MC INTOSH</b> , Set Laryngoscopes		3		
<b>MC IVOR</b> , Ecarteur buccal		166		
<b>MC KENTY</b> , Rugines		211, 213		
<b>MC PHERSON</b> , Pincés chirurgiques		100		
<b>MEAD</b> , Maillets chirurgiques		248		
- Rugines		209		
- Pincés à os		270		
<b>MEDHORN</b> , Clamps vasculaires		155		
<b>METZENBAUM</b> , Ciseaux chirurgiques		33, 35, 36, 48, 50, 58		
- Ciseaux Wellenschliff		65		
<b>METZENBAUM-FINO</b> , Ciseaux chirurgiques		35, 36, 53, 59, 60, 61		
<b>MICRO-HALSTED</b> , Pincés hemostáticas délicate		117		
<b>MICRO-IRIS</b> , Ciseaux délicate		20		
<b>MICRO-RYDER</b> , Porte aiguilles		151, 152		
<b>MICRO-VASCULAR</b> , Porte aiguilles		150		
<b>MILLARD</b> , Ecarteurs		172, 190		
<b>MILLER</b> , Limes à os		253		
<b>MILLIGAN</b> , Dissecteur - Separateur		206		
<b>MINI-FRIEDMANN</b> , Pincés à os		269, 270		
<b>MINI-GILLIES</b> , Porte aiguilles		144, 148		
<b>MINI-LAMBOTTE</b> , Ostéotomes		229		
<b>MINI-LEXER</b> , Ostéotomes		244		
<b>MINI-MALTZ</b> , Lime à os		259		
<b>MINI-OLSEN-HEGAR</b> , Porte aiguilles		143		
<b>MINI-ROUX</b> , Ecarteurs		181		
<b>MOD. MARTIN</b> , Porte coton		161		
<b>MODELL WIEN</b> , Spéculums nasaux		200		
<b>MOLT</b> , Rugines		218		
<b>MÜLLER</b> , Approximateur		157		
<b>N</b>				
<b>NEIVERT</b> , Ecarteurs		177		
<b>NELSON-METZENBAUM</b> , Ciseaux chirurgiques		37		
<b>NEWS</b> , Ecarteur		178		
<b>NOYES</b> , Micro Ciseaux		15		
<b>NUBOER</b> , Canules aspiratrices		288		
<b>O</b>				
<b>OBWEGESER</b> , Aiguilles pour ligatures		159		
- Ecarteurs		170, 183		
- Ostéotomes		247		
- Rugines		215, 217		
<b>O'BRIEN</b> , Ciseaux à ligatures		74		
<b>O'CONNOR</b> , Micro Ecarteurs		174		
<b>OLIVECRONA</b> , Dissecteur - Separateur		207		
- Pincés à os		272		
<b>OLSEN-HEGAR</b> , Porte aiguilles		143, 149		
<b>OMBREDANNE</b> , Maillets chirurgiques		249		
<b>Ostéotomes</b>		223 - 248		
<b>ORINGER</b> , Ecarteur buccal		169		
<b>OVERHOLT</b> , Pincés hemostáticas		128		
<b>OVERHOLT-GEISSENDORFER</b> , Pincés hemostáticas		128		
<b>P</b>				
<b>PARKER-LANGENBECK</b> , Ecarteurs		180		
<b>PAR-TYPE</b> , Ciseaux nasaux		54		
<b>PARTSCH</b> , Ostéotomes - Scalpel		227, 228		
<b>PAPAVERO-HARTMANN</b> , Rhinologie		201		
<b>PAUL</b> , Ecarteurs		176		
<b>PEAN</b> , Pincés hemostáticas		121, 124		
- Pincés hemostáticas délicate		118		
<b>PEAN-MURPHY</b> , Pincés hemostáticas		114		
<b>PECK-JOSEPH</b> , Ciseaux chirurgiques		53		
<b>PEET</b> , Pincés hemostáticas délicate		111		
<b>PENFIELD</b> , Ecarteurs		208		
<b>PENNINGTON</b> , Rugines		211		
<b>Rugines</b>		209 - 219		
<b>PERRY</b> , Pincés chirurgiques		85		
<b>PIERCE</b> , Rugines		211		
<b>Pincés hemostáticas</b>		109 - 130		
<b>Pincés</b>		79 - 106		
<b>PITANGUI</b> , Marcateur		109		
<b>PLESTER</b> , Canules aspiratrices		290		
- Ecarteurs		194		
<b>Porte Aiguilles</b>		133 - 154		
<b>POTTS-SMITH</b> , Pincés chirurgiques		92, 102		
<b>POTTS-YASARGIL</b> , Micro Ciseaux		16		
<b>Q</b>				
<b>QUINBY</b> , Ciseaux délicate		22		
<b>QUINKE</b> , Aiguilles à biopsie		303		
<b>R</b>				
<b>RADOLF</b> , Pincés pour extraire les ongles		280		
<b>RAGNELL</b> , Ecarteurs		180		

- Micro Ciseaux délicate	19
<b>RAGNELL-DAVIS</b> , Ecarteurs	180
<b>RAMPLEY</b> , Pincés à tampons	116
<b>RANKIN</b> , Pincés hémostatiques	123
<b>REYNOLDS</b> , Ciseaux délicate	26
<b>Rhinologie</b>	198 - 201
<b>ROCHESTER-PEAN</b> , Pincés hémostatiques	122, 129
<b>ROGER</b> , Rugines	211
<b>ROGGE</b> , Pincés à stérilisation	315
<b>ROLLET</b> , Micro Ecarteurs	174
<b>ROWE</b> , Pincés à riposition	281
<b>ROSE</b> , Ecarteur	178
<b>ROSTKOWSKI</b> , Ecarteurs	179
<b>ROUX</b> , Ecarteurs	181
<b>ROUX-MAGNUS</b> , Ecarteurs	181
<b>RUBIN</b> , Rhinologie	234, 282
<b>RUSKIN</b> , Rhinologie	273
<b>RUSKIN-LISTON</b> , Pincés à os	275
<b>RUSKIN-STILLE</b> , Pincés à os	273
<b>RYDER</b> , Porte aiguilles	152

## S

<b>SAALFELD</b> , Curettes tranchantes	262
<b>SACHS</b> , Dissecteur - Separateur	206
<b>SALZBURG</b> , Rugines	210
<b>SAROT</b> , Porte aiguilles	149
<b>SAUG-RASPATORIUM</b> , Canules aspiratrices	289
<b>SCHAEDEL</b> , Pincés pour fixer les compresses	112
<b>SCHEDE</b> , Curettes tranchantes	264
<b>SCHNEIDER</b> , Rugines	219
<b>SCHNEIDER-SAUERBRUCH</b> , Rugines à périostomie	242
<b>SCHWACKENDIEK</b> , Ciseaux pour les amygdales	43
<b>SCOVILLE</b> , Ecarteurs	182
<b>SEDILLOT</b> , Rugines	214, 219
<b>SEMKEN</b> , Pincés chirurgiques	87, 92, 101
<b>SENN-GREEN</b> , Ecarteurs	180
<b>SENN-MILLER</b> , Ecarteurs	177
<b>SEWALL</b> , Rugines	212
<b>SHEA</b> , Ciseaux chirurgiques	33
<b>SHEEHAN</b> , Ostéotomes	226
<b>SILVER</b> , Rhinologie	232
<b>SIMON</b> , Ecarteurs	184
<b>SPENCER</b> , Ciseaux à ligatures	74
<b>STACKE</b> , Sondes	160
<b>STEINHÄUSER</b> , Rugines	217
<b>STELLA</b> , Ciseaux chirurgiques	68
<b>STELLBRINK</b> , Pincés à os	269, 271
<b>STEVENS</b> , Ciseaux délicate	19, 26, 48
<b>STILLE</b> , Ciseaux chirurgiques	42
- Pincés anatomiques	90
<b>STITCH</b> , Ciseaux délicate	19
<b>Instruments à mesurer</b>	4 - 5
<b>SWEDESH MOD.</b> , Porte aiguilles	149

## T

<b>TAKAHASHI</b> , Pincés à os	274
<b>TAYLOR</b> , Pincés chirurgiques	102
<b>TENNANT</b> , Pincés chirurgiques	100
<b>TESSIER</b> , Ostéotomes	239, 241
<b>THOREK</b> , Ciseaux chirurgiques	38
<b>TIECK-HALLE</b> , Spéculums nasaux	200
<b>TOBOLD</b> , Abaisse langue	169
<b>TOENNIS</b> , Ciseaux chirurgiques	38
<b>TOENNIS-ADSON</b> , Ciseaux chirurgiques	38, 64
<b>TROELTSH</b> , Pincés auriculaires	105
<b>TUFFIER</b> , Ecarteurs	168
<b>TUOHY</b> , Aiguilles à biopsie	303

## U

<b>UNIVERSAL</b> , Porte-coton	161
<b>UNNA</b> , Curettes tranchantes	262

## V

<b>VANNAS</b> , Micro Ciseaux	15
<b>VARADY</b> , Stripper à anneau	195
<b>VERESS</b> , Aiguilles à biopsie	303
<b>VIDAL</b> , Curettes tranchantes	263
<b>WISE</b> , Micro Pincés	79
<b>VOLKMANN</b> , Curettes tranchantes	262, 265

## W

<b>WALTER</b> , Ostéotomes	231
<b>WALTON</b> , Ciseaux délicate	19, 34
- Rugines	213
<b>WANGESTEEN</b> , Pincés chirurgiques	102
<b>WARWICK-JAMES</b> , Pincés à ongles	306
<b>WEBSTER</b> , Porte aiguilles	145
<b>WEIL-BLAKESLEY</b> , Pincés à os	274
<b>WEITLANER</b> , Ecarteurs	192, 193
<b>WERTHEIMER</b> , Canules aspiratrices	293
<b>WEST</b> , Ostéotomes - Scalpel	228
<b>WESTCOTT</b> , Micro Ciseaux	15
<b>WHITEHEAD-JENNINGS</b> , Ecarteur buccal	165
<b>WIEDER</b> , Abaisse langue	169
<b>WIENER</b> , Micro Ecarteurs	174
<b>WILLIGER</b> , Curettes tranchantes	261, 265
- Elevateur	205
- Maillets chirurgiques	248
<b>WILMER</b> , Ciseaux délicate	22
<b>WULLSTEIN</b> , Ecarteurs	192
- Micro Pincés auriculaires	158

## Y

<b>YANCOSKIE</b> , Ecarteur	190
<b>YANKAUER</b> , Dissecteur	206
- Aiguilles passe-fils	159
<b>YASARGIL</b> , Micro ciseaux	16

## Z

<b>ZAUFAL-JANSEN</b> , Pincés à os	273
------------------------------------	-----



**SADIQ SURGICAL CO.**

Catalogue 2015 / 2016

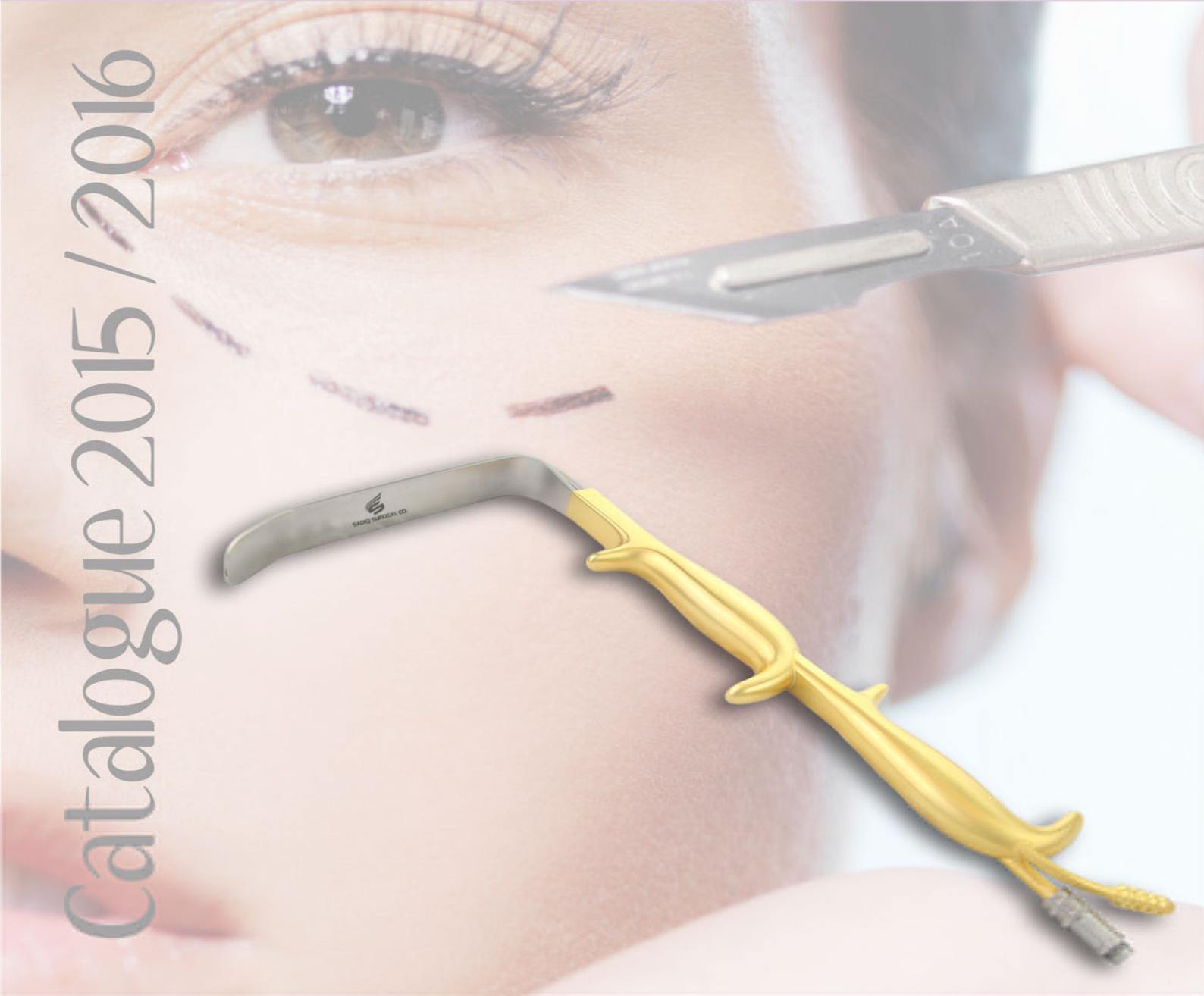

**Plastic Surgery**

14

Nummernverzeichnis  
Alphanumerical index  
Índice alfanumérico  
Índice alfanumérico  
Index alphanumérique





Nummernverzeichnis		Alphanumerical index		Indice alfanumerico		Indice alfanumérico		Index alphanumériques	
Articolo	Pagina	Articolo	Pagina	Articolo	Pagina	Articolo	Pagina	Articolo	Pagina
<b>712-18</b>	212	<b>BD-57</b>	86	<b>BD-124</b>	89	<b>BD-213</b>	101		
		<b>BD-58</b>	86	<b>BD-126</b>	89	<b>BD-214</b>	101		
<b>718-24G</b>	209	<b>BD-59</b>	86	<b>BD-127</b>	91	<b>BD-215</b>	101		
		<b>BD-60</b>	84	<b>BD-128</b>	93	<b>BD-216</b>	101		
<b>AA-S104</b>	3	<b>BD-60T</b>	104	<b>BD-129</b>	93	<b>BD-217</b>	101		
<b>AA-S503</b>	3	<b>BD-61</b>	90	<b>BD-130</b>	99	<b>BD-218</b>	102		
		<b>BD-62</b>	84	<b>BD-131</b>	99	<b>BD-219</b>	102		
<b>AB-04</b>	3	<b>BD-62T</b>	104	<b>BD-132</b>	99	<b>BD-220</b>	102		
<b>AB-05</b>	3	<b>BD-63</b>	90	<b>BD-133</b>	93	<b>BD-221</b>	103		
<b>AB-06</b>	3	<b>BD-64</b>	84	<b>BD-134</b>	93	<b>BD-222</b>	103		
<b>AB-07</b>	3	<b>BD-65</b>	90	<b>BD-135</b>	99	<b>BD-223</b>	103		
<b>AB-09</b>	3	<b>BD-66</b>	84	<b>BD-136</b>	99	<b>BD-224</b>	103		
<b>AB-32R</b>	3	<b>BD-67</b>	90	<b>BD-138</b>	94	<b>BD-225</b>	103		
<b>AB-41R</b>	3	<b>BD-68</b>	84	<b>BD-139</b>	94	<b>BD-226</b>	102		
		<b>BD-70</b>	88	<b>BD-140</b>	99	<b>BD-227</b>	102		
<b>BB-36</b>	9	<b>BD-71</b>	88	<b>BD-141</b>	88	<b>BD-228</b>	102		
<b>BB-46</b>	9	<b>BD-72</b>	88	<b>BD-144</b>	91	<b>BD-229</b>	103		
<b>BB-48</b>	9	<b>BD-73</b>	88	<b>BD-145</b>	87	<b>BD-230</b>	101		
<b>BB-50</b>	9	<b>BD-74</b>	89	<b>BD-146</b>	105	<b>BD-231</b>	101		
<b>BB-52</b>	9	<b>BD-75</b>	89	<b>BD-147</b>	105	<b>BD-232</b>	102		
		<b>BD-75T</b>	104	<b>BD-148</b>	90	<b>BD-233</b>	102		
<b>BD-04</b>	86	<b>BD-76</b>	89	<b>BD-149</b>	94	<b>BD-234</b>	102		
<b>BD-05</b>	85	<b>BD-78</b>	89	<b>BD-160</b>	96	<b>BD-235</b>	79		
<b>BD-06</b>	85	<b>BD-79</b>	89	<b>BD-160T</b>	103	<b>BD-236</b>	79		
<b>BD-07</b>	86	<b>BD-80</b>	96	<b>BD-161</b>	96	<b>BD-237</b>	79		
<b>BD-09</b>	93	<b>BD-80T</b>	103	<b>BD-161T</b>	103	<b>BD-238</b>	86		
<b>BD-09T</b>	104	<b>BD-81</b>	96	<b>BD-162</b>	96	<b>BD-239</b>	86		
<b>BD-10</b>	89	<b>BD-81T</b>	103	<b>BD-162T</b>	103	<b>BD-240</b>	90		
<b>BD-10IS</b>	130	<b>BD-82</b>	96	<b>BD-163</b>	96	<b>BD-241</b>	90		
<b>BD-14</b>	92	<b>BD-83</b>	96	<b>BD-163T</b>	103	<b>BD-242</b>	90		
<b>BD-15</b>	92	<b>BD-84</b>	96	<b>BD-164</b>	96	<b>BD-243</b>	90		
<b>BD-16</b>	90	<b>BD-84T</b>	103	<b>BD-165</b>	97	<b>BD-244</b>	90		
<b>BD-18</b>	93	<b>BD-85</b>	96	<b>BD-166</b>	97	<b>BD-245</b>	90		
<b>BD-19</b>	93	<b>BD-86</b>	96	<b>BD-167</b>	97	<b>BD-246</b>	90		
<b>BD-20</b>	93	<b>BD-86T</b>	103	<b>BD-168</b>	97	<b>BD-247</b>	90		
<b>BD-20IS</b>	130	<b>BD-87</b>	96	<b>BD-169</b>	97	<b>BD-248</b>	90		
<b>BD-21</b>	92	<b>BD-88</b>	96	<b>BD-170</b>	97	<b>BD-249</b>	90		
<b>BD-22</b>	105	<b>BD-89</b>	96	<b>BD-171</b>	97	<b>BD-250</b>	101		
<b>BD-23</b>	89	<b>BD-90</b>	88	<b>BD-172</b>	97	<b>BD-251</b>	101		
<b>BD-23IS</b>	130	<b>BD-91</b>	92	<b>BD-173</b>	97	<b>BD-252</b>	102		
<b>BD-24</b>	89	<b>BD-92</b>	88	<b>BD-174</b>	106	<b>BD-255</b>	100		
<b>BD-24IS</b>	130	<b>BD-93</b>	88	<b>BD-177</b>	88	<b>BD-256</b>	100		
<b>BD-25</b>	89	<b>BD-95</b>	92	<b>BD-178</b>	88	<b>BD-260</b>	99		
<b>BD-26</b>	89	<b>BD-96</b>	86	<b>BD-179</b>	105	<b>BD-261</b>	99		
<b>BD-30</b>	88	<b>BD-97</b>	89	<b>BD-180</b>	93	<b>BD-263</b>	99		
<b>BD-30T</b>	104	<b>BD-98</b>	89	<b>BD-181</b>	93	<b>BD-271</b>	91		
<b>BD-31</b>	88	<b>BD-99</b>	89	<b>BD-182</b>	93	<b>BD-272</b>	91		
<b>BD-31T</b>	104	<b>BD-100</b>	89	<b>BD-183</b>	93	<b>BD-273</b>	91		
<b>BD-32</b>	85	<b>BD-101</b>	105	<b>BD-186</b>	98	<b>BD-273IS</b>	130		
<b>BD-33</b>	85	<b>BD-102</b>	105	<b>BD-190</b>	98	<b>BD-274</b>	91		
<b>BD-34</b>	85	<b>BD-104</b>	93	<b>BD-191</b>	98	<b>BD-275</b>	91		
<b>BD-35</b>	85	<b>BD-105</b>	89	<b>BD-192</b>	98	<b>BD-276</b>	91		
<b>BD-36</b>	85	<b>BD-106</b>	94	<b>BD-193</b>	105	<b>BD-277</b>	91		
<b>BD-38</b>	93	<b>BD-107</b>	94	<b>BD-194</b>	86	<b>BD-277IS</b>	130		
<b>BD-39</b>	93	<b>BD-108</b>	94	<b>BD-194IS</b>	130	<b>BD-278</b>	91		
<b>BD-40</b>	85	<b>BD-109</b>	91	<b>BD-195</b>	86	<b>BD-279</b>	98		
<b>BD-41</b>	85	<b>BD-110</b>	91	<b>BD-196</b>	86	<b>BD-280</b>	98		
<b>BD-42</b>	85	<b>BD-111</b>	91	<b>BD-200</b>	84	<b>BD-281</b>	92		
<b>BD-42T</b>	104	<b>BD-112</b>	91	<b>BD-201</b>	84	<b>BD-282</b>	92		
<b>BD-43</b>	85	<b>BD-113</b>	91	<b>BD-202</b>	84	<b>BD-287</b>	92		
<b>BD-43T</b>	104	<b>BD-114</b>	91	<b>BD-203</b>	84	<b>BD-288</b>	92		
<b>BD-44</b>	87	<b>BD-115</b>	94	<b>BD-205</b>	84	<b>BD-289</b>	92		
<b>BD-45</b>	87	<b>BD-116</b>	94	<b>BD-206</b>	84	<b>BD-290</b>	92		
<b>BD-46</b>	87	<b>BD-117</b>	94	<b>BD-207</b>	87	<b>BD-291</b>	92		
<b>BD-47</b>	87	<b>BD-118</b>	94	<b>BD-208</b>	87	<b>BD-292</b>	92		
<b>BD-51</b>	87	<b>BD-119</b>	94	<b>BD-209</b>	87	<b>BD-300</b>	101		
<b>BD-53</b>	92	<b>BD-120</b>	106	<b>BD-210</b>	101	<b>BD-333</b>	99		
<b>BD-54</b>	92	<b>BD-122</b>	106	<b>BD-211</b>	101	<b>BD-334</b>	99		
<b>BD-56</b>	86	<b>BD-123</b>	106	<b>BD-212</b>	101	<b>BD-342</b>	172		

Nummernverzeichnis		Alphanumerical index		Indice alfanumerico		Indice alfanumérico		Index alphanumériques	
Articolo	Pagina	Articolo	Pagina	Articolo	Pagina	Articolo	Pagina	Articolo	Pagina
<b>BD-343</b>	172	<b>BS-28</b>	312	<b>BT-160</b>	184	<b>BT-401</b>	181		
		<b>BS-30</b>	312	<b>BT-162</b>	184	<b>BT-402</b>	181		
<b>BF-01</b>	116	<b>BS-40</b>	312	<b>BT-163</b>	184	<b>BT-403</b>	181		
<b>BF-02</b>	116	<b>BS-41</b>	312	<b>BT-167</b>	184	<b>BT-404</b>	181		
<b>BF-05</b>	116	<b>BS-42</b>	312	<b>BT-190</b>	177	<b>BT-405</b>	181		
<b>BF-06</b>	116	<b>BS-43</b>	313	<b>BT-191</b>	177	<b>BT-406</b>	181		
<b>BF-07</b>	116	<b>BS-59</b>	313	<b>BT-192</b>	177	<b>BT-490</b>	130		
<b>BF-08</b>	116	<b>BS-60</b>	313	<b>BT-193</b>	177	<b>BT-491</b>	130		
<b>BF-11</b>	115	<b>BS-61</b>	313	<b>BT-194</b>	177	<b>BT-492</b>	130		
<b>BF-13</b>	115			<b>BT-195</b>	177	<b>BT-493</b>	130		
<b>BF-14</b>	115	<b>BT-05</b>	218	<b>BT-196</b>	172	<b>BT-500</b>	186		
<b>BF-15</b>	115	<b>BT-06</b>	218	<b>BT-197</b>	172	<b>BT-501</b>	186		
<b>BF-20</b>	114	<b>BT-07</b>	218	<b>BT-198</b>	172	<b>BT-501R</b>	186		
<b>BF-24</b>	114	<b>BT-09</b>	179	<b>BT-199</b>	172	<b>BT-502</b>	186		
<b>BF-26</b>	114	<b>BT-15</b>	173	<b>BT-200</b>	175	<b>BT-502R</b>	186		
<b>BF-30</b>	116	<b>BT-16</b>	173	<b>BT-203</b>	173	<b>BT-503</b>	187		
<b>BF-31</b>	116	<b>BT-18</b>	177	<b>BT-204</b>	173	<b>BT-503R</b>	187		
<b>BF-38</b>	112	<b>BT-19</b>	177	<b>BT-207</b>	173	<b>BT-504</b>	187		
<b>BF-40</b>	112	<b>BT-20</b>	180	<b>BT-208</b>	173	<b>BT-504R</b>	187		
<b>BF-41</b>	112	<b>BT-22</b>	172	<b>BT-210</b>	175				
<b>BF-42</b>	112	<b>BT-25</b>	180	<b>BT-211</b>	175	<b>BV-07</b>	192		
<b>BF-43</b>	112	<b>BT-26</b>	180	<b>BT-212</b>	175	<b>BV-08</b>	191		
<b>BF-44</b>	112	<b>BT-27</b>	180	<b>BT-213</b>	175	<b>BV-09</b>	192		
<b>BF-45</b>	112	<b>BT-28</b>	179	<b>BT-214</b>	175	<b>BV-10</b>	191		
<b>BF-46</b>	112	<b>BT-37</b>	214	<b>BT-215</b>	175	<b>BV-12</b>	191		
<b>BF-48</b>	112	<b>BT-38</b>	177	<b>BT-216</b>	175	<b>BV-20</b>	193		
<b>BF-50</b>	113	<b>BT-39</b>	177	<b>BT-217</b>	175	<b>BV-21</b>	193		
<b>BF-52</b>	113	<b>BT-40</b>	177	<b>BT-218</b>	175	<b>BV-22</b>	193		
<b>BF-58</b>	114	<b>BT-41</b>	177	<b>BT-218</b>	175	<b>BV-22</b>	193		
<b>BF-74</b>	113	<b>BT-42</b>	177	<b>BT-226</b>	172	<b>BV-23</b>	193		
<b>BF-75</b>	113	<b>BT-44</b>	177	<b>BT-228</b>	184	<b>BV-36</b>	191		
<b>BF-76</b>	113	<b>BT-44</b>	177	<b>BT-229</b>	184	<b>BV-37</b>	191		
<b>BF-76</b>	113	<b>BT-45</b>	177	<b>BT-230</b>	174	<b>BV-38</b>	191		
<b>BF-77</b>	113	<b>BT-46</b>	177	<b>BT-231</b>	174	<b>BV-39</b>	191		
<b>BF-78</b>	115	<b>BT-48</b>	180	<b>BT-232</b>	174	<b>BV-45</b>	191		
<b>BF-79</b>	115	<b>BT-49</b>	180	<b>BT-232</b>	174	<b>BV-47</b>	191		
<b>BF-94</b>	115	<b>BT-50</b>	176	<b>BT-233</b>	174	<b>BV-48</b>	191		
<b>BF-95</b>	115	<b>BT-51</b>	176	<b>BT-234</b>	174	<b>BV-48</b>	191		
		<b>BT-52</b>	176	<b>BT-235</b>	174	<b>BV-49</b>	191		
<b>BM-01</b>	149	<b>BT-54</b>	176	<b>BT-236</b>	174	<b>BV-51</b>	191		
<b>BM-02</b>	149	<b>BT-54</b>	176	<b>BT-237</b>	174	<b>BV-68</b>	193		
<b>BM-03</b>	149	<b>BT-55</b>	176	<b>BT-237</b>	174	<b>BV-70</b>	193		
<b>BM-04</b>	149	<b>BT-56</b>	176	<b>BT-238</b>	176	<b>BV-70</b>	193		
<b>BM-28</b>	159	<b>BT-57</b>	175	<b>BT-239</b>	176	<b>BV-90</b>	194		
<b>BM-61</b>	143	<b>BT-70</b>	179	<b>BT-240</b>	176	<b>BV-91</b>	194		
<b>BM-62</b>	143	<b>BT-71</b>	179	<b>BT-241</b>	176	<b>BV-92</b>	194		
<b>BM-63</b>	143	<b>BT-72</b>	179	<b>BT-242</b>	176	<b>BV-93</b>	194		
<b>BM-63</b>	143	<b>BT-73</b>	179	<b>BT-243</b>	175	<b>BV-111</b>	192		
<b>BM-64</b>	143	<b>BT-74</b>	179	<b>BT-244</b>	179	<b>BV-112</b>	192		
<b>BM-74</b>	159	<b>BT-74</b>	179	<b>BT-245</b>	179				
<b>BM-87</b>	155	<b>BT-75</b>	179	<b>BT-273</b>	172	<b>CH-11</b>	216		
<b>BM-88</b>	155	<b>BT-76</b>	179	<b>BT-282</b>	181	<b>CH-12</b>	216		
<b>BM-89</b>	155	<b>BT-77</b>	179	<b>BT-283</b>	181	<b>CH-13</b>	216		
<b>BM-90</b>	155	<b>BT-79</b>	179	<b>BT-284</b>	181	<b>CH-14</b>	216		
<b>BM-90</b>	155	<b>BT-92</b>	183	<b>BT-285</b>	181				
<b>BM-96</b>	155	<b>BT-93</b>	183	<b>BT-286</b>	181	<b>CS-01</b>	311		
<b>BM-97</b>	155	<b>BT-94</b>	183	<b>BT-287</b>	181	<b>CS-02</b>	311		
<b>BM-98</b>	155	<b>BT-95</b>	183	<b>BT-288</b>	181	<b>CS-03</b>	311		
<b>BM-99</b>	155	<b>BT-96</b>	183	<b>BT-289</b>	181	<b>CS-04</b>	311		
<b>BM-100</b>	155	<b>BT-100</b>	183	<b>BT-291</b>	180	<b>CS-05</b>	311		
<b>BM-101</b>	155	<b>BT-113</b>	182	<b>BT-296</b>	178	<b>CS-06</b>	311		
<b>BM-140</b>	155	<b>BT-114</b>	182	<b>BT-297</b>	178	<b>CS-32</b>	313		
<b>BM-141</b>	155	<b>BT-115</b>	182	<b>BT-298</b>	178	<b>CS-33</b>	313		
<b>BM-142</b>	155	<b>BT-116</b>	182	<b>BT-299</b>	178	<b>CS-34</b>	313		
<b>BM-151</b>	159	<b>BT-117</b>	182	<b>BT-312</b>	182	<b>CS-51</b>	311		
		<b>BT-118</b>	182	<b>BT-341</b>	185	<b>CS-52</b>	311		
<b>BR-20</b>	311	<b>BT-152</b>	183	<b>BT-342</b>	185	<b>CS-55</b>	311		
<b>BR-25</b>	311	<b>BT-153</b>	183	<b>BT-381</b>	170	<b>CS-80</b>	311		
<b>BR-28</b>	311	<b>BT-154</b>	183	<b>BT-382</b>	177	<b>CS-81</b>	311		
		<b>BT-155</b>	183	<b>BT-383</b>	177	<b>CS-82</b>	311		
<b>BS-23</b>	312	<b>BT-156</b>	183	<b>BT-387</b>	170	<b>CS-83</b>	311		
<b>BS-27</b>	312	<b>BT-157</b>	183	<b>BT-388</b>	170				

Nummernverzeichnis		Alphanumerical index		Indice alfanumerico		Indice alfanumérico		Index alphanumériques	
Articolo	Pagina	Articolo	Pagina	Articolo	Pagina	Articolo	Pagina	Articolo	Pagina
<b>DA-07</b>	86	<b>DO-74</b>	258	<b>DO-178</b>	257	<b>DS-33</b>	263		
		<b>DO-75</b>	257	<b>DO-179</b>	259			<b>ES-01</b>	302
<b>DB-1L</b>	309	<b>DO-76</b>	257	<b>DO-180</b>	235	<b>ES-03</b>	302		
<b>DB-4</b>	310	<b>DO-79</b>	259	<b>DO-181</b>	235	<b>ES-05</b>	296		
<b>DB-6A</b>	310	<b>DO-80</b>	259	<b>DO-182</b>	235	<b>ES-06</b>	296		
<b>DB-22A</b>	310	<b>DO-81</b>	259	<b>DO-183</b>	235	<b>ES-07</b>	296		
<b>DB-50M</b>	309	<b>DO-82</b>	259	<b>DO-184</b>	235	<b>ES-08</b>	296		
<b>DB-86</b>	158	<b>DO-83</b>	259	<b>DO-185</b>	235	<b>ES-09</b>	296		
<b>DB-91</b>	158	<b>DO-84</b>	234	<b>DO-189</b>	258	<b>ES-14</b>	266		
<b>DB-93</b>	158	<b>DO-85</b>	234	<b>DO-190</b>	240	<b>ES-15</b>	266		
<b>DB-96</b>	310	<b>DO-87</b>	258	<b>DO-191</b>	240	<b>ES-16</b>	266		
<b>DB-101</b>	274	<b>DO-91</b>	225	<b>DO-192</b>	240	<b>ES-17</b>	266		
<b>DB-102</b>	274	<b>DO-92</b>	225	<b>DO-193</b>	240	<b>ES-18</b>	266		
<b>DB-106</b>	158	<b>DO-94</b>	171	<b>DO-194</b>	240	<b>ES-19</b>	266		
<b>DB-205</b>	158	<b>DO-95</b>	171	<b>DO-195</b>	240	<b>ES-34</b>	296		
<b>DB-215</b>	158	<b>DO-96</b>	171	<b>DO-196</b>	240	<b>ES-35</b>	296		
<b>DB-299</b>	310	<b>DO-97</b>	171	<b>DO-197</b>	240	<b>ES-36</b>	296		
<b>DB-OL</b>	310	<b>DO-101</b>	217	<b>DO-200</b>	197	<b>ES-39</b>	301		
<b>DB-OLR</b>	309	<b>DO-102</b>	217	<b>DO-211</b>	212	<b>ES-41</b>	297		
		<b>DO-103</b>	217	<b>DO-213</b>	178	<b>ES-45</b>	106		
<b>DL-20</b>	306	<b>DO-106</b>	217	<b>DO-214</b>	178	<b>ES-46</b>	106		
		<b>DO-107</b>	217	<b>DO-215</b>	178	<b>ES-48</b>	106		
<b>DEAN</b>	45	<b>DO-109</b>	258	<b>DO-216</b>	232	<b>ES-49</b>	301		
		<b>DO-111</b>	210	<b>DO-217</b>	232	<b>ES-50</b>	301		
<b>DO-1</b>	253	<b>DO-118</b>	234	<b>DO-218</b>	232	<b>ES-51</b>	297		
<b>DO-2</b>	253	<b>DO-119</b>	234	<b>DO-225</b>	236	<b>ES-52</b>	297		
<b>DO-3</b>	253	<b>DO-125</b>	214	<b>DO-226</b>	236	<b>ES-53</b>	297		
<b>DO-4</b>	253	<b>DO-126</b>	214	<b>DO-227</b>	236	<b>ES-54</b>	297		
<b>DO-5</b>	253	<b>DO-130</b>	230	<b>DO-240</b>	210	<b>ES-55</b>	297		
<b>DO-08</b>	169	<b>DO-131</b>	230	<b>DO-241</b>	210	<b>ES-56</b>	297		
<b>DO-09</b>	169	<b>DO-132</b>	230	<b>DO-244</b>	210	<b>ES-57</b>	297		
<b>DO-10</b>	281	<b>DO-133</b>	230	<b>DO-245</b>	256	<b>ES-58</b>	297		
<b>DO-11</b>	281	<b>DO-138</b>	217	<b>DO-246</b>	256	<b>ES-59</b>	297		
<b>DO-12</b>	281	<b>DO-139</b>	217	<b>DO-259</b>	172	<b>ES-60</b>	298		
<b>DO-13</b>	281	<b>DO-140</b>	230	<b>DO-264</b>	172	<b>ES-61</b>	298		
<b>DO-14</b>	281	<b>DO-141</b>	230	<b>DO-288</b>	283	<b>ES-62</b>	298		
<b>DO-15</b>	281	<b>DO-142</b>	170	<b>DO-289</b>	283	<b>ES-63</b>	299		
<b>DO-20</b>	233	<b>DO-143</b>	230	<b>DO-292</b>	213	<b>ES-64</b>	106		
<b>DO-21</b>	233	<b>DO-144</b>	225	<b>DO-293</b>	213	<b>ES-65</b>	106		
<b>DO-22</b>	233	<b>DO-145</b>	225	<b>DO-294</b>	213	<b>ES-66</b>	299		
<b>DO-23</b>	233	<b>DO-146</b>	225	<b>DO-295</b>	213	<b>ES-67</b>	299		
<b>DO-24</b>	233	<b>DO-147</b>	282	<b>DO-296</b>	213	<b>ES-68</b>	298		
<b>DO-25</b>	233	<b>DO-148</b>	282	<b>DO-301</b>	260	<b>ES-69</b>	298		
<b>DO-26</b>	233	<b>DO-149</b>	282	<b>DO-302</b>	260	<b>ES-70</b>	298		
<b>DO-27</b>	233	<b>DO-150</b>	236	<b>DO-303</b>	260	<b>ES-71</b>	298		
<b>DO-30</b>	159	<b>DO-151</b>	237	<b>DO-304</b>	260	<b>ES-72</b>	300		
<b>DO-31</b>	159	<b>DO-152</b>	237	<b>DO-305</b>	260	<b>ES-73</b>	300		
<b>DO-34</b>	232	<b>DO-153</b>	237	<b>DO-312</b>	260	<b>ES-74</b>	300		
<b>DO-35</b>	232	<b>DO-154</b>	237	<b>DO-315</b>	260	<b>ES-75</b>	300		
<b>DO-36</b>	232	<b>DO-155</b>	237	<b>DO-401</b>	197	<b>ES-76</b>	299		
<b>DO-40</b>	170	<b>DO-156</b>	237			<b>ES-77</b>	298		
<b>DO-41</b>	170	<b>DO-157</b>	282	<b>DP-09</b>	280, 306	<b>ES-78</b>	300		
<b>DO-47</b>	210	<b>DO-158</b>	236	<b>DP-90</b>	278	<b>ES-79</b>	299		
<b>DO-48</b>	197	<b>DO-159</b>	233	<b>DP-120</b>	278	<b>ES-80</b>	300		
<b>DO-50</b>	238	<b>DO-160</b>	231			<b>ES-81</b>	299		
<b>DO-51</b>	238	<b>DO-161</b>	231	<b>DR-40</b>	111	<b>ES-82</b>	298		
<b>DO-52</b>	238	<b>DO-162</b>	231			<b>ES-83</b>	299		
<b>DO-53</b>	238	<b>DO-163</b>	231	<b>DS-15</b>	178	<b>ES-84</b>	299		
<b>DO-54</b>	238	<b>DO-164</b>	231	<b>DS-16</b>	178	<b>ES-85</b>	299		
<b>DO-55</b>	238	<b>DO-165</b>	231	<b>DS-19</b>	178	<b>ES-92</b>	301		
<b>DO-59</b>	215	<b>DO-166</b>	231	<b>DS-20</b>	178	<b>ES-102</b>	301		
<b>DO-60</b>	210	<b>DO-167</b>	231	<b>DS-25</b>	263	<b>ES-111</b>	302		
<b>DO-63</b>	215	<b>DO-168</b>	255	<b>DS-26</b>	262	<b>ES-112</b>	302		
<b>DO-65</b>	215	<b>DO-169</b>	255	<b>DS-27</b>	262	<b>ES-120</b>	190		
<b>DO-67</b>	215	<b>DO-170</b>	234	<b>DS-28</b>	262	<b>ES-121</b>	190		
<b>DO-70</b>	257	<b>DO-171</b>	234	<b>DS-29</b>	262	<b>ES-122</b>	190		
<b>DO-71</b>	257	<b>DO-172</b>	234	<b>DS-30</b>	263	<b>ES-123</b>	190		
<b>DO-72</b>	258	<b>DO-173</b>	232	<b>DS-31</b>	263	<b>ES-124</b>	190		
<b>DO-73</b>	258	<b>DO-177</b>	259	<b>DS-32</b>	263				

Nummernverzeichnis		Alphanumerical index		Indice alfanumerico		Indice alfanumérico		Index alphanumériques	
Articolo	Pagina	Articolo	Pagina	Articolo	Pagina	Articolo	Pagina	Articolo	Pagina
ES-125	190	FD-105	134	FE-30	156	FG-41	45		
ES-126	190	FD-106	134	FE-31	156	FG-43	34		
ES-127	190	FD-107	134	FE-32	156	FG-44	34		
ES-128	190	FD-108	134	FE-33	156	FG-45	38		
ES-131	188	FD-113	134	FE-34	156	FG-46	38		
ES-132	188	FD-114	134	FE-35	156	FG-47	32		
ES-133	188	FD-115	134	FE-36	156	FG-48	32		
ES-134	188	FD-116	134	FE-37	156	FG-49	32		
ES-135	188	FD-117	106	FE-38	156	FG-50	26		
ES-140	189	FD-128	138	FE-39	156	FG-51	26		
ES-141	189	FD-137	16	FE-40	156	FG-52	26		
ES-142	189	FD-138	16	FE-41	156	FG-53	26		
ES-143	188	FD-148	139	FE-42	156	FG-54	26		
ES-145	188	FD-149	139	FE-43	156	FG-55	26		
ES-150	195	FD-152	136	FE-44	156	FG-56	26		
ES-151	195	FD-153	136	FE-45	156	FG-57	26		
ES-152	195	FD-172	140	FE-46	156	FG-58	23		
ES-153	195	FD-173	140	FE-47	156	FG-59	23		
ES-200	109	FD-186	16	FE-48	156	FG-60	38		
ES-201	109	FD-187	16	FE-49	156	FG-61	38		
ES-202	109	FD-191	16	FE-50	156	FG-63	64		
		FD-201	81	FE-51	156	FG-64	64		
FB-107	195	FD-202	81	FE-52	156	FG-65	38		
FB-108	195	FD-203	81, 133	FE-53	156	FG-66	27		
FB-109	195	FD-204	81, 133	FE-54	156	FG-67	27		
FB-120	111	FD-211	133	FE-55	156	FG-68	27		
FB-390	196	FD-213	133	FE-56	156	FG-69	27		
FB-392	196	FD-218	139	FE-57	156	FG-73	38		
FB-394	196	FD-219	139	FE-58	156	FG-74	38		
FB-395	196	FD-221	17	FE-59	156	FG-75	38		
FB-396	196	FD-223	17	FE-60	156	FG-90	33		
FB-397	196	FD-246	135			FG-91	33		
FB-398	196	FD-247	135	FF-70	274	FG-92	53		
FB-400	196	FD-248	135			FG-93	34		
		FD-249	135	FG-1	20	FG-94	22		
FD-06	15	FD-306	17	FG-1SC	50	FG-95	34		
FD-08	15	FD-307	17	FG-1TC	53	FG-98	53		
FD-10	15	FD-310	17	FG-2	20	FG-99	45		
FD-12	15	FD-311	17	FG-2SC	50	FG-100	34		
FD-13	15	FD-500	155	FG-2TC	53	FG-101	21		
FD-14	136	FD-501	155	FG-3	22	FG-102	21		
FD-16	136	FD-502	155	FG-4	20	FG-103	21		
FD-17	136	FD-503	155	FG-5	20	FG-104	20		
FD-18	136	FD-504	155	FG-6C	27	FG-105	21		
FD-19	136	FD-505	155	FG-6R	27	FG-108	22		
FD-20	136	FD-506	155	FG-7	46	FG-109	22		
FD-21	137	FD-507	157	FG-8	46	FG-110	47		
FD-22	137	FD-508	157	FG-9	46	FG-112	24		
FD-23	137	FD-509	157	FG-10	43	FG-113	24		
FD-24	134	FD-510	157	FG-11L	52	FG-116	44		
FD-25	137	FD-511	157	FG-12L	52	FG-117	32		
FD-27	138	FD-512	157	FG-13	20	FG-122	22		
FD-28	137	FD-513	157	FG-14	36	FG-123	23		
FD-29	137	FD-514	157	FG-15	20	FG-124	23		
FD-30	139	FD-515	157	FG-16	32	FG-125	43		
FD-31	140	FD-517	157	FG-17	32	FG-126	43		
FD-32	139	FD-518	157	FG-18	32	FG-127	43		
FD-33	138	FD-519	157	FG-19C	27	FG-128	43		
FD-34	140	FD-520	157	FG-19R	27	FG-135	43		
FD-35	138			FG-21	23	FG-136	43		
FD-36	140	FE-21	156	FG-22	23	FG-146	34		
FD-37	140	FE-22	156	FG-23	21	FG-147	33		
FD-39	138	FE-23	156	FG-24	21	FG-148	33		
FD-45	15	FE-24	156	FG-28	36	FG-151	74		
FD-46	15	FE-25	156	FG-30	22	FG-153	64		
FD-63	135	FE-26	156	FG-36	23	FG-154	64		
FD-79	15	FE-27	156	FG-37	23	FG-156	24		
FD-80	15	FE-28	156	FG-38	22	FG-157	24		
FD-81	15	FE-29	156	FG-39	22	FG-158	24		

Articolo	Pagina	Articolo	Pagina	Articolo	Pagina	Articolo	Pagina
FG-159	24	FK-110	264	FL-23	227	FL-267	229
FG-165	64	FK-111	264	FL-24	227	FL-268	229
FG-166	64	FK-112	264	FL-32	229	FL-269	229
FG-167	53	FK-113	264	FL-40	227	FL-272	245
FG-168	53	FK-114	264	FL-53	229	FL-280	246
FG-182	44	FK-115	264	FL-54	229	FL-281	246
FG-183	44	FK-116	264	FL-58	229	FL-282	246
FG-184	44	FK-120	264	FL-59	244	FL-283	246
FG-185	44	FK-121	264	FL-60	244	FL-307	241
FG-186	44	FK-122	264	FL-61	244	FL-308	241
FG-187	44	FK-123	264	FL-62	244	FL-309	241
FG-200	18	FK-124	264	FL-104	249	FL-310	241
FG-201	18	FK-125	264	FL-105	249	FL-311	241
FG-202	18	FK-126	264	FL-108	249	FL-312	241
FG-203	18	FK-136	263	FL-114	227	FL-334	247
FG-204	18	FK-137	263	FL-115	227	FL-335	247
FG-205	18	FK-138	263	FL-116	227	FL-336	247
FG-206	18	FK-139	263	FL-118	227	FL-337	247
FG-207	18	FK-174	254	FL-126	227	FL-380	226
FG-208	18	FK-175	255	FL-127	227	FL-381	226
FG-209	19	FK-177	262	FL-132	227	FL-382	226
FG-210	19	FK-178	262	FL-133	228	FL-383	226
FG-211	19	FK-193	256	FL-134	228	FL-384	226
FG-212	19	FK-194	256	FL-135	227	FL-385	226
FG-215	19	FK-195	256	FL-136	227	FL-386	226
FG-216	19	FK-196	256	FL-138	227	FL-387	226
FG-217	19	FK-197	265	FL-141	224	FL-388	226
FG-218	19	FK-198	265	FL-142	224	FL-401	239
FG-219	19	FK-230	243	FL-143	224	FL-402	239
		FK-232	243	FL-144	224	FL-403	239
FK-1	28	FK-234	243	FL-150	263	FL-404	239
FK-1TC	54	FK-247	219	FL-151	263	FL-405	239
FK-2	28	FK-248	219	FL-152	263	FL-410	239
FK-2TC	54	FK-249	219	FL-153	263	FL-411	239
FK-10	28	FK-250	219	FL-154	263	FL-412	239
FK-12	209	FK-251	219	FL-155	263		
FK-15	242	FK-252	218	FL-156	263	FM-1	35
FK-16	242	FK-253	219	FL-157	263	FM-1F	35
FK-17	242	FK-254	219	FL-158	263	FM-1SC	50
FK-60	265	FK-255	219	FL-159	263	FM-2	35
FK-61	265	FK-256	219	FL-177	228	FM-2F	35
FK-62	265	FK-257	219	FL-179	228	FM-2SC	50
FK-63	265	FK-258	219	FL-181	228	FM-3	35
FK-64	265	FK-259	242	FL-185	228	FM-3F	35
FK-65	265	FK-260	218	FL-186	228	FM-3SC	50
FK-66	265	FK-261	218	FL-187	228	FM-4	35
FK-67	265	FK-262	218	FL-210	245	FM-4F	35
FK-68	265	FK-263	218	FL-211	245	FM-4SC	50
FK-69	265	FK-264	213	FL-212	245	FM-5	39
FK-70	261	FK-265	213	FL-213	245	FM-5SC	51
FK-71	261			FL-214	245	FM-6	39
FK-72	262	FL-01	248	FL-215	245	FM-6SC	51
FK-73	262	FL-02	248	FL-216	245	FM-7	31
FK-74	262	FL-03	227	FL-220	245	FM-7L	52
FK-75	261	FL-04	227	FL-221	245	FM-8	31
FK-76	261	FL-05	227	FL-222	245	FM-8L	52
FK-77	261	FL-09	248	FL-223	245	FM-9	29
FK-78	261	FL-09R	248	FL-224	245	FM-9L	52
FK-79	262	FL-10M	248	FL-225	245	FM-10	29
FK-80	218	FL-11	248	FL-226	245	FM-10L	52
FK-82	212, 218	FL-11R	248	FL-230	244	FM-11	37
FK-83	261	FL-12	248	FL-231	244	FM-12	33
FK-84	261	FL-12R	248	FL-232	244	FM-13	37
FK-87	28	FL-13	227	FL-233	244	FM-24	39
FK-88	28	FL-14	227	FL-234	244	FM-24SC	51
FK-96	254	FL-15	227	FL-263	229	FM-25	39
FK-97	254	FL-16	229	FL-264	229	FM-25SC	51
FK-98	254	FL-17	229	FL-265	229	FM-27	30
FK-99	254	FL-18	229	FL-266	229	FM-28	30

Nummernverzeichnis		Alphanumerical index		Indice alfanumerico		Indice alfanumérico		Index alphanumériques	
Articolo	Pagina	Articolo	Pagina	Articolo	Pagina	Articolo	Pagina	Articolo	Pagina
FM-29	30	FM-98	61	FM-300	48	FO-146	275		
FM-29L	52	FM-99	61	FM-301	48	FO-156	273		
FM-29SC	51	FM-100	65	FM-305	70	FO-157	273		
FM-30	30	FM-102	65	FM-306	71	FO-159	280		
FM-30L	52	FM-104	65	FM-307	71	FO-180	274		
FM-30SC	51	FM-109	33	FM-310	71	FO-190	47		
FM-31	30	FM-110	42	FM-311	66	FO-218	276		
FM-32	30	FM-111	42	FM-312	67	FO-219	276		
FM-33	30	FM-112	37	FM-316	54	FO-220	269		
FM-34	30	FM-113	37	FM-317	54	FO-299	280		
FM-35	29	FM-114	37	FM-320	68	FO-300	280		
FM-36	29	FM-115	37	FM-321	68	FO-490	283		
FM-37	29	FM-116	37	FM-323	68				
FM-38	29	FM-117	37	FM-324	73	FR-10	205		
FM-39	29	FM-118	54	FM-325	66	FR-11	12		
FM-40	29	FM-119	54	FM-326	66	FR-12	11		
FM-41	31	FM-120	36	FM-328	72	FR-15	209		
FM-42	31	FM-121	36	FM-329	72	FR-18	12		
FM-43	31	FM-122	36	FM-330	71	FR-19	12		
FM-44	31	FM-126	33	FM-331	72	FR-48	11		
FM-45	31	FM-127	33	FM-334	66	FR-49	12		
FM-46	31	FM-130	62	FM-335	67	FR-64	213		
FM-47	34	FM-131	62	FM-336	73	FR-65	213		
FM-48	34	FM-132	62	FM-337	73	FR-66	212		
FM-49	30	FM-133	62	FM-338	67	FR-67	212		
FM-50	55	FM-134	62	FM-339	69	FR-100	216		
FM-51	55	FM-135	62	FM-340	69	FR-166	216		
FM-52	55	FM-136	62	FM-341	68	FR-167	216		
FM-53	55	FM-137	62	FM-342	69	FR-168	12		
FM-54	56	FM-139	63	FM-343	70	FR-169	12		
FM-55	56	FM-140	63	FM-344	70	FR-175	12		
FM-56	56	FM-141	63	FM-350	54	FR-176	11		
FM-57	56	FM-142	63	FM-351	70	FR-177	12		
FM-58	57	FM-143	63						
FM-59	57	FM-145	57	FO-15	270	FREER	209		
FM-60	57	FM-146	57	FO-16	271				
FM-61	57	FM-147	57	FO-17	270	GF-20	288		
FM-62	30	FM-148	55	FO-18	272	GF-40	303		
FM-63	30	FM-149	55	FO-19	270	GF-41	293		
FM-66	58	FM-150	55	FO-20	273	GF-42	293		
FM-67	58	FM-151	56	FO-21	270	GF-43	291		
FM-68	58	FM-152	56	FO-22	269	GF-45	291		
FM-69	58	FM-153	56	FO-23	269	GF-47	291		
FM-70	36	FM-160	58	FO-24	269	GF-48	289		
FM-71	36	FM-161	58	FO-25	271	GF-49	289		
FM-72	31	FM-162	58	FO-34	273	GF-50	289		
FM-73	31	FM-163	58	FO-35	273	GF-53	292		
FM-74	36	FM-180	41	FO-37	272	GF-55	292		
FM-75	36	FM-181	41	FO-39	272	GF-56	292		
FM-76	42	FM-188	39	FO-43	271	GF-57	292		
FM-77	42	FM-189	39	FO-45	272	GF-58	292		
FM-78	42	FM-201	59	FO-47	276	GF-59	292		
FM-79	42	FM-202	60	FO-58	275	GF-60	293		
FM-80	40	FM-203	59	FO-59	275	GF-61	293		
FM-81	40	FM-204	60	FO-60	275	GF-63	291		
FM-82	40	FM-205	59	FO-61	275	GF-65	291		
FM-83	40	FM-206	60	FO-63	47	GF-67	291		
FM-84	40	FM-207	59	FO-87	271	GF-69	293		
FM-85	40	FM-208	60	FO-88	269	GF-70	293		
FM-86	41	FM-209	59	FO-89	269	GF-71	289		
FM-87	41	FM-210	60	FO-108	275	GF-72	289		
FM-88	41	FM-211	59	FO-130	276	GF-73	289		
FM-89	41	FM-212	60	FO-131	276	GF-74	289		
FM-90	61	FM-294	48	FO-138	273	GF-75	287		
FM-91	61	FM-295	48	FO-139	273	GF-76	287		
FM-92	61	FM-296	48	FO-141	282	GF-77	287		
FM-94	61	FM-297	48	FO-142	282	GF-85	295		
FM-96	53, 61	FM-298	48	FO-143	283	GF-86	295		
FM-97	61	FM-299	48	FO-144	47, 283	GF-87	295		

Nummernverzeichnis		Alphanumerical index		Indice alfanumerico		Indice alfanumérico		Index alphanumériques	
Articolo	Pagina	Articolo	Pagina	Articolo	Pagina	Articolo	Pagina	Articolo	Pagina
GF-88	295	GS-21	304	KO-71	213	MF-102T	104		
GF-89	303	GS-22	306	KO-72	213	MF-103	95		
GF-90	303	GS-23	75			MF-104	95		
GF-92	294	GS-24	75	LB-10	7	MF-105	95		
GF-93	294	GS-25	75	LB-11	7	MF-110	80		
GF-94	294	GS-26	75	LB-12	7	MF-111	80		
GF-96	294	GS-27	75	LB-13	7	MF-112	80		
GF-97	294	GS-28	75	LB-15	7	MF-113	80		
GF-98	288	GS-29	75	LB-20	8	MF-114	80		
GF-99	288	GS-30	316	LB-21	8	MF-115	80		
GF-100	295	GS-32	305	LB-22	8	MF-124	82		
GF-101	295	GS-34	305	LB-23	8	MF-125	82		
GF-102	295	GS-35	305	LB-25	8	MF-126	82		
GF-103	295	GS-36	305	LB-40	10	MF-127	82		
GF-104	288	GS-37	305	LB-361	9	MF-128	82		
GF-110	288	GS-38	305	LB-362	9	MF-129	82		
GF-111	294	GS-40	306	LB-363	9	MF-142T	82		
GF-112	294	GS-41	304	LB-364	9	MF-143T	82		
GF-113	294	GS-42	304	LB-365	9	MF-148	82		
GF-140	290	GS-43	304	LB-366	9	MF-149	82		
GF-141	290	GS-44	304	LB-367	9	MF-150	100		
GF-142	290	GS-45	304	LB-368	9	MF-175	100		
GF-143	290	GS-46	305	LB-369	9	MF-176	100		
GF-144	290	GS-48	305			MF-177	100		
GF-150	290	GS-50	306	LG-1	25	MF-178	100		
GF-151	290			LG-1SC	49	MF-179	100		
GF-152	290	KO-1	205	LG-2SC	49	MF-180	100		
GF-153	290	KO-2	205			MF-181	100		
GF-154	290	KO-11	211	LK-1	24	MF-182	100		
GF-188	303	KO-12	211	LK-2	28	MF-230	100		
GF-200	303	KO-13	211	LK-3	24	MF-235	100		
GF-232	291	KO-14	207	LK-4	28	MF-342T	82		
GF-240	290	KO-15	207			MF-343T	82		
GF-241	290	KO-16	207	LS-04	5	MF-354T	83		
GF-242	290	KO-17	207	LS-06	5	MF-355T	83		
GF-243	290	KO-18	206	LS-07	5	MF-356T	83		
GF-244	290	KO-19	206	LS-08	5	MF-357T	83		
GF-256	295	KO-20	209	LS-09	5	MF-358T	83		
GF-257	295	KO-21	206			MF-359T	83		
		KO-24	206	LX-102	277	MF-362T	83		
GFC	25	KO-25	206	LX-103	277	MF-363T	83		
GFC-S	21	KO-26	206	LX-109	275	MF-364T	83		
GFC-SC	49	KO-27	206	LX-125	278	MF-365T	83		
GFC-TC	53	KO-28	206	LX-138	279				
		KO-29	206	LX-139	279	MO-15	218		
GFR	25	KO-30	211	LX-140	279				
GFR-S	21	KO-38	216	LX-141	279	NK-1	9		
GFR-SC	49	KO-39	209			NK-2	9		
GFR-TC	53	KO-40	208	MA-B1	6	NK-12	10		
		KO-41	208	MA-B2	7	NK-80	174		
GFS	25	KO-42	208	MA-B3	6	NK-82	174		
GFS-SC	49	KO-43	208	MA-B3M	6	NK-83	174		
		KO-44	208	MA-B4	8	NK-84	174		
GS-01	316	KO-46	211	MA-B7	6	NK-86	174		
GS-02	315	KO-47	207	MA-B7K	6	NK-100	11		
GS-03	315	KO-48	207	MA-B8	7	NK-101	11		
GS-04	315	KO-49	207	MA-B9	7	NK-102	11		
GS-05	316	KO-50	207	MA-B10	8	NK-144	179		
GS-06	315	KO-54	206			NK-145	179		
GS-07	316	KO-61	211	MEAD	209	NK-251	180		
GS-09	316	KO-62	211			NK-420	173		
GS-10	315	KO-63	211	MF-04	79	NK-421	173		
GS-11	315	KO-64	211	MF-81	79	NK-422	173		
GS-13	316	KO-65	211	MF-82	79	NK-430	11		
GS-14	316	KO-66	211	MF-93	79	NK-431	11		
GS-16	10	KO-67	212	MF-94	79	NK-432	11		
GS-18	10	KO-68	212	MF-101	95	NK-433	11		
GS-19	306	KO-69	212	MF-101T	104				
GS-20	305	KO-70	213	MF-102	95	OL-01	302		

Nummernverzeichnis		Alphanumerical index		Indice alfanumerico		Indice alfanumérico		Index alphanumériques	
Articolo	Pagina	Articolo	Pagina	Articolo	Pagina	Articolo	Pagina	Articolo	Pagina
OL-02	302	OM-145	166	P-66	126	P-200	126		
OL-03	302	OM-146	166	P-67	126	P-205	126		
OL-04	302	OM-160	165	P-68	118	P-206	126		
OL-05	302	OM-161	165	P-69	118	P-207	111		
OL-41	303	OM-162	165	P-70	125	P-208	126		
OL-42	303	OM-163	165	P-71	125	P-209	126		
OL-43	303	OM-164	165	P-72	125	P-210	129		
OL-44	303	OM-170	166	P-73	125	P-215	129		
OL-45	303	OM-171	166	P-74	125	P-216	129		
OL-46	303	OM-172	166	P-75	125	P-217	129		
OL-47	303	OM-173	166	P-76	125	P-221	122		
OL-48	303	OM-174	166	P-77	125	P-230	120		
OL-49	303			P-79	123	P-231	120		
		OR-11	4	P-81	119	P-232	120		
OM-06	169	OR-13	4	P-82	119	P-233	120		
OM-08	169	OR-15	4	P-84	123	P-234	120		
OM-20	198	OR-17	4	P-85	123	P-235	120		
OM-21	198	OR-19	4	P-86	119	P-236	120		
OM-22	198	OR-40	5	P-87	119	P-237	120		
OM-23	198	OR-45	5	P-89	123	P-238	120		
OM-24	198			P-91	118	P-239	120		
OM-25	201	P-08	114	P-92	118	P-240	120		
OM-26	198	P-09	114	P-93	118	P-241	120		
OM-27	201	P-15	127	P-94	118	P-242	120		
OM-28	201	P-16	119	P-95	117	P-243	120		
OM-29	201	P-17	118	P-96	117	P-244	120		
OM-31	198	P-18	122	P-97	117	P-245	120		
OM-32	199	P-19	122	P-98	117	P-246	123		
OM-34	199	P-20	124	P-100	110	P-247	123		
OM-36	199	P-21	124	P-101	117	P-248	126		
OM-38	199	P-22	124	P-102	117	P-249	126		
OM-39	201	P-23	124	P-115	110	P-250	121		
OM-48	200	P-24	124	P-118	110	P-251	121		
OM-49	200	P-25	124	P-119	110	P-252	121		
OM-51	200	P-26	124	P-120	117	P-253	121		
OM-53	200	P-28	122	P-121	117	P-254	121		
OM-54	200	P-29	122	P-122	119	P-255	121		
OM-56	200	P-30	124	P-132	110	P-256	121		
OM-57	200	P-31	124	P-133	110	P-257	121		
OM-59	200	P-32	124	P-134	110	P-258	121		
OM-74	169	P-33	124	P-135	117	P-259	121		
OM-75	169	P-34	124	P-136	127	P-260	121		
OM-76	169	P-35	124	P-137	127	P-261	121		
OM-77	169	P-36	124	P-138	127	P-262	121		
OM-80	168	P-38	122	P-139	127	P-263	121		
OM-81	168	P-39	122	P-142	128	P-266	111		
OM-82	168	P-40	125	P-143	128	P-267	111		
OM-85	168	P-41	125	P-144	128				
OM-87	168	P-42	125	P-145	128	PF-7	160		
OM-88	168	P-43	125	P-146	128	PF-14	160		
OM-99	168	P-44	125	P-147	128	PF-15	160		
OM-101	168	P-45	125	P-148	128	PF-20	160		
OM-102	168	P-46	125	P-160	128	PF-21	160		
OM-103	168	P-47	125	P-161	128	PF-22	160		
OM-104	168	P-49	123	P-162	128	PF-23	160		
OM-110	167	P-50	110	P-163	128	PF-25	160		
OM-111	167	P-51	110	P-164	128	PF-26	160		
OM-112	167	P-53	110	P-165	128	PF-27	160		
OM-113	167	P-54	123	P-166	128	PF-28	160		
OM-114	167	P-55	123	P-170	127	PF-29	160		
OM-136	165	P-56	122	P-171	127	PF-30	160		
OM-137	165	P-57	122	P-172	127	PF-31	160		
OM-138	165	P-58	122	P-173	127	PF-32	160		
OM-139	165	P-59	122	P-191	129	PF-33	160		
OM-140	166	P-61	119	P-192	129	PF-34	160		
OM-141	166	P-62	119	P-193	129	PF-35	160		
OM-142	166	P-63	119	P-194	129	PF-36	160		
OM-143	166	P-64	119	P-195	129	PF-37	160		
OM-144	166	P-65	126	P-196	129	PF-38	160		



Nummernverzeichnis		Alphanumerical index		Indice alfanumerico		Indice alfanumérico		Index alphanumériques	
Articolo	Pagina	Articolo	Pagina	Articolo	Pagina	Articolo	Pagina	Articolo	Pagina
PF-40	161	PH-112	150						
PF-41	161	PH-113	150	VS-20	311				
PF-43	161	PH-114	150	VS-26	311				
PF-44	160	PH-120	146	VS-30	311				
PF-46	161	PH-121	146						
PF-48	161	PH-122	146	WG-10	205				
PF-49	161	PH-123	146	WG-12	205				
PF-50	161	PH-124	146	WG-14	205				
PF-51	161	PH-125	146						
PF-52	161	PH-127	147						
PF-62	161	PH-128	147						
PF-63	161	PH-129	147						
PF-64	161	PH-130	153						
		PH-132	149						
PH-38	141	PH-133	149						
PH-39	141	PH-134	149						
PH-40	142	PH-140	151						
PH-41	142	PH-141	151						
PH-42	142	PH-142	151						
PH-43	142	PH-143	151						
PH-44	142	PH-144	151						
PH-45	142	PH-145	151						
PH-48	141								
PH-52	142	PO-50	154						
PH-53	145	PO-51	154						
PH-54	147	PO-52	154						
PH-58	153	PO-55	154						
PH-59	146	PO-56	154						
PH-61	141	PO-59	144						
PH-62	141	PO-85	154						
PH-63	141	PO-86	154						
PH-64	141	PO-87	154						
PH-65	145	PO-89	144						
PH-66	145	PO-97	148						
PH-67	145	PO-97L	148						
PH-68	145	PO-99	148						
PH-69	145	PO-99L	148						
PH-70	142	PO-104	144						
PH-71	147	PO-105	144						
PH-72	146								
PH-73	145	SC-1	74						
PH-74	142	SC-2	74						
PH-75	146	SC-5	74						
PH-76	146	SC-9	74						
PH-77	147	SC-12	74						
PH-78	142								
PH-79	147	TG-10	223						
PH-80	152	TG-11	212, 223						
PH-81	152	TG-12	223						
PH-82	152	TG-20	223						
PH-83	152	TG-21	223						
PH-84	152	TG-22	223						
PH-85	147	TG-23	212, 223						
PH-90	147	TG-30	224						
PH-95	146	TG-31	224						
PH-96	146	TG-32	224						
PH-97	146	TG-40	224						
PH-99	153	TG-41	224						
PH-100	153								
PH-101	150	TS-50	294						
PH-102	150	TS-101	314						
PH-103	150	TS-102	314						
PH-104	150	TS-103	314						
PH-106	149	TS-104	314						
PH-107	149								
PH-108	149	VH-20	279						
PH-109	150	VH-21	279						
PH-110	150	VH-23	279						
PH-111	150	VH-40	278						





**SADIQ SURGICAL CO.**

Catalogue 2015 / 2016



**Plastic Surgery**



Wundhaken mit  
Fiberoptikstab

Retractors with  
Fiber optic

Divaricatore con  
fibra ottica

Retractor con  
iluminación de luz fría

Ecarteur avec illumination  
à lumière froide

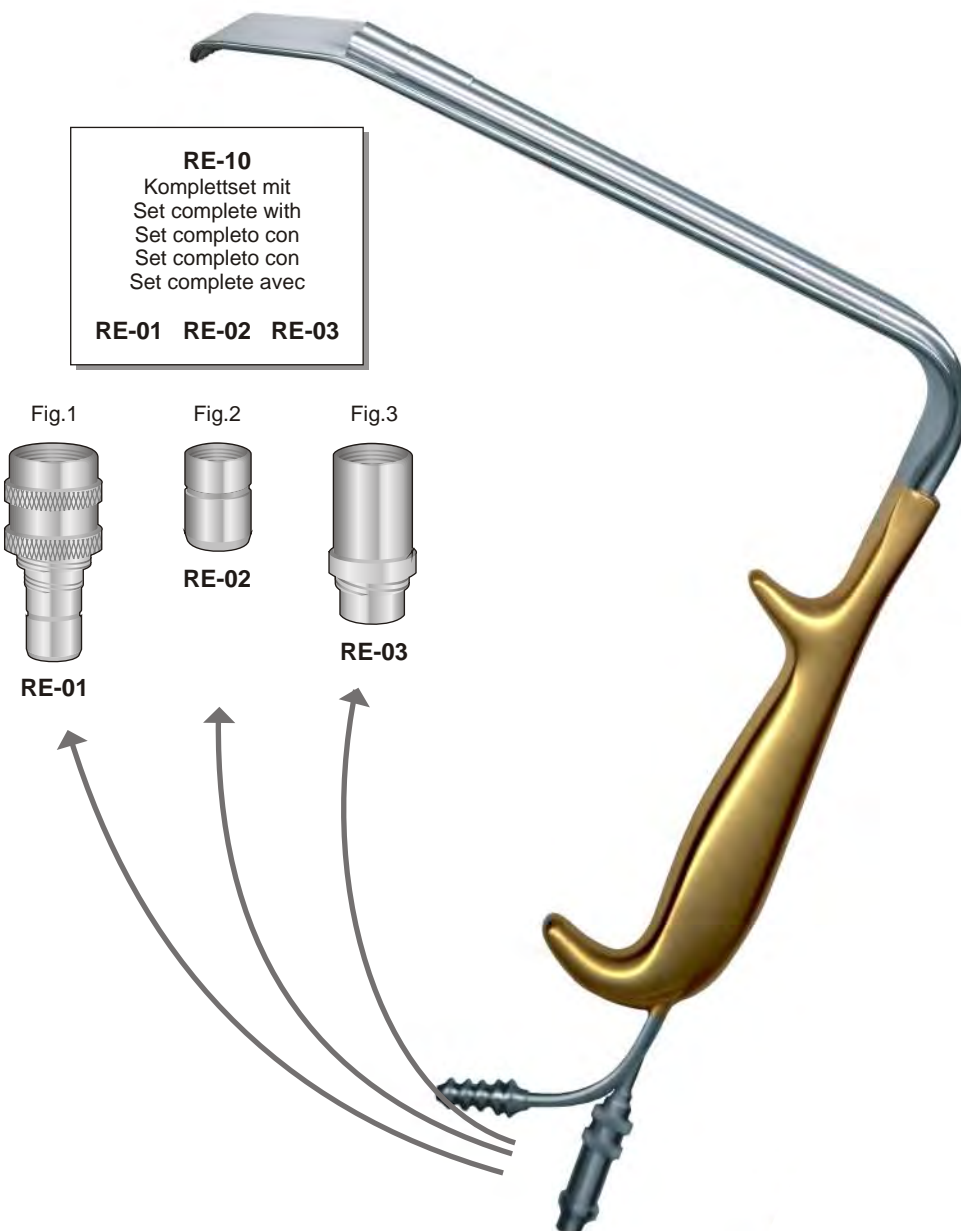

**RE-10**  
Komplettsset mit  
Set complete with  
Set completo con  
Set completo con  
Set complete avec

**RE-01 RE-02 RE-03**

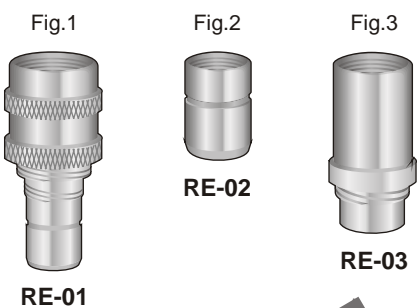

## Fiber Optic Retractor - Divaricatore a fibra ottica

### Advantages - Vantaggi

Sterilizable. Removable. Protected fiber-optic piece  
Oval Shaped optic end for great light field  
Retractor with concave blade for added operative space and visibility  
Equiped with universal adapters WOLF, STORZ, OLYMPUS  
German Stainless Steel, cool Fiber optic light sterilizable till 134°C

Asportabile e sterilizzabile. Fibra ottica protetta su tutto lo strumento per garantire una maggiore stabilità e sicurezza del movimento  
Progettato e realizzato per garantire all'operatore massima maneggevolezza ed alta intensità di luce fredda in tutte quelle situazioni che comportano una visione operatoria a cielo chiuso  
Grazie ai suoi tre attacchi universali WOLF, STORZ e OLYMPUS, facilita l'operatore nel potersi muovere da un ambito ambulatoriale ad uno ospedaliero senza dover rinunciare a un campo visivo indispensabile per la sua professione  
Acciaio tedesco Fiber Optic luce fredda, Sterilizzabile fino a 134°C

Sizes - Misure dei divaricatori:

<b>BT-501</b> 90 x 24 mm	<b>RE-01</b> Fig.1
<b>BT-502</b> 115 x 24 mm	<b>RE-02</b> Fig.2
<b>BT-503</b> 150 x 36 mm	<b>RE-03</b> Fig.3
<b>BT-504</b> 190 x 30 mm	<b>RE-10</b> Set Fig.1 + Fig.2 + Fig.3

Wundhaken mit  
Fiberoptikstab oval

Retractors with  
Fiber optic oval

Divaricatori a  
fibre ottiche ovale

Retractor con  
iluminación de luz fría

Ecarteur avec  
illumination à lumière froide

Wundhaken mit Fiberoptikstab  
Retractors with Fiber optic illumination  
Divaricatori con illuminazione a fibre ottiche  
Retractor con iluminación de luz fría  
Ecarteur avec illumination à lumière froide

Wundhaken - Retractor  
Divaricatore - Separador  
Ecarteur

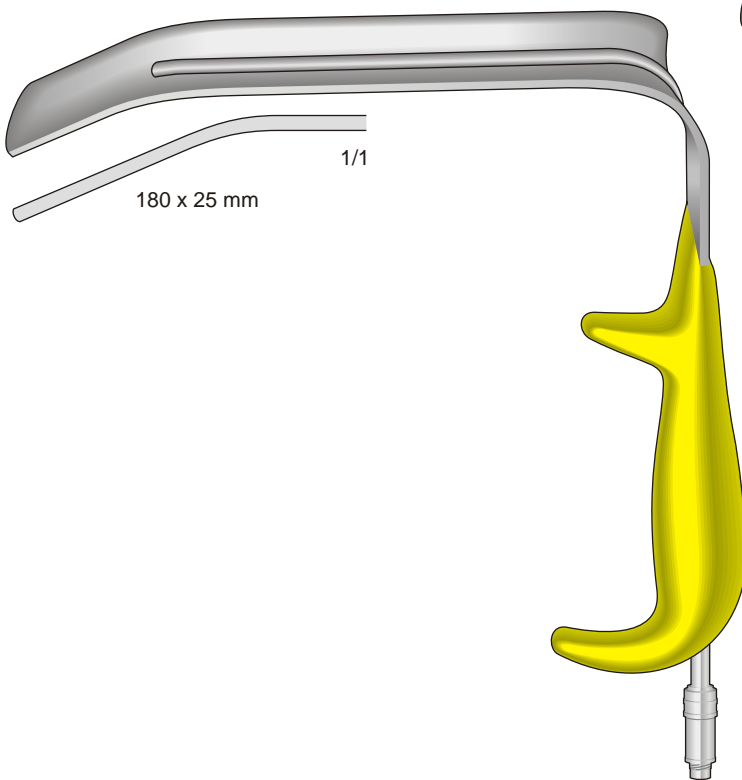

**BT-505**

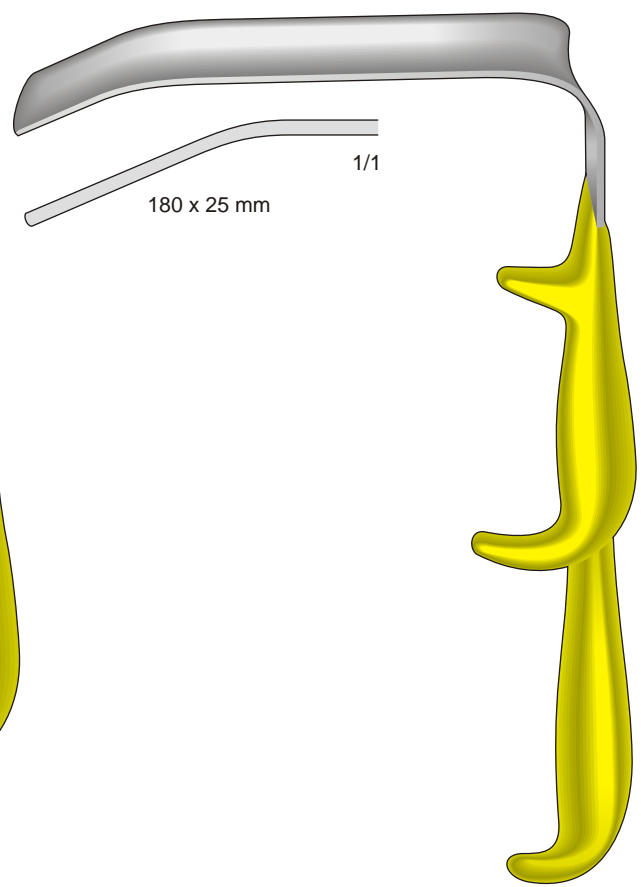

**BT-510**

Dissektoren

Dissectors

Dissettori

Separadores

Dissecteurs

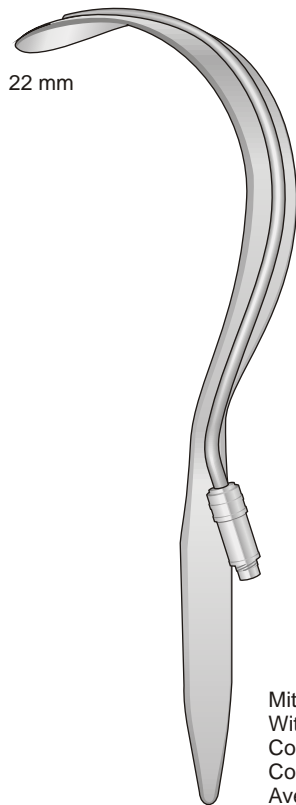

Mit Fiberoptikstab  
With Fiber optic  
Con illuminazione a fibre ottiche  
Con iluminación de luz fría  
Avec illumination à lumière froide

DEAVER  
**BT-511**  
215 mm

Fig. 1 - 5°

10 mm

Fig. 2

7 mm

Fig. 3

Fig. 4

Fig. 5

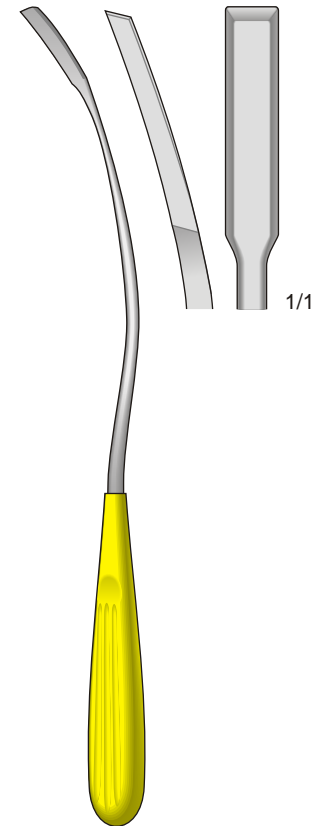
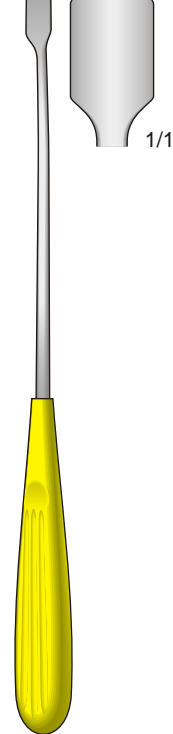
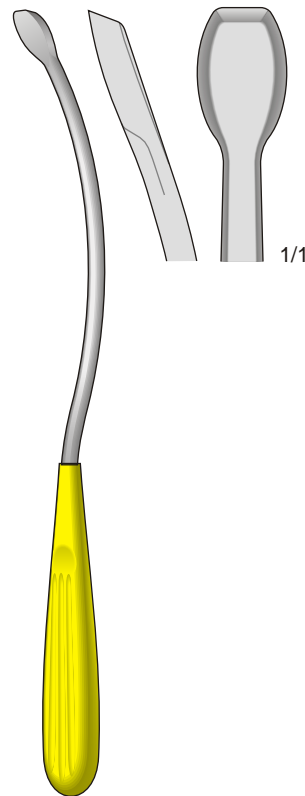
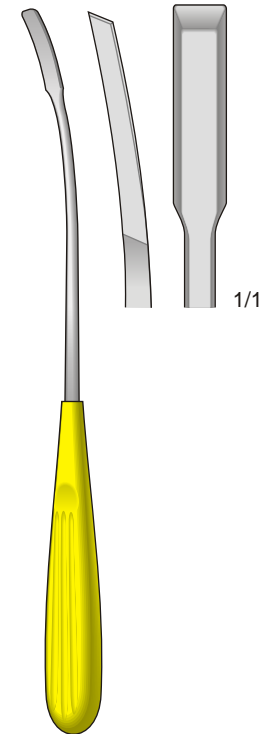
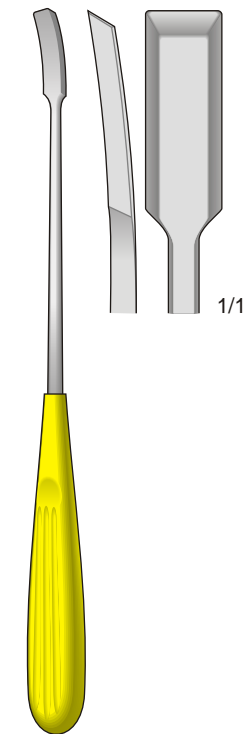

**ES-131**  
240 mm

**ES-132**  
240 mm

**ES-133**  
265 mm

**ES-134**  
250 mm

**ES-135**  
280 mm

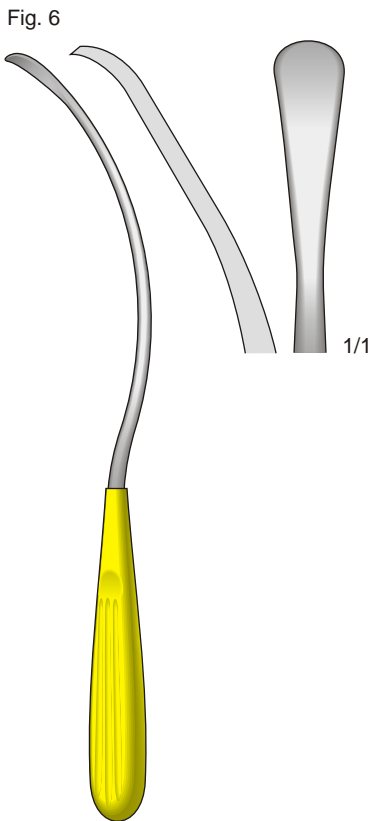

**ES-136**  
255 mm

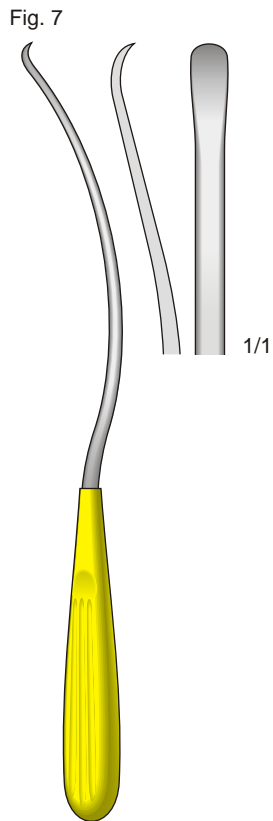

**ES-137**  
260 mm

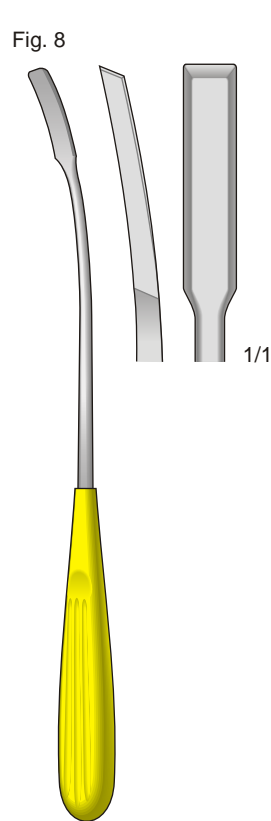

**ES-138**  
250 mm

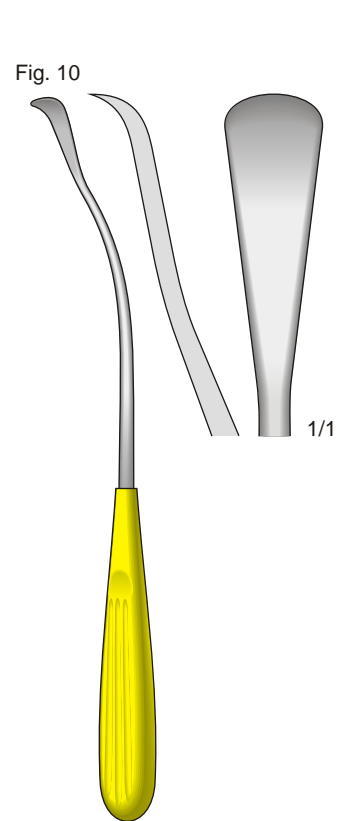

**ES-139**  
230 mm



Dissektoren  
Elevatoren

Dissectors  
Elevators

Dissettori  
Elevatori

Separadores  
Elevadores

Dissecteurs  
Elevateurs

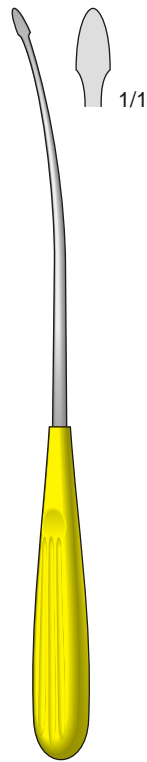

**ES-216**  
235 mm

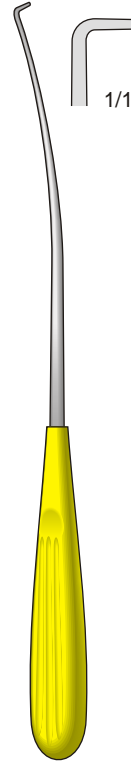

**ES-217**  
235 mm

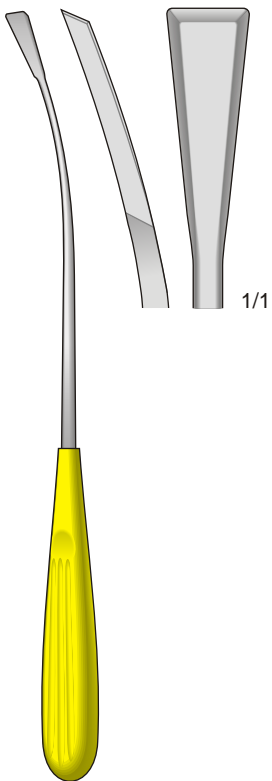

**ES-211**  
240 mm

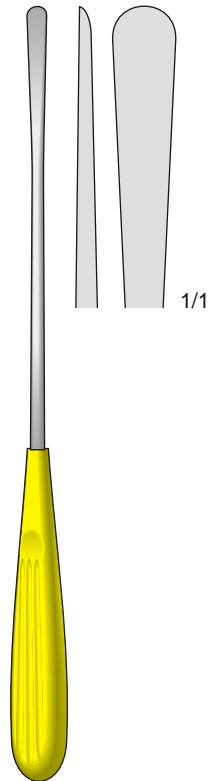

**ES-212**  
240 mm

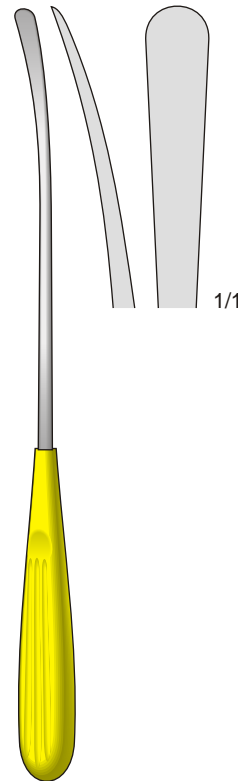

**ES-213**  
240 mm

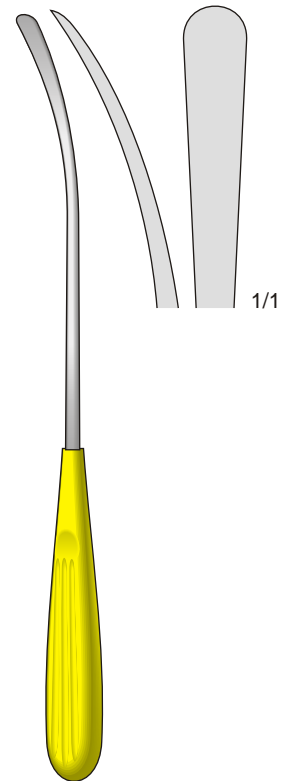

**ES-215**  
240 mm

Rostfrei - Stainless Steel  
Acciaio - Acero  
Acer

Schwarz Verchromt  
Black anodized  
Cromato nero  
Cromado en negro  
Chromé noir

22x14 mm

100 mm

1/1



MENEGHINI  
**OM-230**  
200 mm

Rostfrei - Stainless Steel  
Acciaio - Acero  
Acer

Schwarz Verchromt  
Black anodized  
Cromato nero  
Cromado en negro  
Chromé noir

24x14 mm



MENEGHINI  
**OM-231**  
180 mm

**Dissector  
Wundhaken**

**Dissector  
Retractors**

**Dissettori  
Divaricatori**

**Disecadores  
Separadores**

**Dissecteur  
Ecarteur**

Modello  
Standard

Modello  
Fine

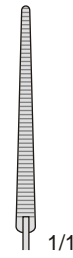

**DB-118**  
200 mm

**DB-119**  
200 mm

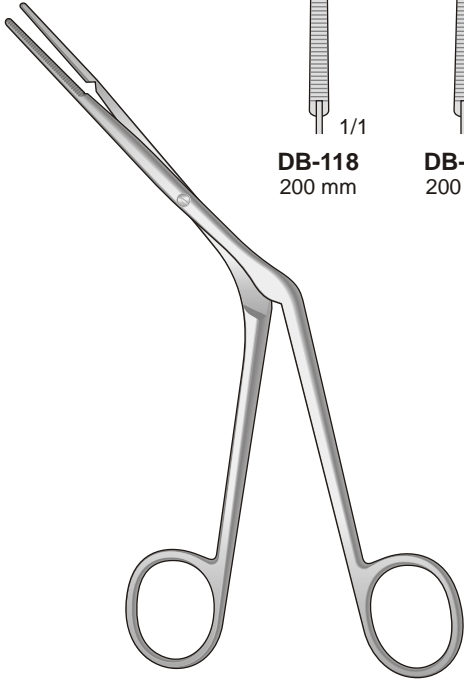

**WESTMACOTT  
DB-118/DB-119**  
200 mm

Spatulated Ovale  
Breast



Spatulated  
Breast

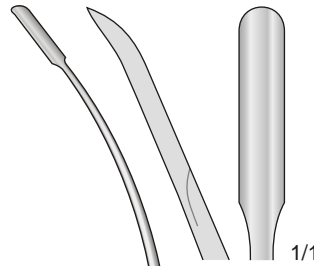

**Halb-Biegsam**  
Semi-malleable  
Semi malleabile  
Semi maleable  
Semi-souple

1/1

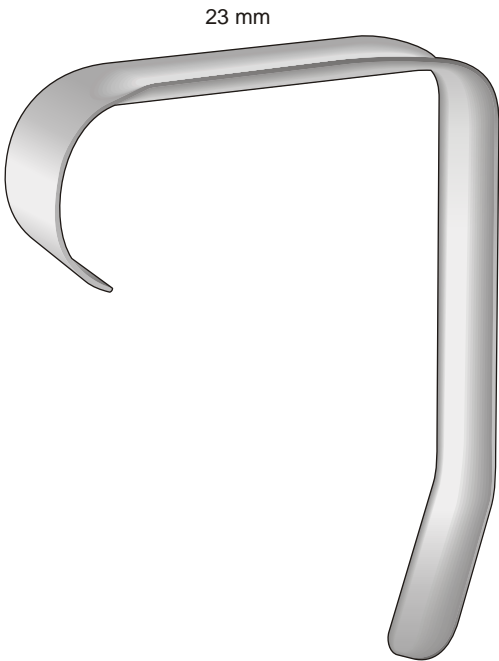

23 mm

**FACE-LIFT  
ES-163**  
120 mm



**CONVERSE  
DO-207**  
50 mm

**ES-219**  
270 mm

**ES-144**  
330 mm

**ES-149**  
390 mm

**Dissector  
Wundhaken**



**ES-110**  
125 mm

**Dissector  
Retractors**



**BT-21**  
110 mm

**Dissettori  
Divaricatori**

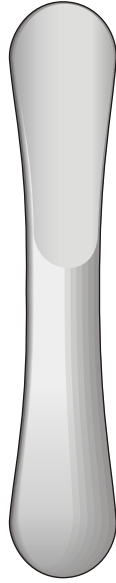

**JAEGER  
OM-09**  
110 mm

**Disecadores  
Separadores**

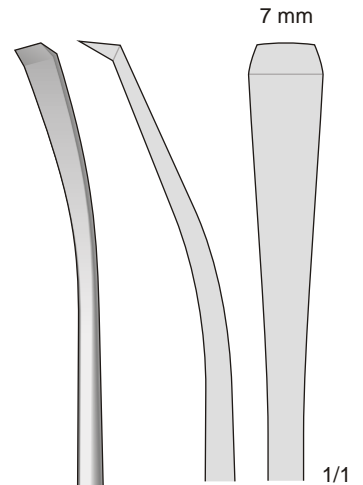

**Nasenflügelhaken  
Alar Retractor  
Divaricatore per alette nasali  
Separador para las alas nasales  
Ecarteur pour les ailes du nez**

Measuring and Sculpturing  
the lateral crus in open Rhinoplasty  
Scultura delle crus laterali  
nella Rinoplastica aperta

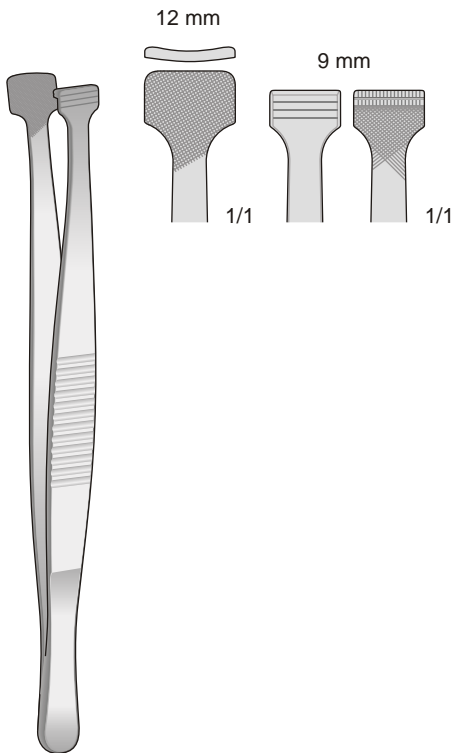

**MENEGHINI  
BD-350**  
125 mm

**MICHELI-PELLEGRINI  
FR-190**  
150 mm

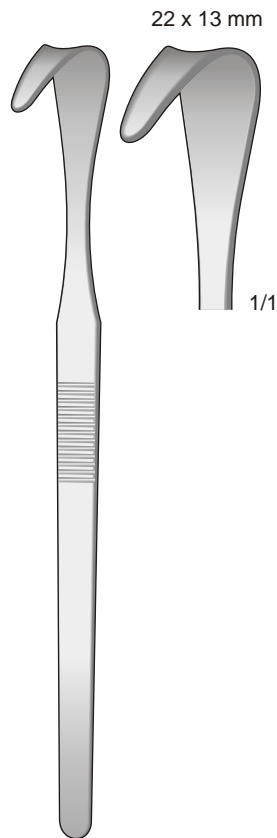

**COTTLE  
BT-138**  
150 mm

**MENEGHINI  
ES-221**  
215 mm

Dissector

Dissector

Dissettori

Discadores

Dissecteur

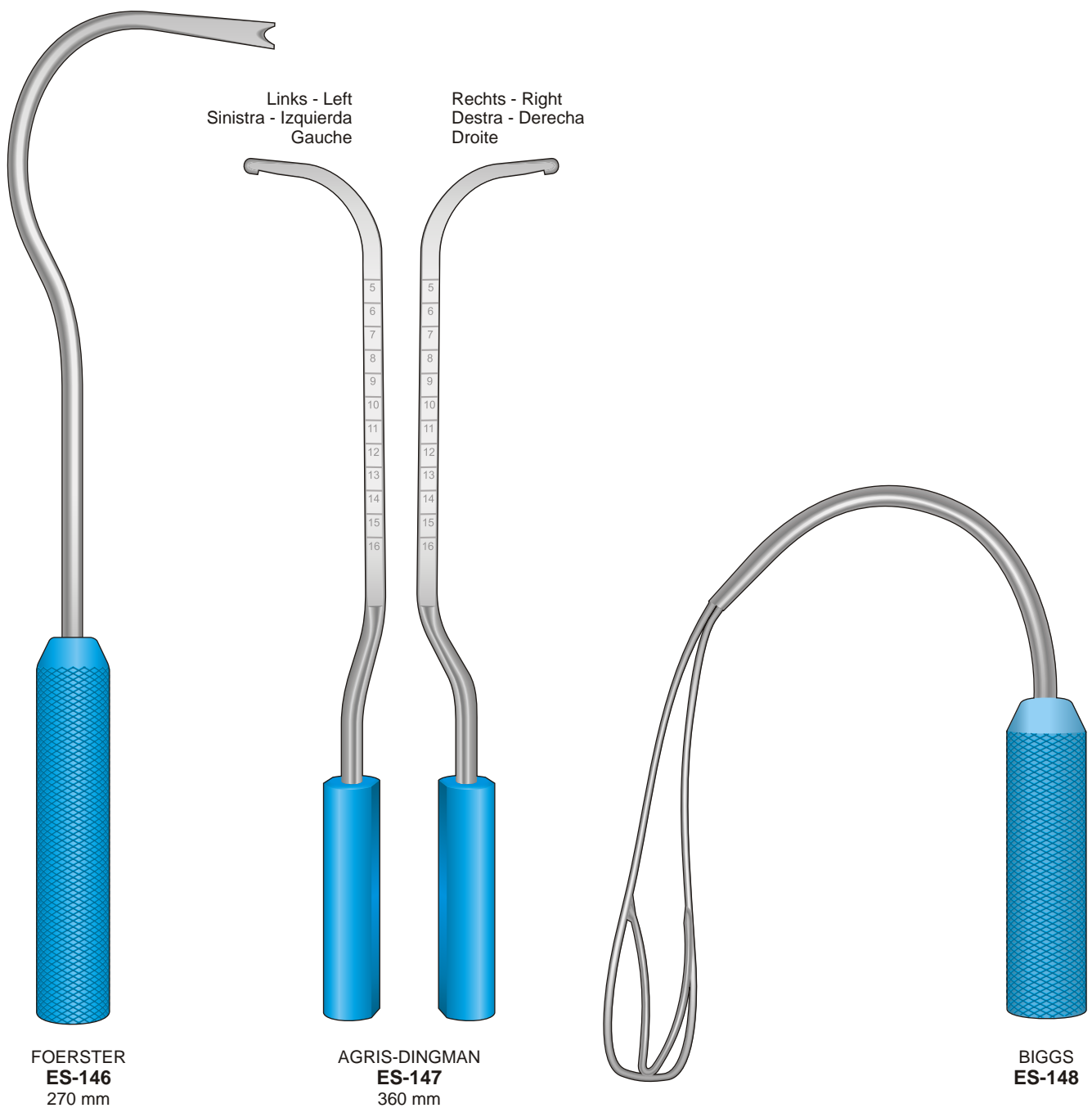

Areola-Marker

Areola Marking

Marca Areola

Apuntar Areola

Couteaux à mamelles

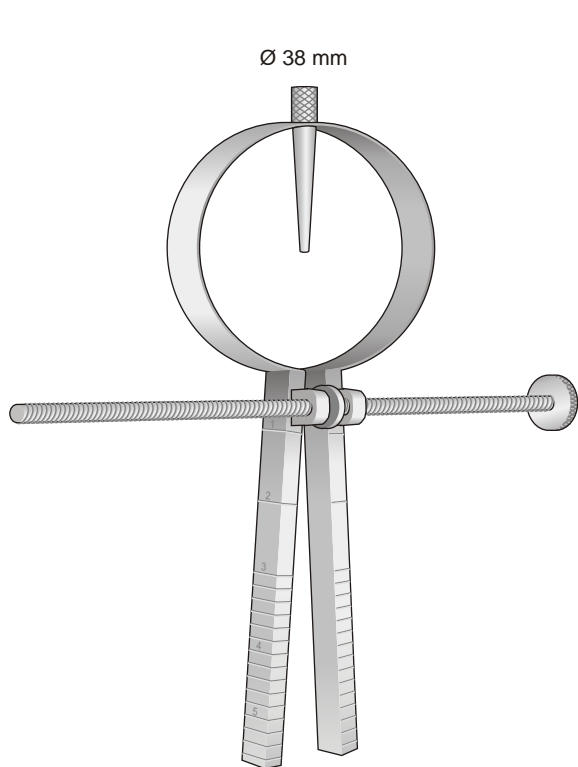

**ES-164**  
105 mm

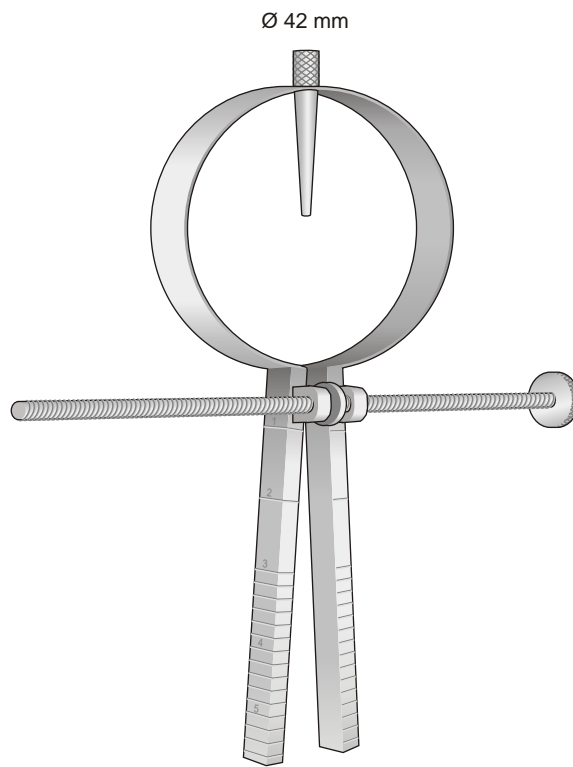

**ES-165**  
110 mm

Scharf - Sharp  
Taglienti - Cortante  
Tranchant

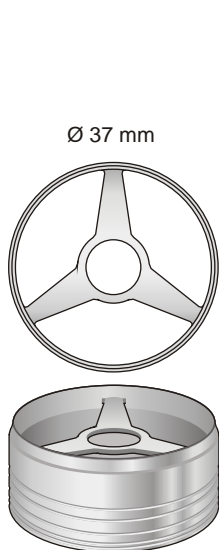

**ES-18S**  
37 mm

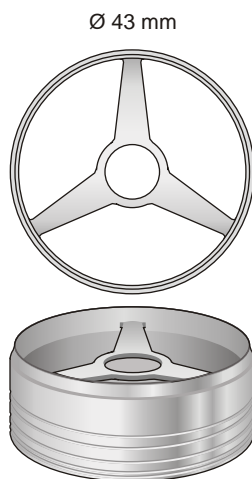

**ES-19S**  
43 mm

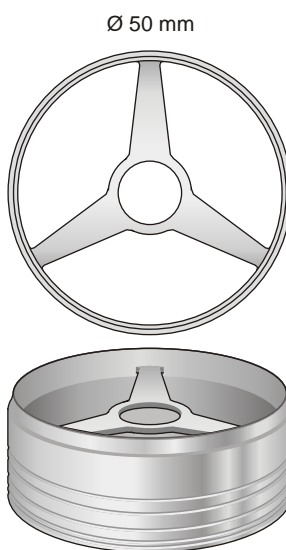

**ES-20S**  
50 mm

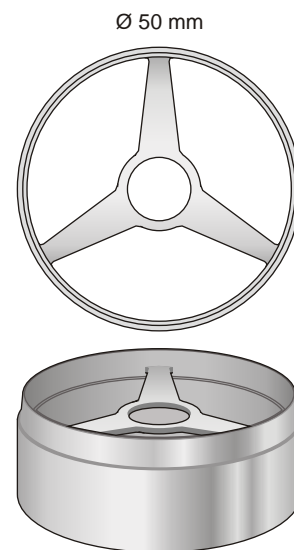

**ES-20**  
50 mm

Feine Wundhäkchen

Fine Retractors

Divaricatori fini

Separadores finas

Ecarteurs très fins

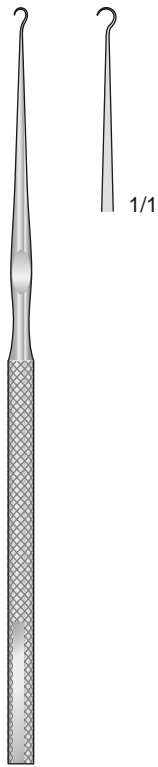

**KILNER**  
**BT-53**  
150 mm

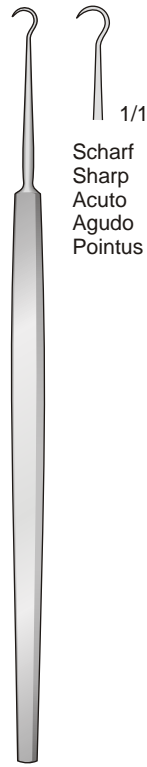

**FRAZIER**  
**BT-362** 130 mm  
**BT-363** 180 mm



**FRAZIER**  
**BT-364** 130 mm  
**BT-365** 180 mm

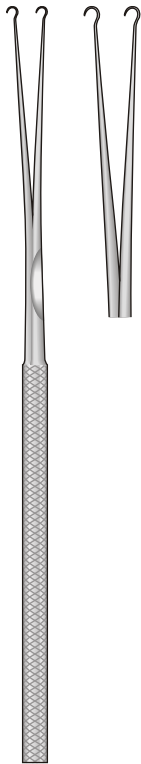

**BARSKY**  
**BT-370**  
150 mm

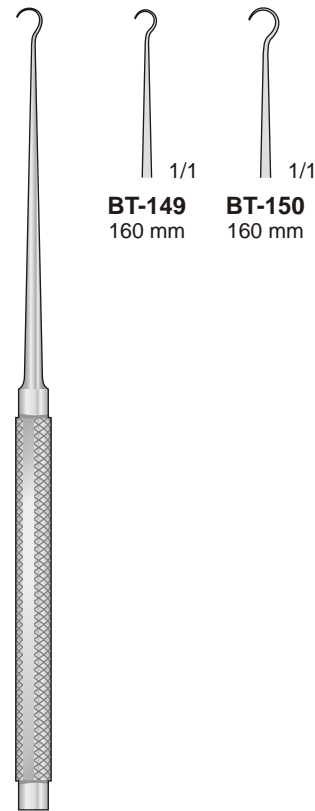

**KLEINERT-KUTZ**  
**BT-149/BT-150**  
160 mm

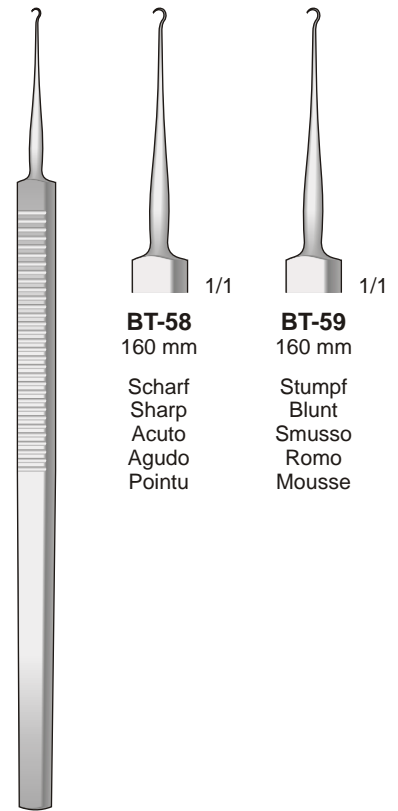

**GRAEFE**  
**BT-58/BT-59**  
160 mm

Scharf  
Sharp  
Acuto  
Agudo  
Pointus

Stumpf  
Blunt  
Smusso  
Romo  
Mousses

**BT-58**  
160 mm  
Scharf  
Sharp  
Acuto  
Agudo  
Pointu

**BT-59**  
160 mm  
Stumpf  
Blunt  
Smusso  
Romo  
Mousse



Wundhaken mit  
Fiberoptikstab oval

Retractors with  
Fiber optic oval

Divaricatore a  
fibra ottica ovale

Retractor con  
iluminación de luz fría

Ecarteur avec  
illumination à lumière froide

Sterilizable. Removable. Protected fiber-optic piece  
Oval Shaped optic end for great light field  
Retractor with concave blade for added operative space and visibility  
Equipped with universal adapters WOLF, STORZ, OLYMPUS

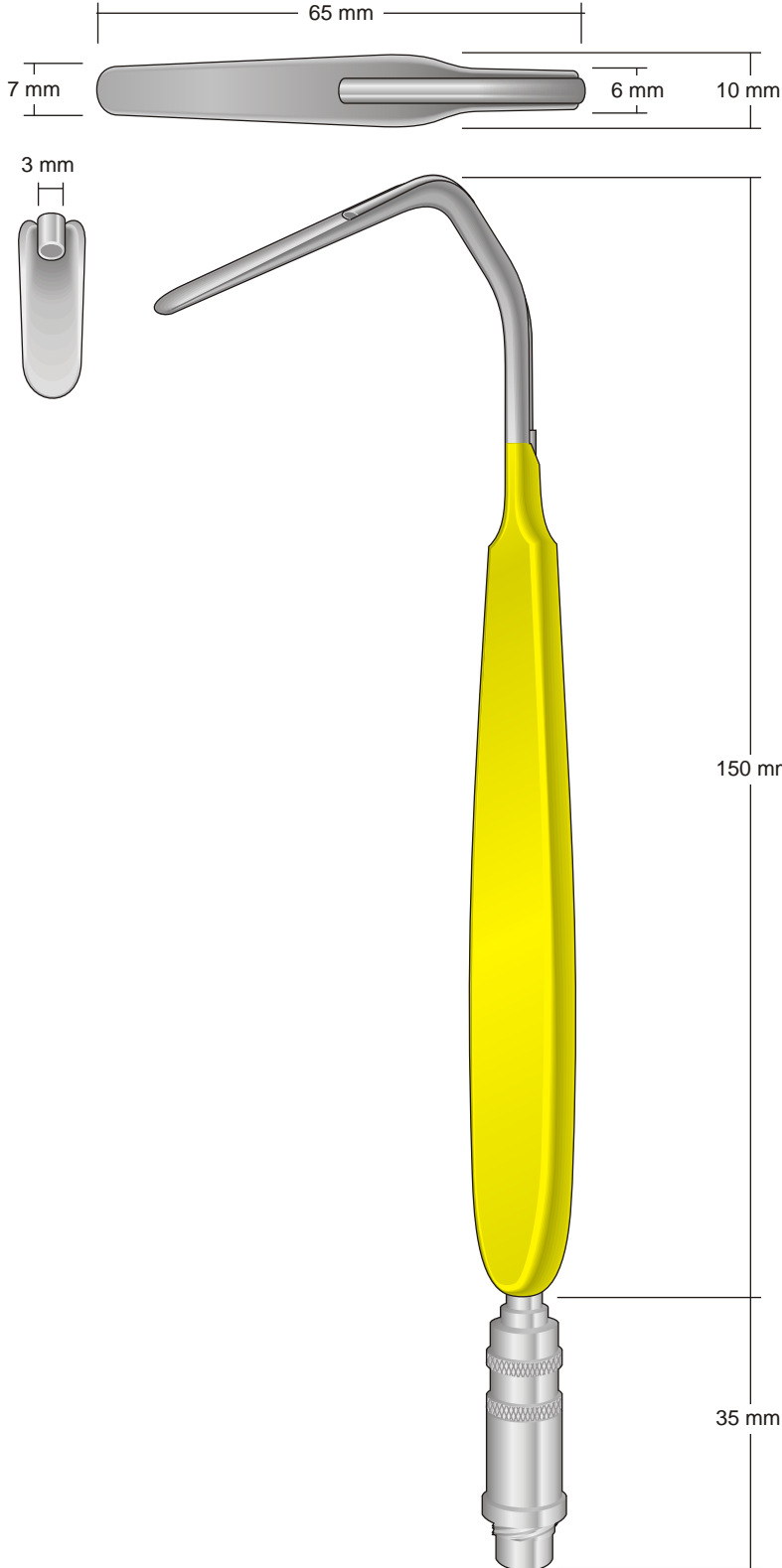

**DO-401**  
185 mm

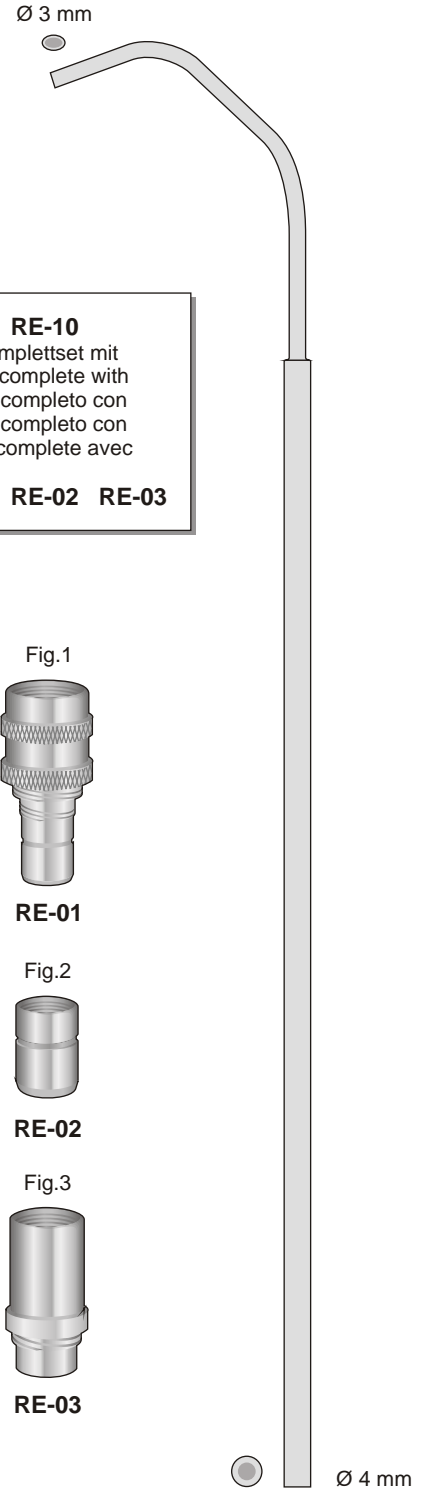

**DO-401R**  
182 mm

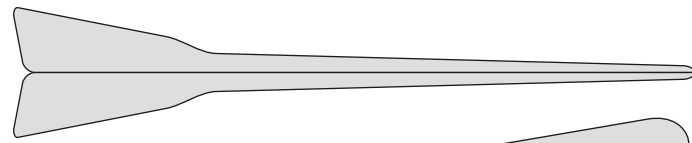

90 mm

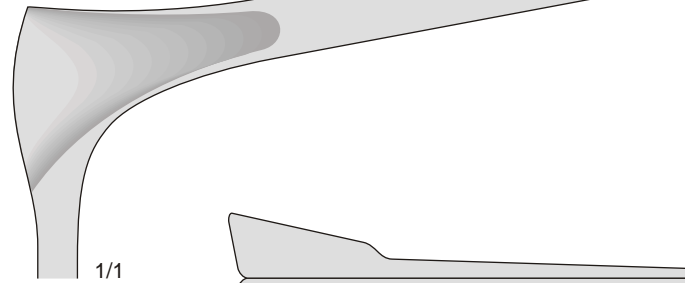

75 mm

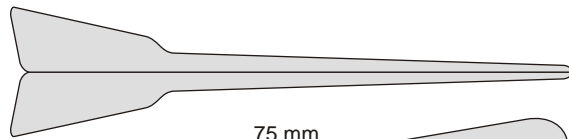

55 mm

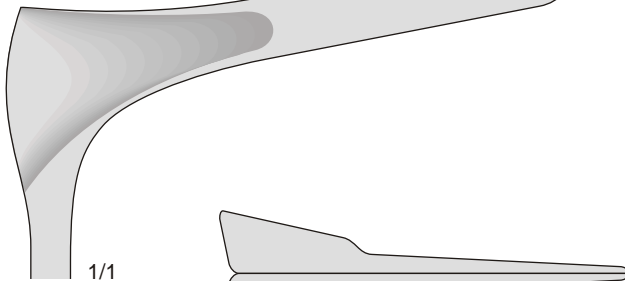

40 mm

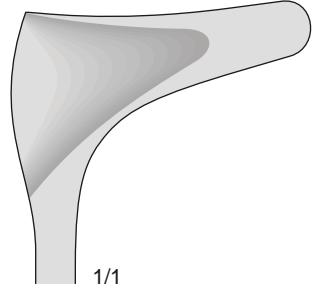
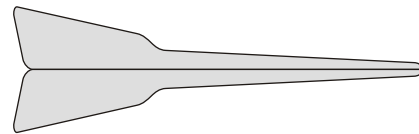

**OM-191**  
140 mm

**OM-192L**  
150 mm

**OM-192**  
150 mm

**OM-190**  
130 mm

Dünnes Blatt  
Thin valve  
Valve platte

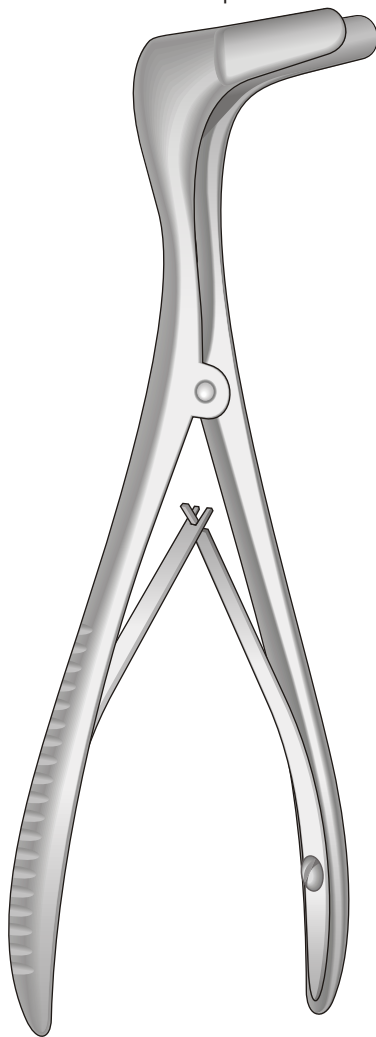

**KILLIAN**  
**OM-190/OM-192**

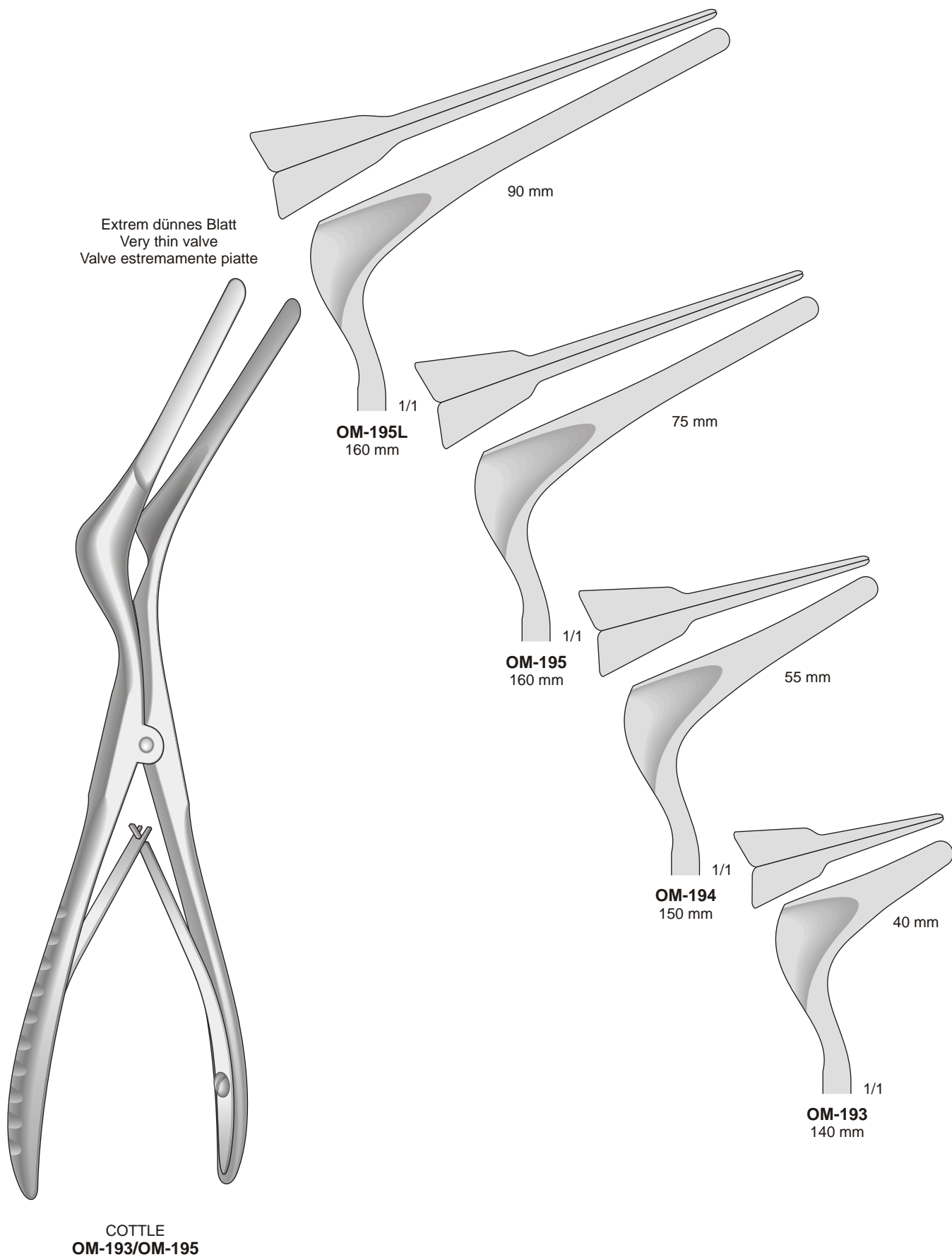

**Schwarz Verchromt**  
**Black Finish**  
**Cromato nero**

Extrem dünnes Blatt  
Very thin valve  
Valve estremamente piatte

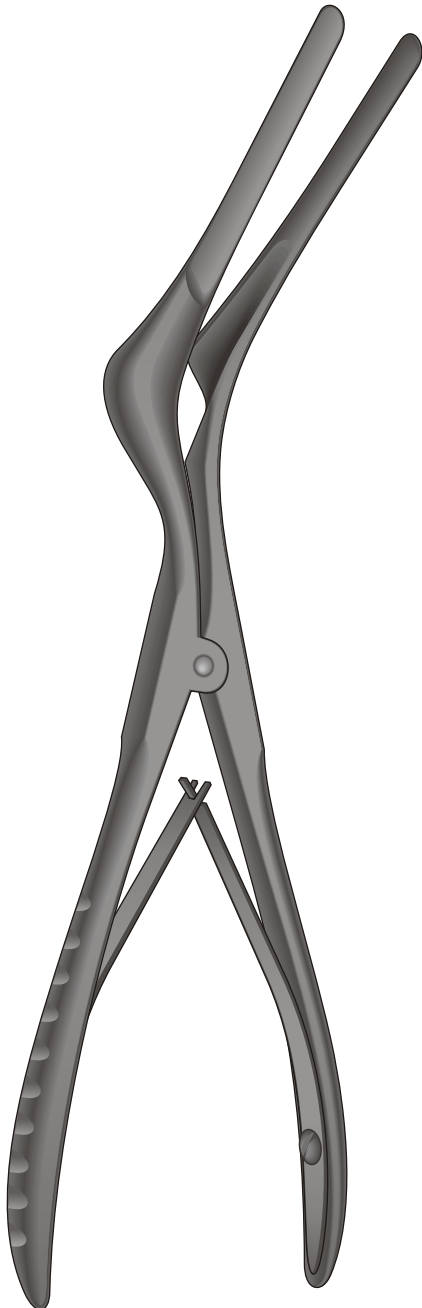

COTTLE  
**OM-196/OM-198**

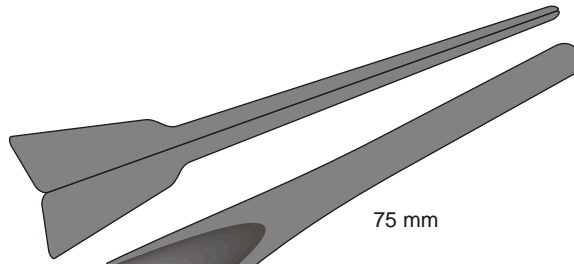

1/1  
**OM-198**  
160 mm

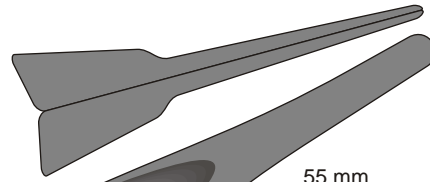

1/1  
**OM-197**  
150 mm

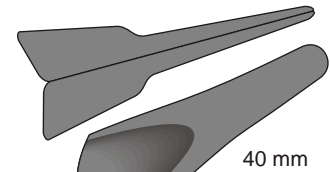

1/1  
**OM-196**  
140 mm

Nasen Spekula

Nasal specula

Speculum nasali

Espéculos nasales

Spéculums nasaux

Mit Fiberoptikstab  
 With Fiber optic illumination  
 Con illuminazione a fibre ottiche  
 Con iluminación de luz fría  
 Avec illumination à lumière froide

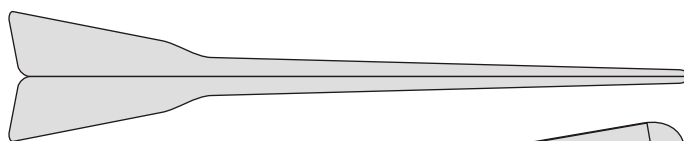

90 mm

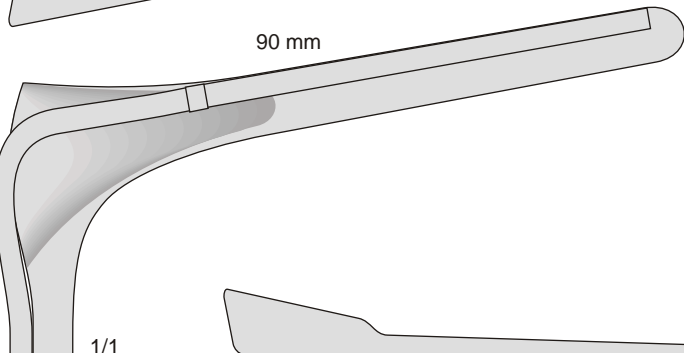

1/1

**OM-243**  
150 mm

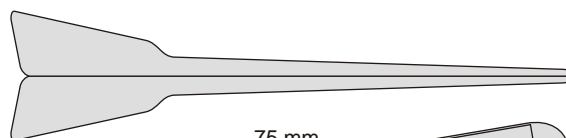

75 mm

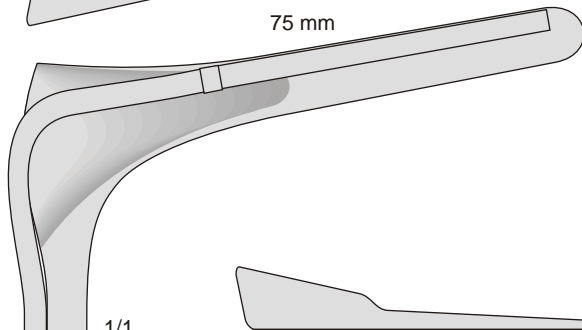

1/1

**OM-242**  
150 mm

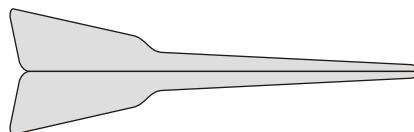

55 mm

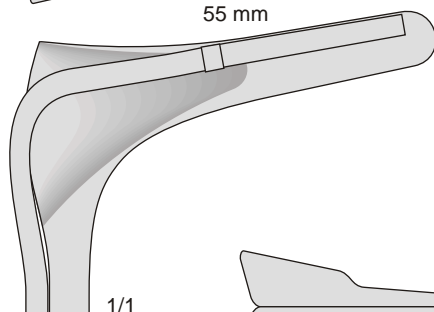

1/1

**OM-241**  
140 mm

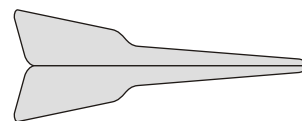

40 mm

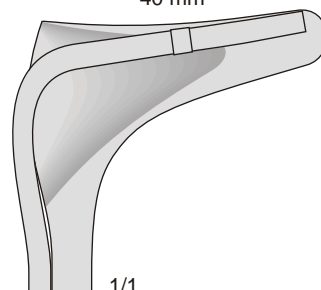

1/1

**OM-240**  
130 mm

Dünnes Blatt  
 Thin valve  
 Valve piatte

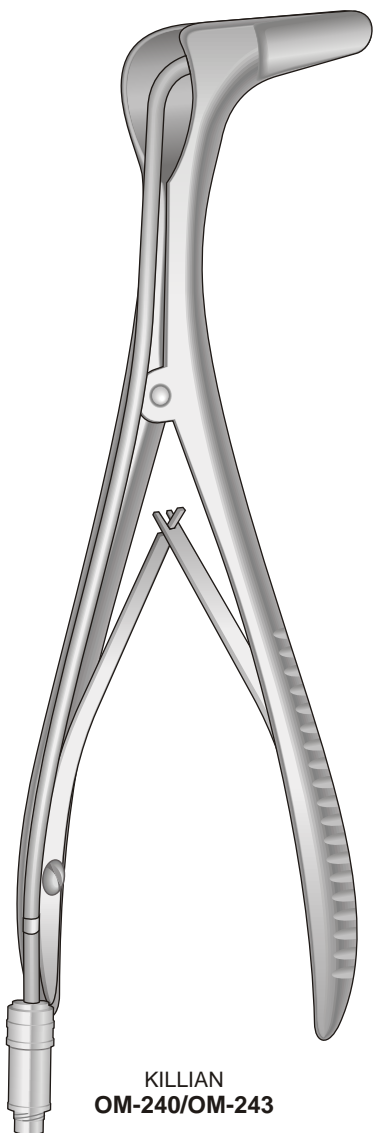

**KILLIAN**  
**OM-240/OM-243**

**Endoplastikinstrumente**

**Endoplastic Instruments**

**Strumenti per Endoplastica**

**Instrumentos para Endoplastica**

**Instruments pour Endoplastique**

Faßzange - Grasping Forceps  
Pinza da presa - Pinza para agarrar  
Pincès à préhension

130 mm

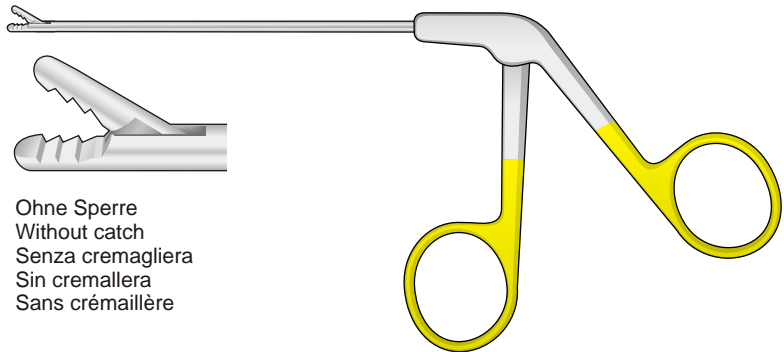

Ohne Sperre  
Without catch  
Senza cremagliera  
Sin cremallera  
Sans crémaillère

**FO-350**

Gerade - Straight  
Diritta - Recto - Droit



**FO-370**  
Ø 2,7 mm

30° rechts - right  
destra - derecha - droite



**FO-371**  
Ø 2,7 mm

30° links - left - sinistra  
izquierda - gauche



**FO-372**  
Ø 2,7 mm

Hakenstanzen mit Schaufel - Hook Punches with Scoop  
Pinze per biopsia con pala - Pinzas para biopsia con pala  
Pincès à biopsie à pelle

130 mm

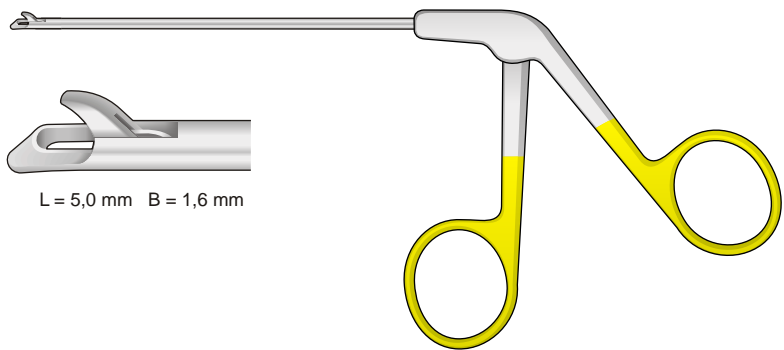

L = 5,0 mm B = 1,6 mm

**FO-370/FO-372**

Gerade - Straight  
Diritta - Recto - Droit



**FO-390**  
Ø 2,7 mm

30° rechts - right  
destra - derecha - droite



**FO-391**  
Ø 2,7 mm

30° links - left - sinistra  
izquierda - gauche



**FO-392**  
Ø 2,7 mm

15° auf - up - sopra



**FO-397**  
Ø 2,7 mm

Hakenschere - Hook Scissors  
Pinze a gancio - Tijeras de gancho  
Pincès - ciseaux

130 mm

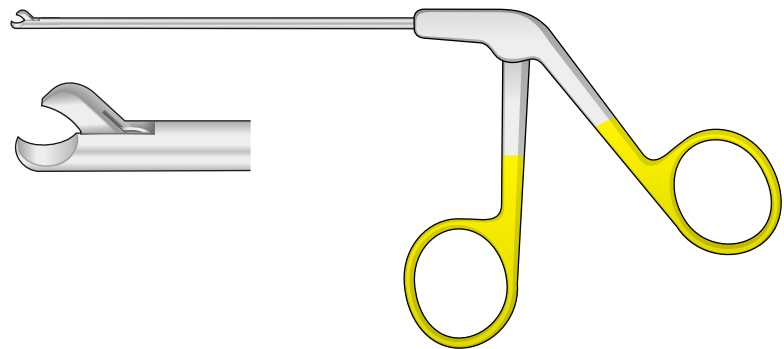

**FO-390/FO-397**

Scheren Gezahnt

Serrated scissors

Forbici dentellate

Tijeras dentadas

Ciseaux dentelé

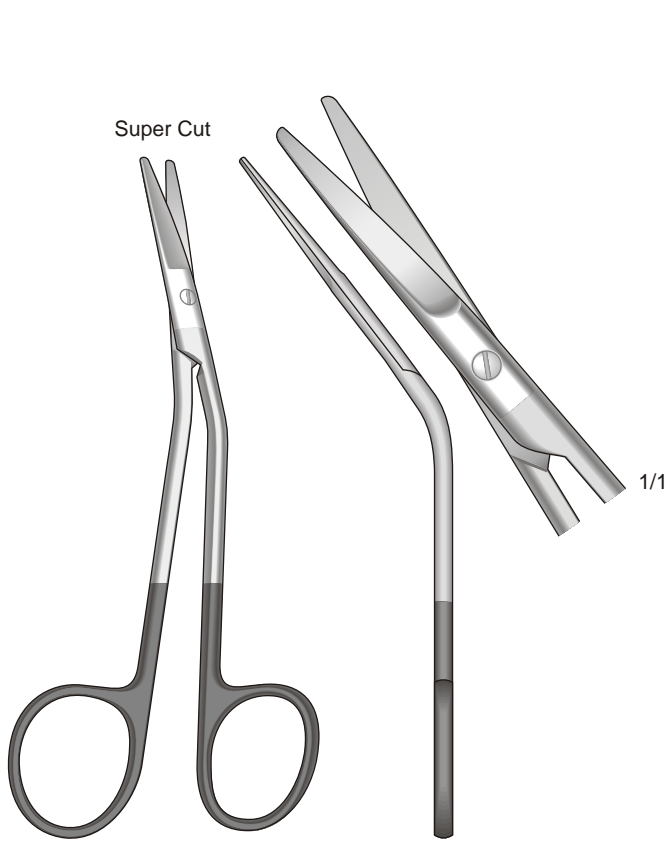

FOMON  
FG-192  
130 mm

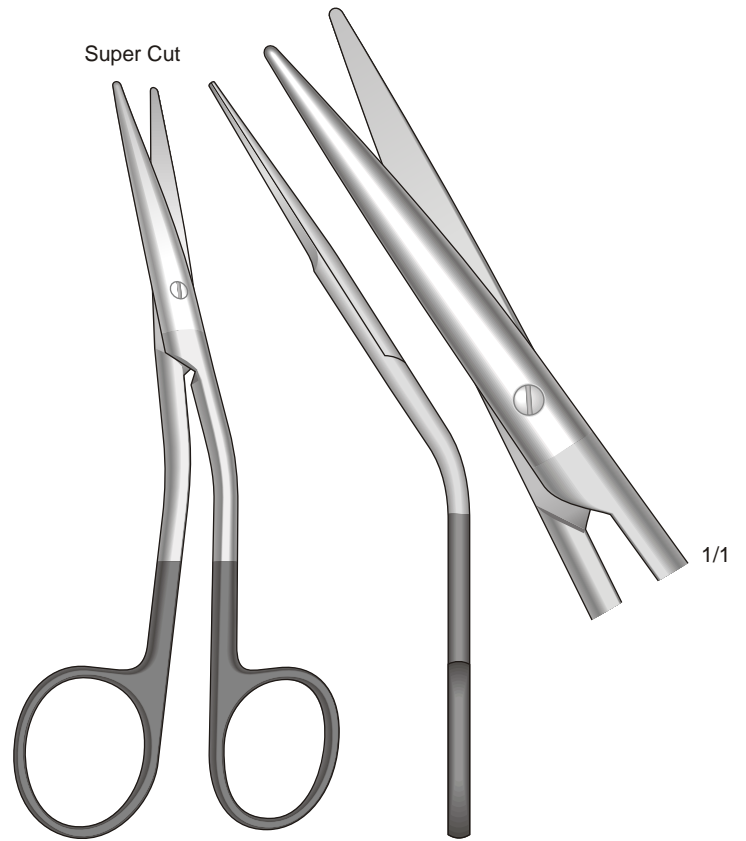

COTTLE  
FG-193  
160 mm

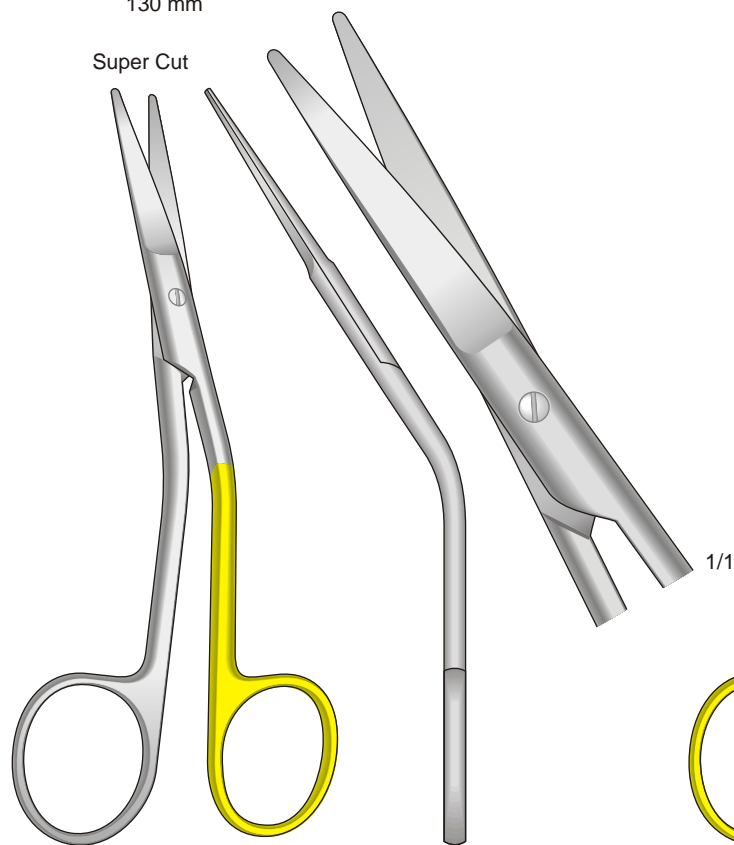

COTTLE  
FG-194  
160 mm

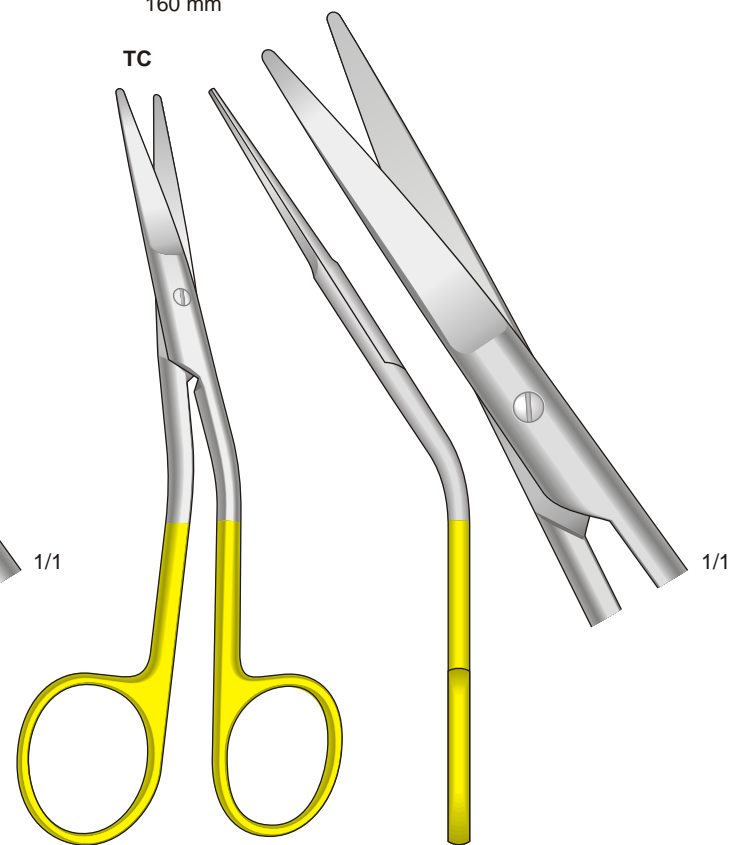

COTTLE  
FG-195  
160 mm

Mit einer Schneide gezahnt  
With one blade serrated  
Con una lama zigrinata  
Con una hoja dentada  
Avec lame dentèle

Super Cut

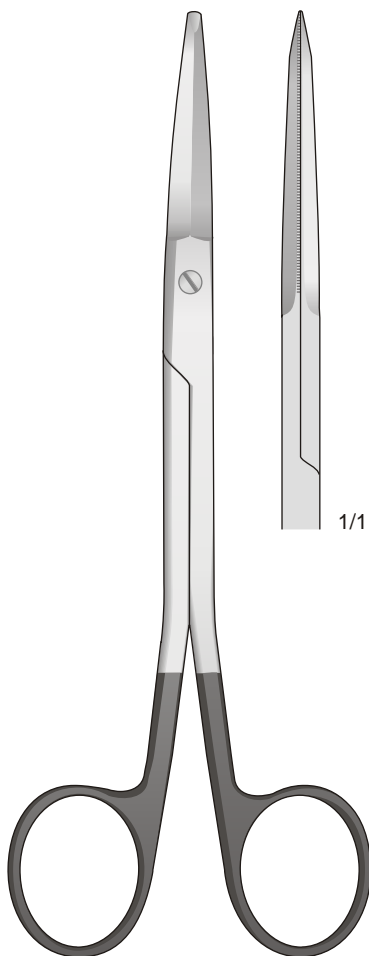

**FACE-LIFT**  
**FM-308**  
160 mm

Mit einer Schneide gezahnt  
With one blade serrated  
Con una lama zigrinata  
Con una hoja dentada  
Avec lame dentèle

Super Cut

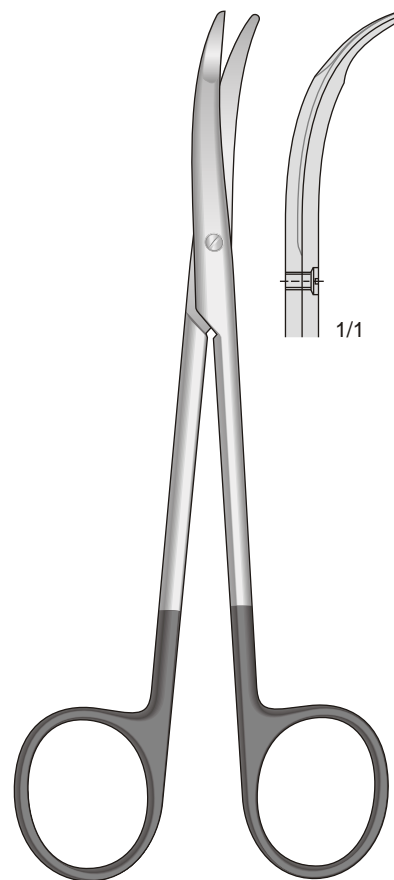

**FOMON**  
**FG-163**  
140 mm

Mit einer Schneide gezahnt  
With one blade serrated  
Con una lama zigrinata  
Con una hoja dentada  
Avec lame dentèle

Super Cut

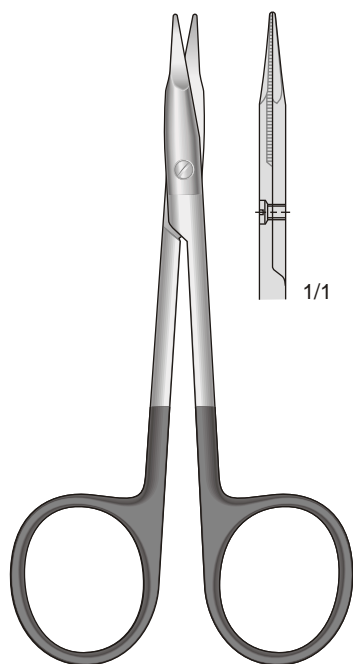

**STEVENS**  
**FM-302**  
105 mm



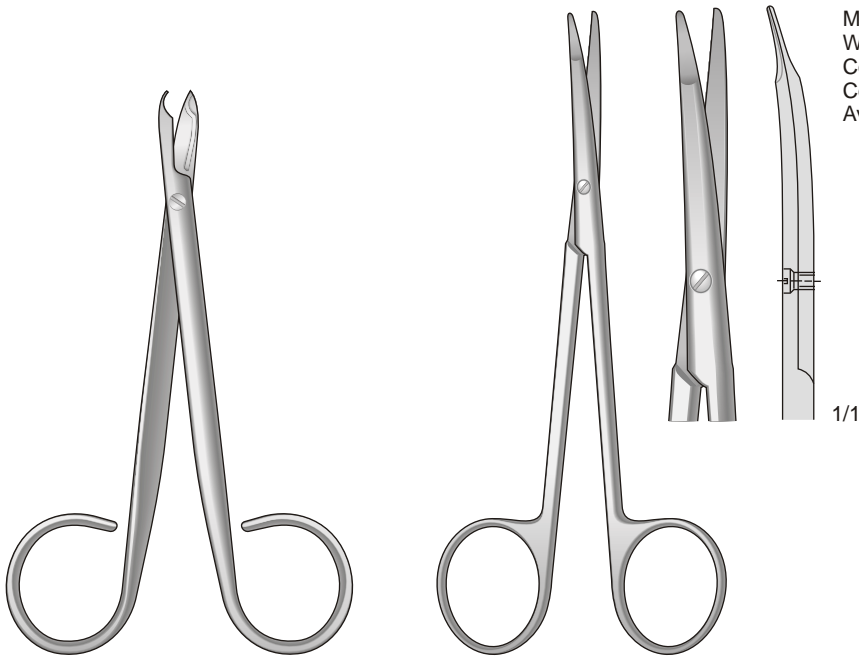

Mit einer Schneide gezahnt  
 With one blade serrated  
 Con una lama zigrinata  
 Con una hoja dentada  
 Avec lame dentée

**SC-3**  
110 mm

**KILNER  
FG-121**  
130 mm

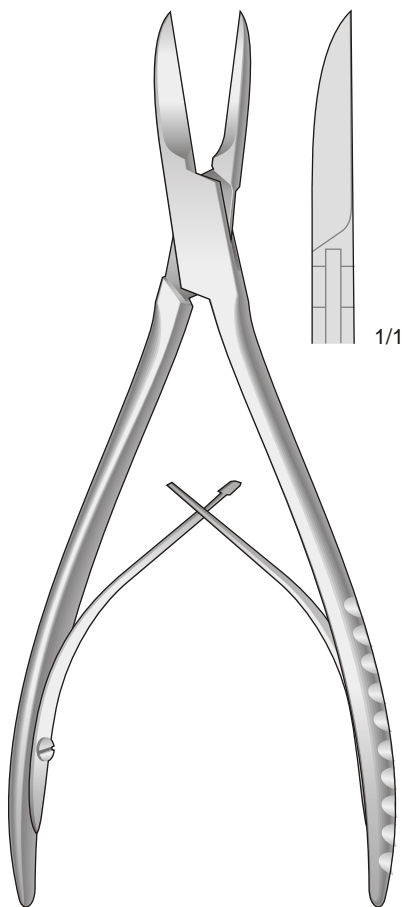

**COTTLE-KAZANJIAN  
FO-95**  
190 mm

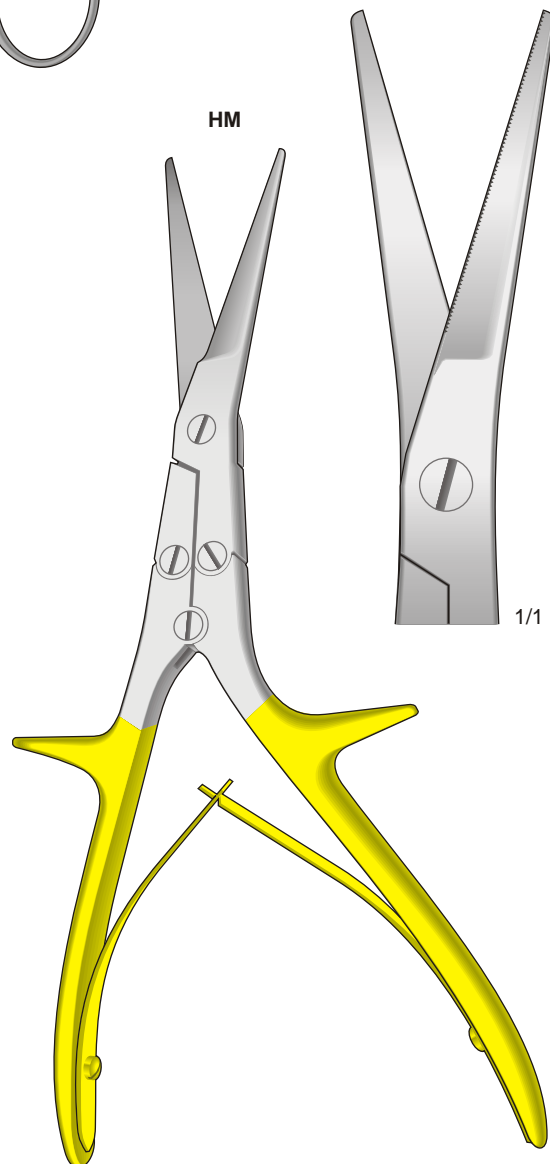

**GORNEY  
FO-190**  
205 mm

Osteotome

Osteotomes

Osteotomi

Osteòtomos

Ostéotomes



**JOSEPH  
FR-34**  
150 mm



**TESSIER  
FL-413/FL-416**  
160 mm



**FL-413**  
2 mm



**FL-414**  
3 mm



**FL-415**  
5 mm



**FL-416**  
7 mm

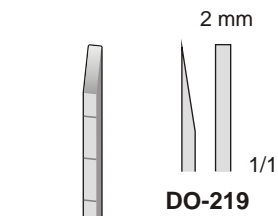

**COTTLE  
DO-219**  
180 mm

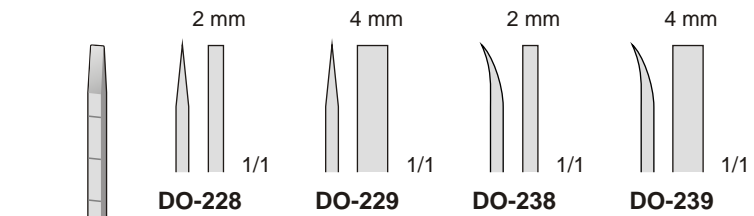

**COTTLE  
DO-228/DO-239**  
180 mm

Osteotome

Osteotomes

Osteotomi

Osteòtomos

Ostéotomes

2 mm

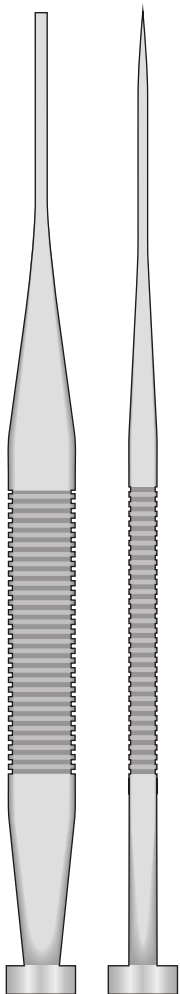

**DO-113**  
170 mm

3 mm

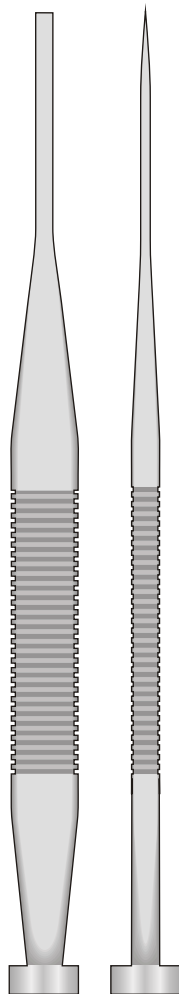

**DO-114**  
170 mm

4 mm

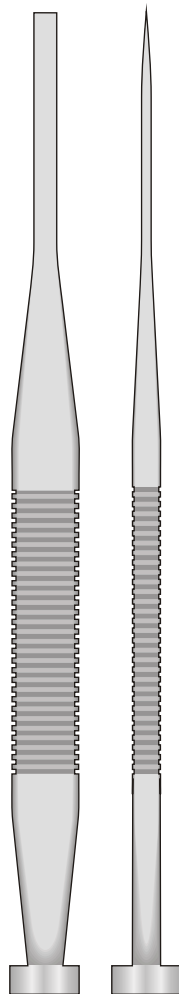

**DO-115**  
170 mm

4 mm

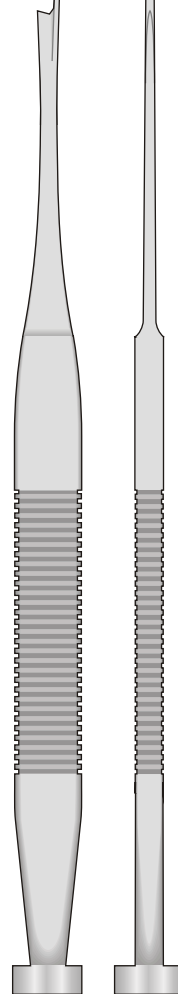

**DO-116**  
170 mm

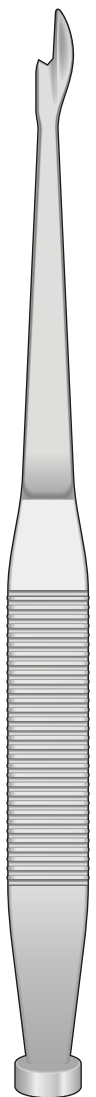

**DO-135**  
185 mm

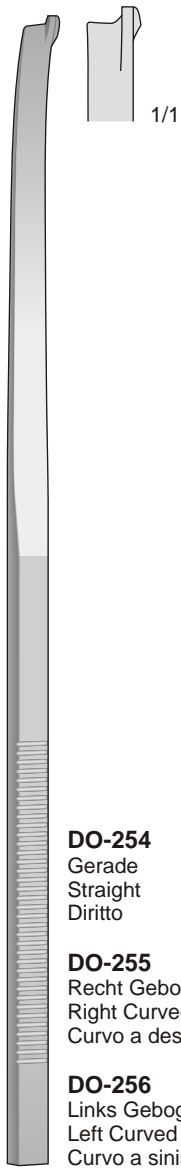

**DO-254**  
Gerade  
Straight  
Diritto

**DO-255**  
Recht Gebogen  
Right Curved  
Curvo a destra

**DO-256**  
Links Gebogen  
Left Curved  
Curvo a sinistra

GUNTER  
**DO-254/DO-256**  
200 mm

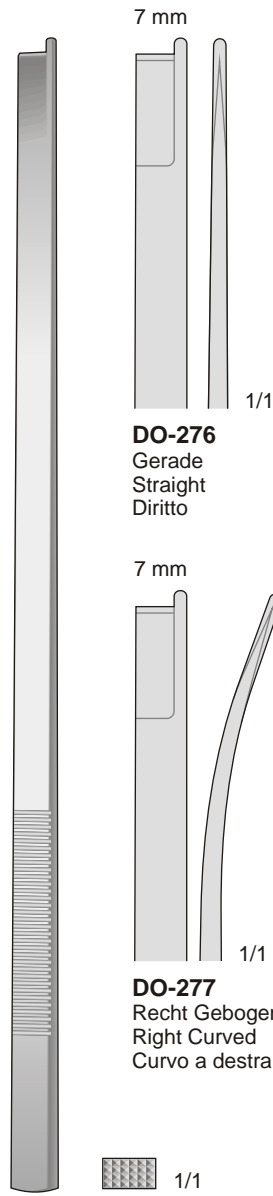

**DO-276**  
Gerade  
Straight  
Diritto

**DO-277**  
Recht Gebogen  
Right Curved  
Curvo a destra

**DO-278**  
Links Gebogen  
Left Curved  
Curvo a sinistra

NEIVERT-ANDERSON  
**DO-276/DO-278**  
205 mm

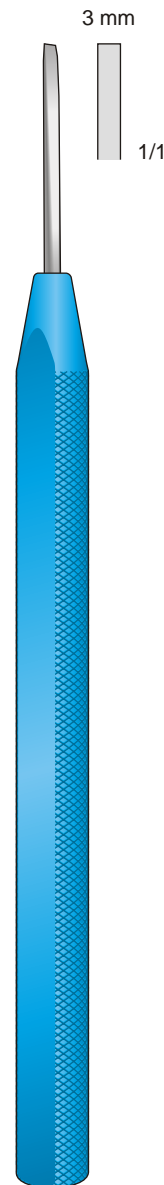

REES  
**DO-275**  
205 mm

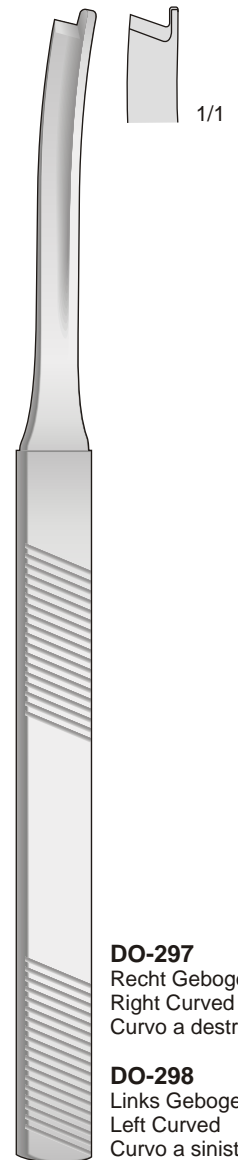

**DO-297**  
Recht Gebogen  
Right Curved  
Curvo a destra

**DO-298**  
Links Gebogen  
Left Curved  
Curvo a sinistra

RISTOW  
**DO-297/DO-298**  
205 mm

Osteotome

Osteotomes

Osteotomi

Osteòtomos

Ostéotomes

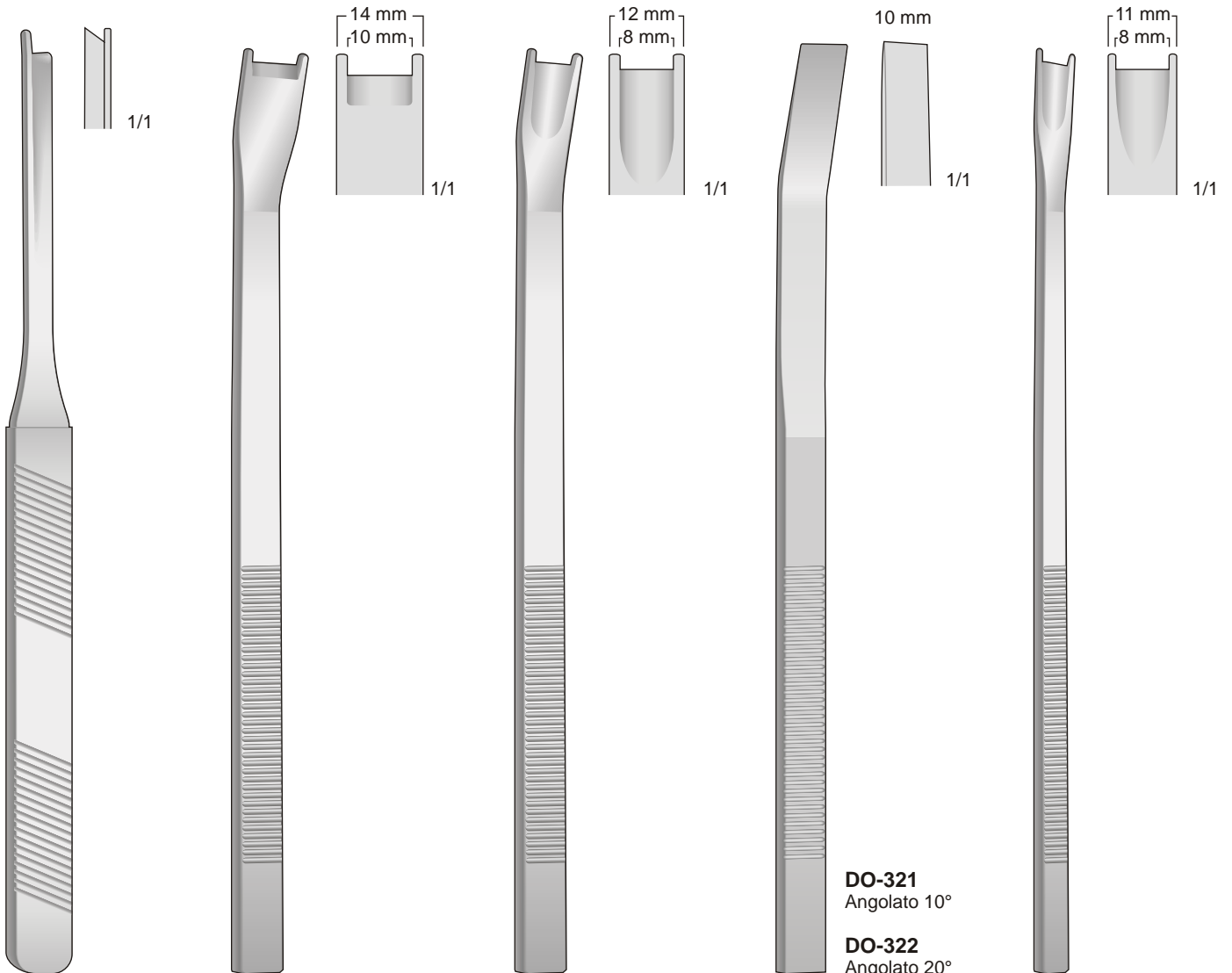

**PARKES  
DO-253**  
180 mm

**DANIEL  
DO-268**  
180 mm

**DANIEL  
DO-269**  
180 mm

**SHEEN  
DO-321/DO-322**  
180 mm

**DO-321**  
Angolato 10°

**DO-322**  
Angolato 20°

**PARKES  
DO-320**  
180 mm

Osteotome mit  
Doppelt Protezion

Osteotome with  
Double Guarded

Osteotomi con  
doppia protezione

Osteotom con  
doble protezion

Osteotome avec  
double protection

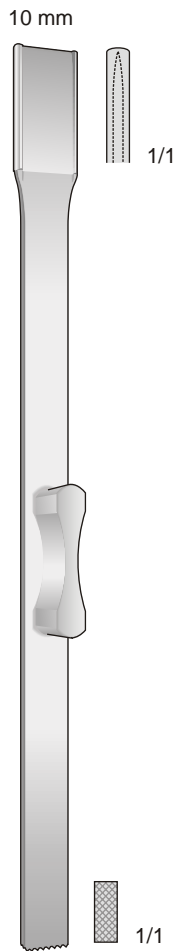

**DO-208**  
160 mm

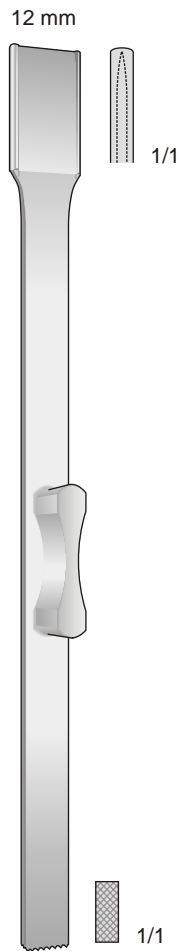

**DO-209**  
160 mm

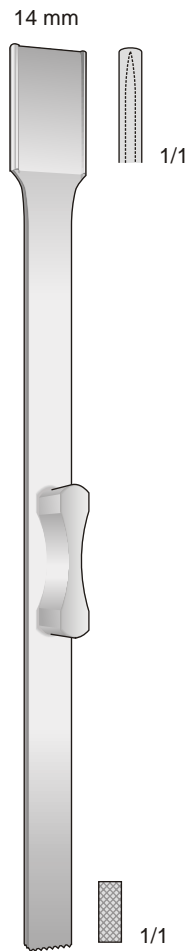

**DO-210**  
160 mm

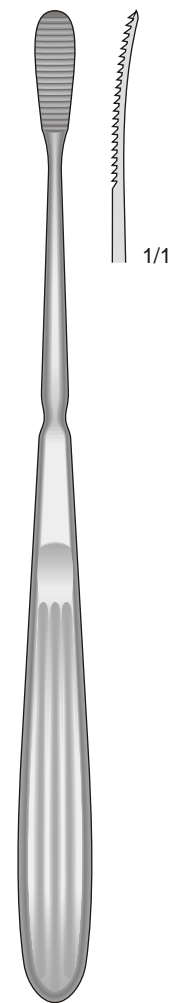

**DO-300**  
190 mm



**DO-267**  
190 mm

Knochenfeilen

Bone files

Lime per osso

Limas para huesos

Limes à os

Universal Adapter for Syringe

Aluminium Blau  
Aluminium Blue  
Alluminio Blu  
Aluminio Azul  
Aluminium Bleu



ES-02

Diamantaufilage  
Diamond Jaw  
Punte diamantate

7 mm

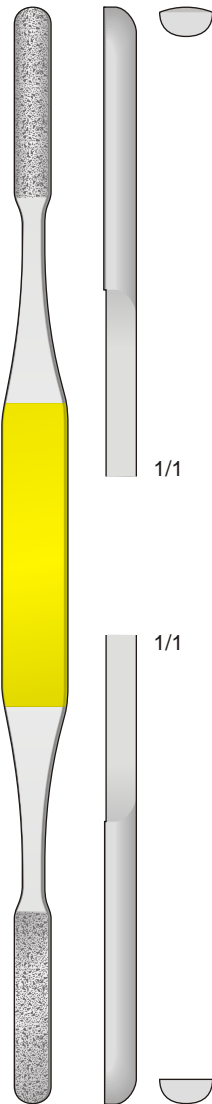

DO-316  
215 mm

Griff Rostfrei  
Stainless Steel Handle  
Manico in acciaio Inox  
Mango de acero inoxidable  
Manche en acier inoxydable

Ø 15 mm

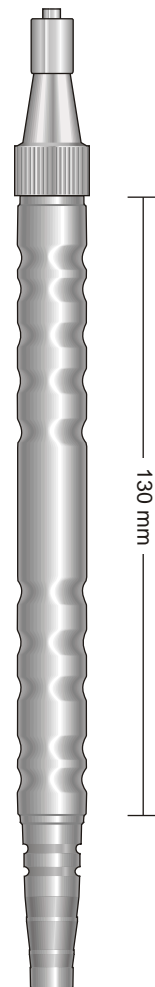

ES-29  
195 mm

130 mm

Rostfreies Verbindungsteil  
zum Kanüle-Nadel  
Connection piece  
for cannula-needles  
Raccordo inox  
per cannula-ago  
Juntura inox  
para jeringa-agujas  
Adapter en acier  
pour canule-aiguilles



ES-04

Intranasal Brecher  
Intranasal Hammer  
Martello intranasale



QUISLING  
FL-137  
175 mm

Mikro Pinzetten

Delicate forceps

Micro Pinzette

Pinzas finos

Micro pinces

**Mikro Precision Pinzetten**

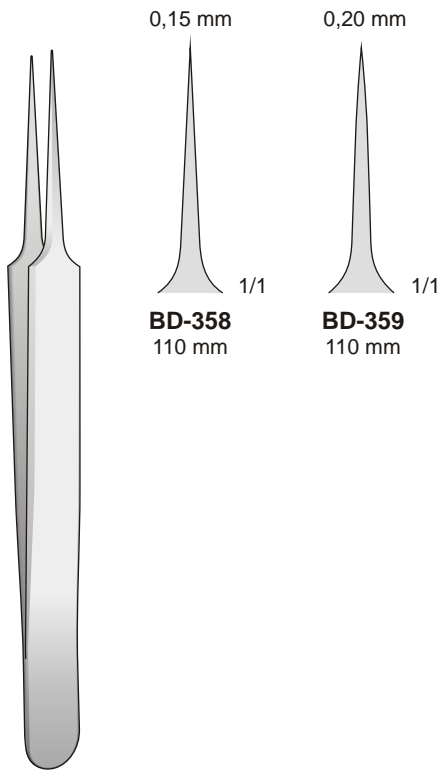

**BD-358**  
110 mm

**BD-359**  
110 mm

**BD-358/BD-359**  
110 mm

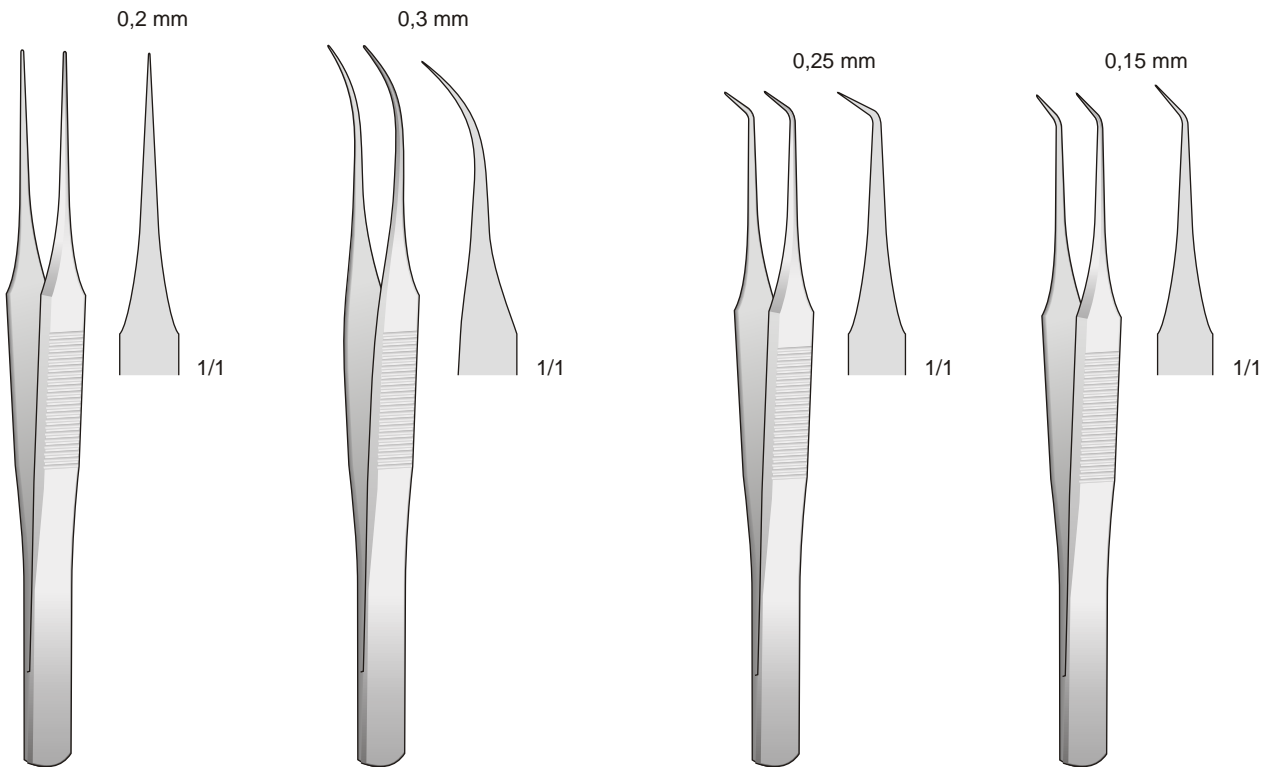

**BD-360**  
110 mm

**BD-361**  
110 mm

**BD-362**  
100 mm

**BD-363**  
100 mm



Mikro Pinzetten

Delicate forceps

Micro Pinzette

Pinzas finos

Micro pinces

**Mikro Precision Pinzetten**

Mikro diamantiertes Maul - Micro Diamond Jaw  
 Micro punta diamantata - Micro boca diamantada  
 Micro mors diamanté



1/1  
 1x2 Zähne  
 1x2 Tooth  
 1x2 Denti  
 1x2 Dientes  
 1x2 Dents



1/1  
 9x9 Zähne  
 9x9 Tooth  
 9x9 Denti  
 9x9 Dientes  
 9x9 Dents

CASTROVIEJO  
**BD-347** 0.5 mm  
**BD-348** 0.9 mm  
 120 mm

BROWN  
**BD-349**  
 120 mm

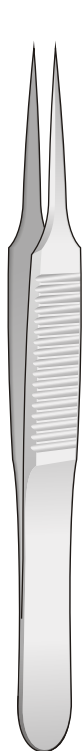

0,4 mm  
 1/1

**BD-364**  
 110 mm



0,4 mm  
 1/1

**BD-365**  
 110 mm



0,4 mm  
 1/1

**BD-366**  
 130 mm



0,4 mm  
 1/1

**BD-367**  
 130 mm

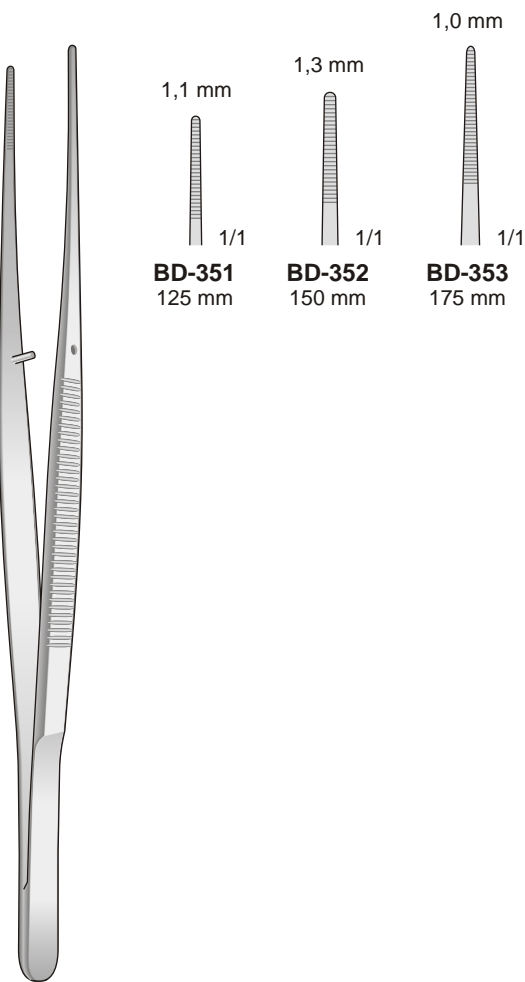

**BD-351/BD-353**

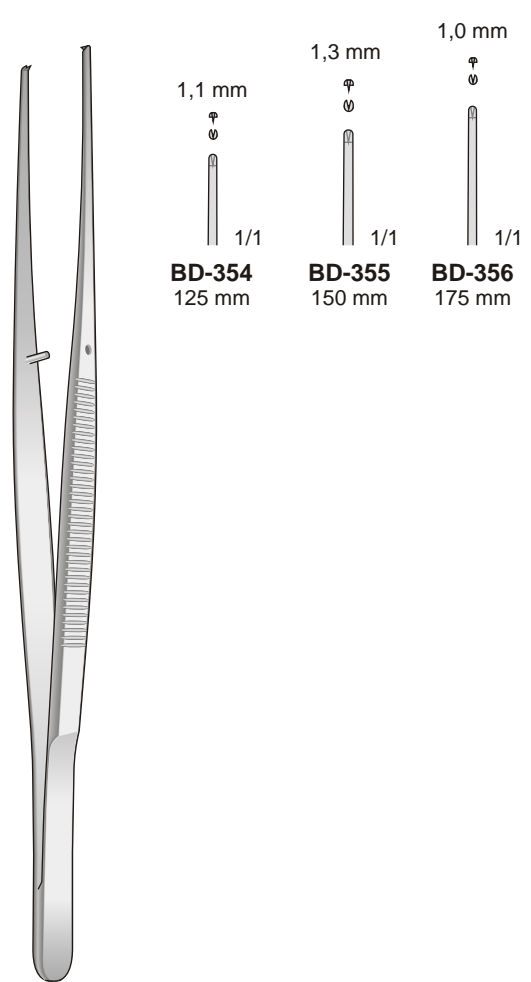

**BD-354/BD-355**

Chirurgische Pinzetten  
Anatomische Pinzetten

Tissue forceps  
Dressing forceps

Pinzette chirurgiche  
Pinzette anatomiche

Pinzas quirúrgicas  
Pinzas de diseccion

Pinces chirurgicales  
Pinces anatomiques

Mit Fadenplatte  
With tying platform  
Con piano prendifilo  
Con plataforma  
Avec plateaux pour monofil

1,0 mm

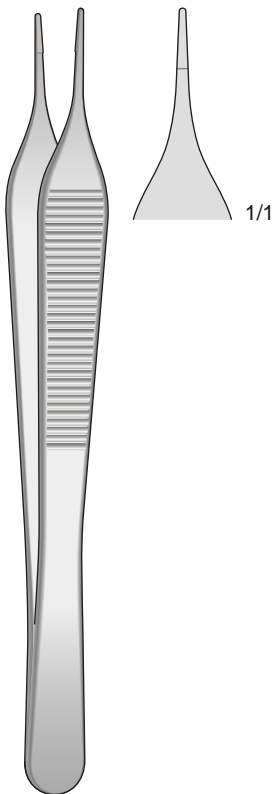

ADSON  
**BD-370**  
120 mm

Mit Fadenplatte  
With tying platform  
Con piano prendifilo  
Con plataforma  
Avec plateaux pour monofil

1,0 mm

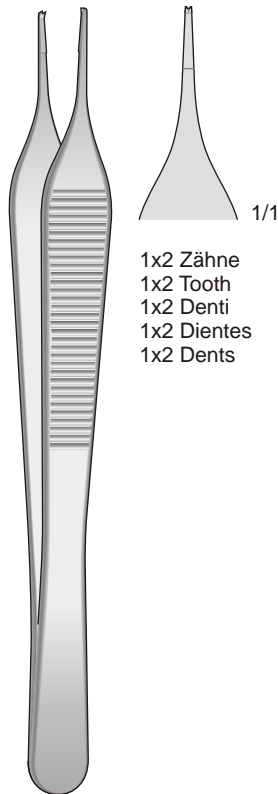

ADSON  
**BD-371**  
120 mm

1x2 Zähne  
1x2 Tooth  
1x2 Denti  
1x2 Dientes  
1x2 Dents

Extra fein  
Extra fine  
Extra fine

Gebogen  
Curved  
Curva

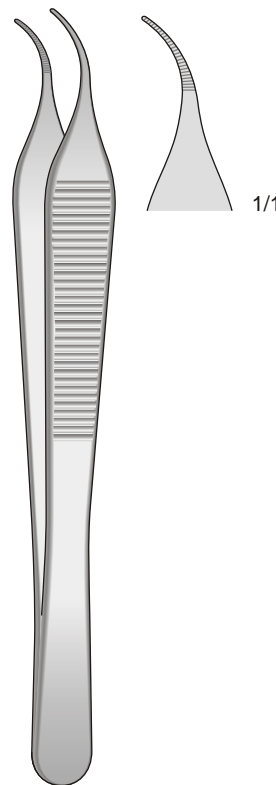

MICRO-ADSON  
**BD-372**  
120 mm

Extra fein  
Extra fine  
Extra fine

Gebogen  
Curved  
Curva

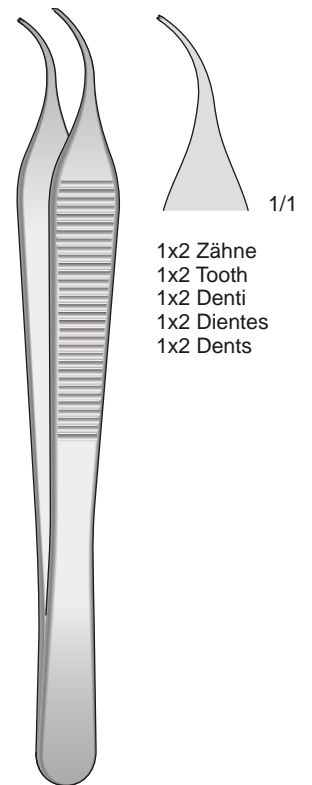

MICRO-ADSON  
**BD-373**  
120 mm

1x2 Zähne  
1x2 Tooth  
1x2 Denti  
1x2 Dientes  
1x2 Dents

Chirurgische Pinzetten  
Anatomische Pinzetten

Tissue forceps  
Dressing forceps

Pinzette chirurgiche  
Pinzette anatomiche

Pinzas chirurgicalas  
Pinzas de diseccion

Pincas chirurgicales  
Pincas anatomiques

TC

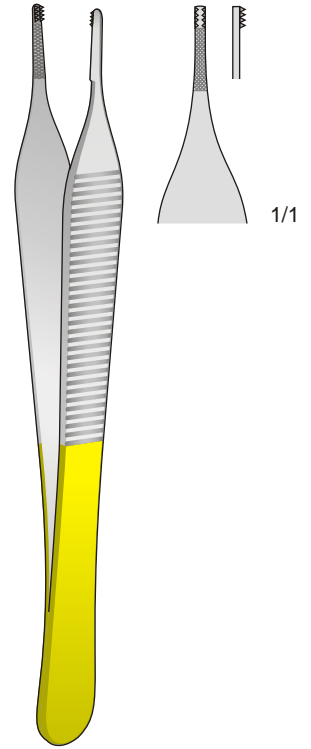

**ADSON-BROWN  
BD-253  
120 mm**

Kreuzgerieft  
Cross serrated  
Zigrinata a croce  
Estrizada a cruz  
Striéé

Abgewinkelt  
Angled  
Angolata

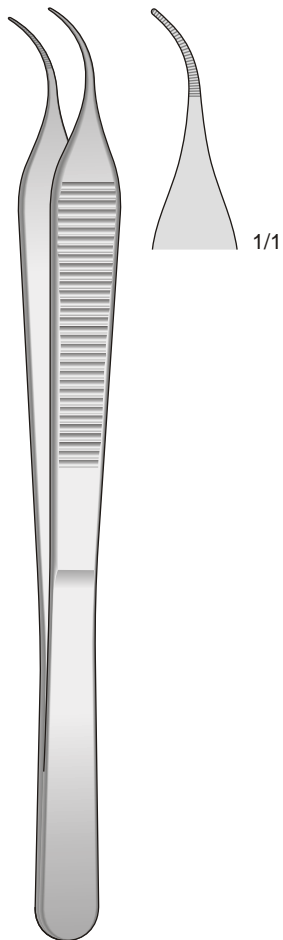

**MICRO-ADSON  
BD-374  
150 mm**

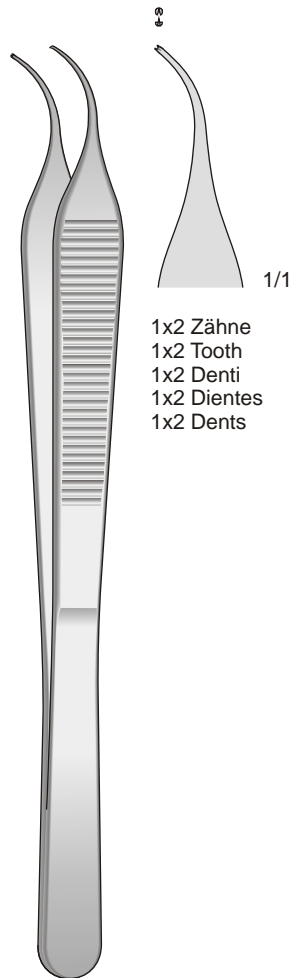

**MICRO-ADSON  
BD-375  
150 mm**

1x2 Zähne  
1x2 Tooth  
1x2 Denti  
1x2 Dientes  
1x2 Dents

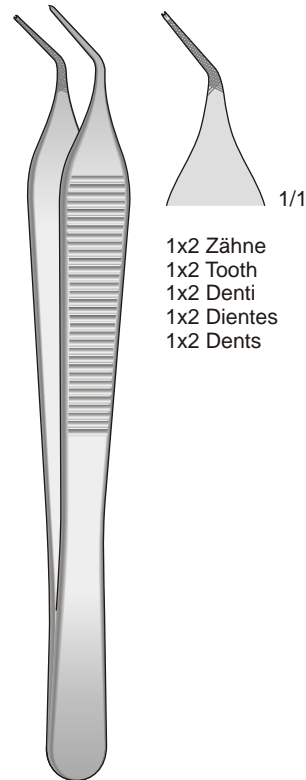

**MICRO-ADSON  
BD-376  
120 mm**

1x2 Zähne  
1x2 Tooth  
1x2 Denti  
1x2 Dientes  
1x2 Dents

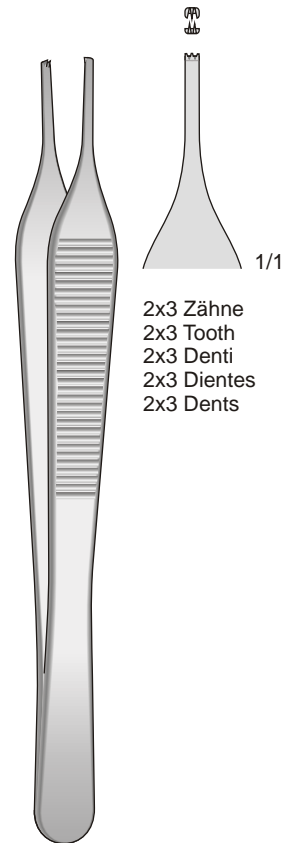

**ADSON  
BD-377  
120 mm**

2x3 Zähne  
2x3 Tooth  
2x3 Denti  
2x3 Dientes  
2x3 Dents

Chirurgische Pinzetten  
Anatomische Pinzetten

Tissue forceps  
Dressing forceps

Pinzette chirurgische  
Pinzette anatomiche

Pinzas quirúrgicas  
Pinzas de disección

Pinces quirúrgicas  
Pinces anatómicas

Standard

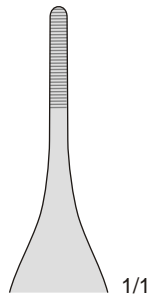

1/1

ADSON  
BD-380  
150 mm

Standard

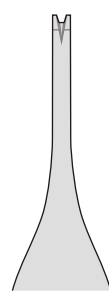

1/1

1x2 Zähne  
1x2 Tooth  
1x2 Denti  
1x2 Dientes  
1x2 Dents

ADSON  
BD-381  
150 mm

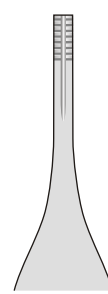

1/1

9x9 Zähne  
9x9 Tooth  
9x9 Denti  
9x9 Dientes  
9x9 Dents

ADSON-BROWN  
BD-382  
150 mm

**Makro  
Absaugkanülen**

**Macro  
Suctions Tubes**

**Macro cannule  
per aspirazione**

**Macro Cànulas  
aspiradoras**

**Macro Canules  
aspiratrices**

Absaugkanülen für Fettleibige - Needles and Tubes for obese patients  
Aghi da infiltrazione per grandi obesi - Cànulas aspiradoras para obeso  
Canules aspiratrices pour obèse

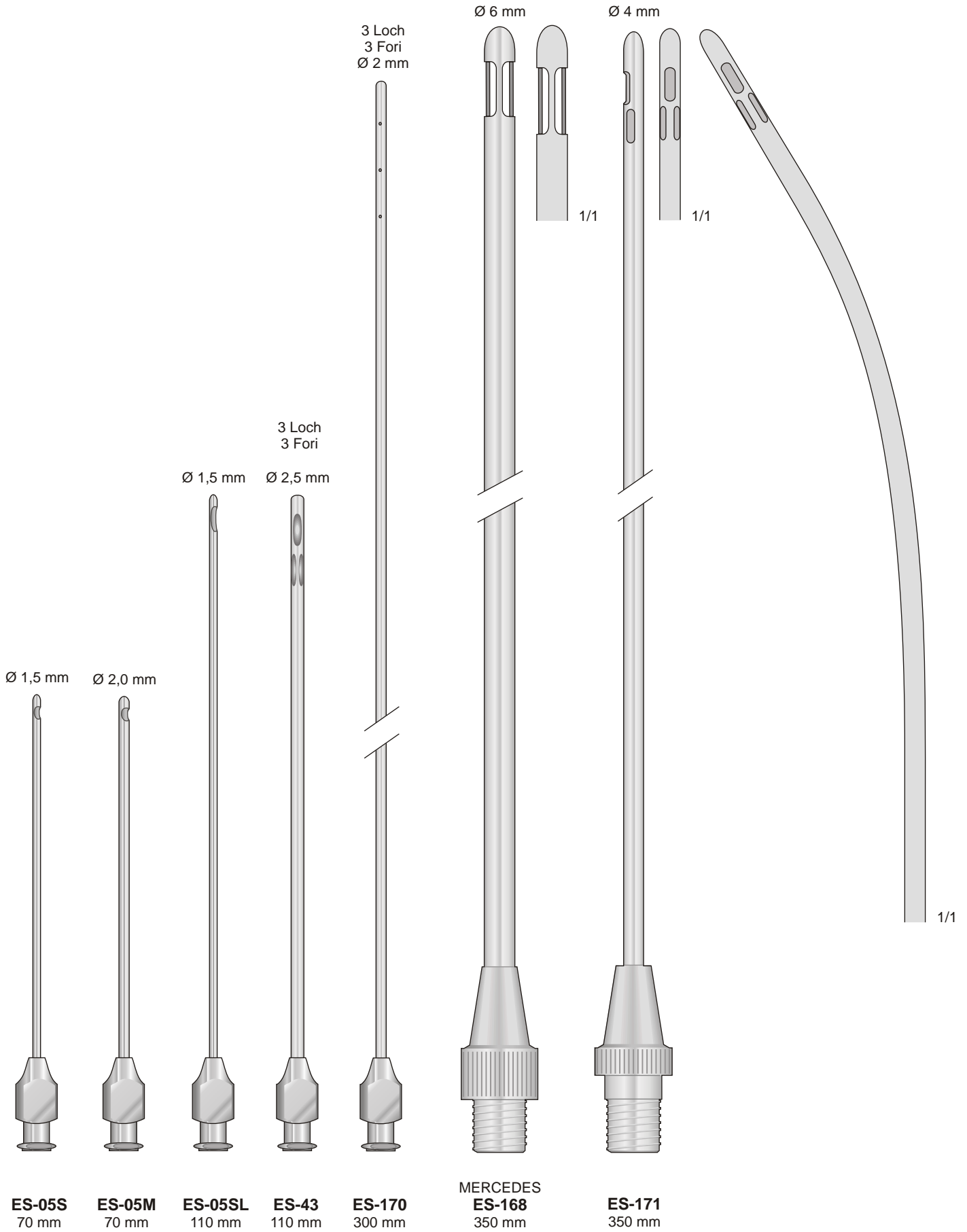

**Makro  
Absaugkanülen**

Ø 2 mm

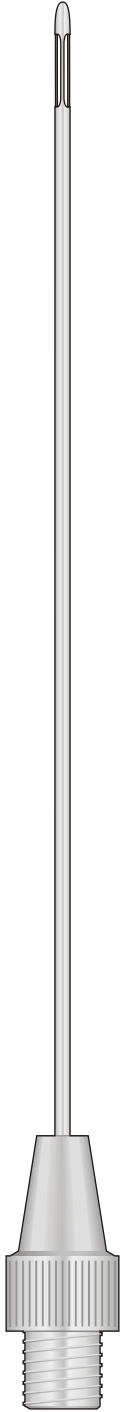

**MERCEDES  
ES-180**  
150 mm

**Macro  
Suctions Tubes**

Ø 2 mm



**MERCEDES  
ES-181**  
250 mm

**Macro cannule  
per aspirazione**

Ø 3 mm

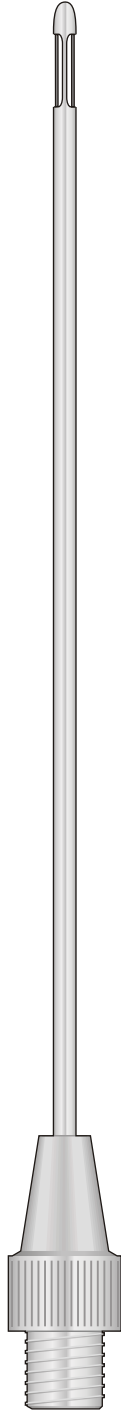

**MERCEDES  
ES-182**  
150 mm

**Macro Cánulas  
aspiradoras**

Ø 3 mm

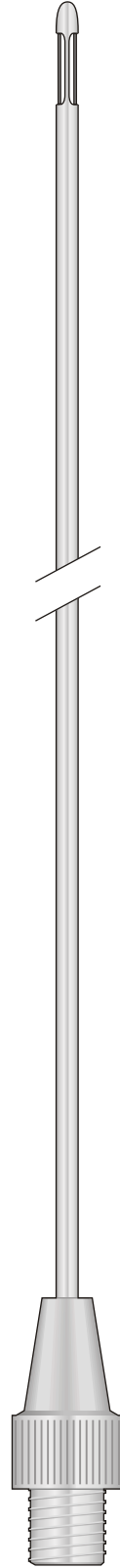

**MERCEDES  
ES-183**  
250 mm

**Macro Canules  
aspiratrices**

Ø 3 mm

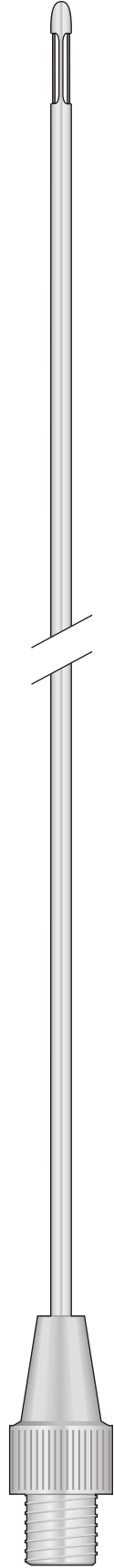

**MERCEDES  
ES-184**  
300 mm

**Makro  
Absaugkanülen**

**Macro  
Suctions Tubes**

**Macro cannule  
per aspirazione**

**Macro Cànulas  
aspiradoras**

**Macro Canules  
aspiratrices**

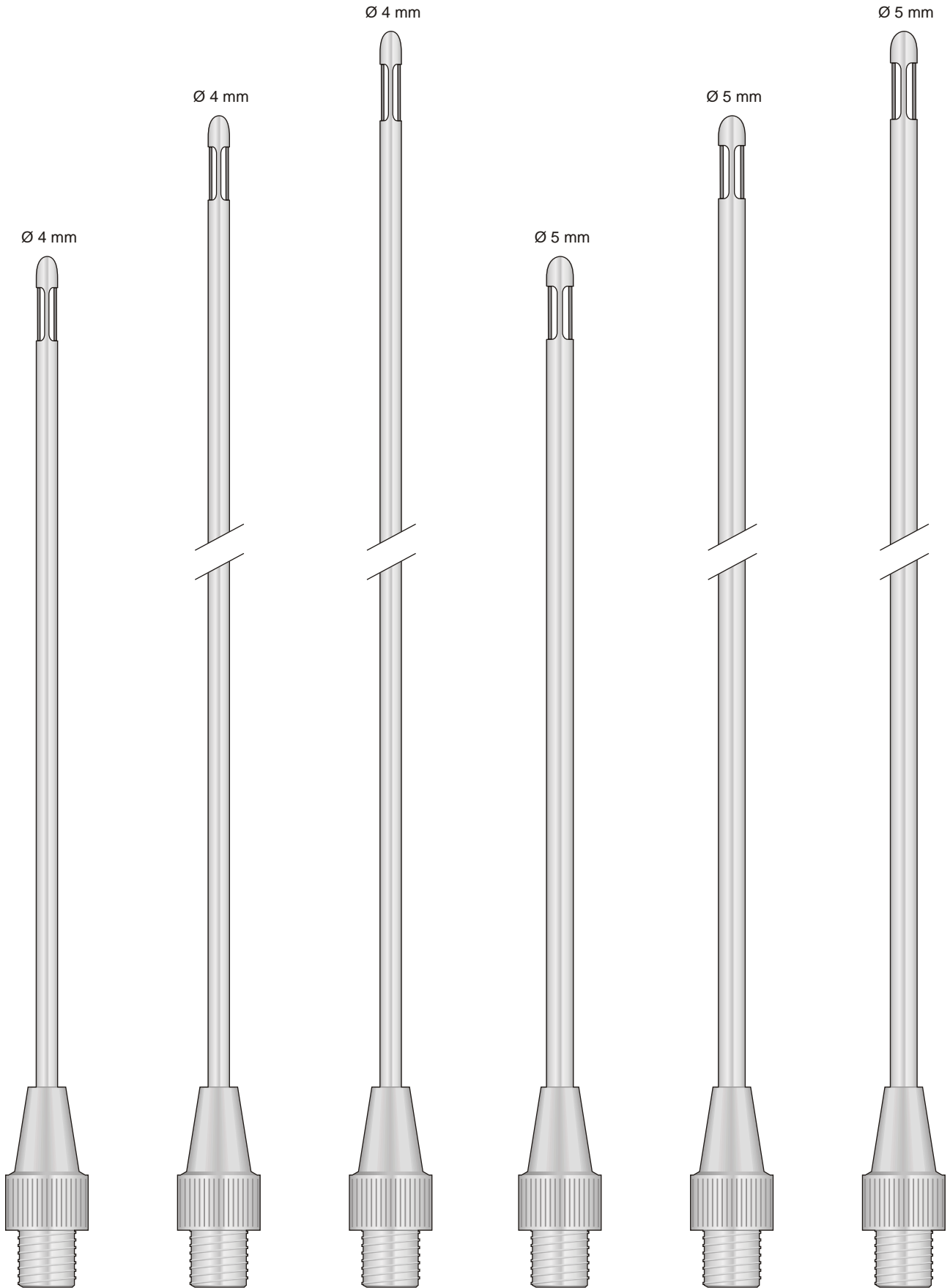

**MERCEDES  
ES-185**  
150 mm

**MERCEDES  
ES-186**  
250 mm

**MERCEDES  
ES-187**  
300 mm

**MERCEDES  
ES-188**  
150 mm

**MERCEDES  
ES-189**  
250 mm

**MERCEDES  
ES-190**  
300 mm



Absaugkanülen

Suctions Tubes

Cannule per aspirazione

Cànulas aspiradoras

Canules aspiratrices

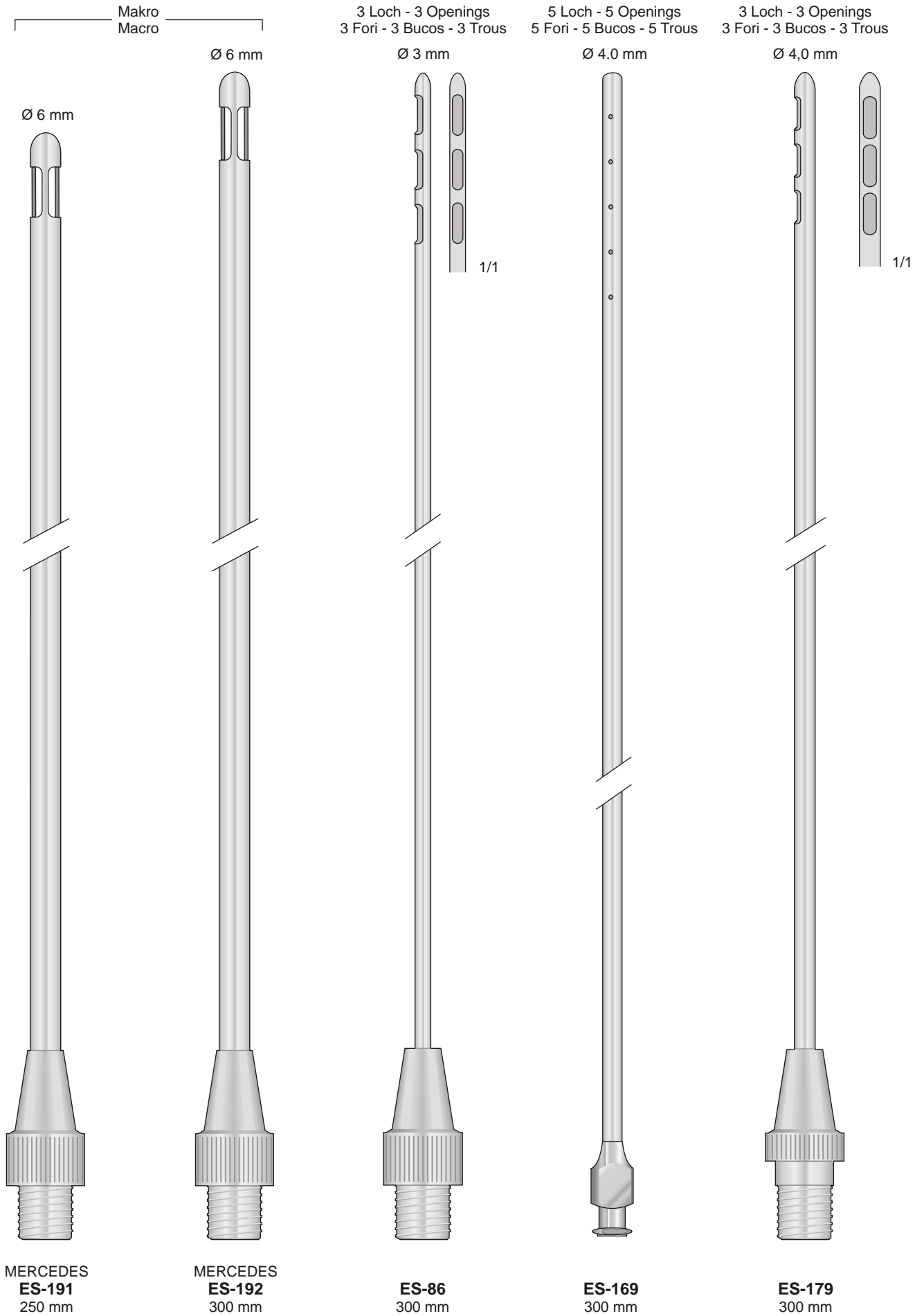

**Makro  
Absaugkanülen**

**Macro  
Suctions Tubes**

**Macro cannule  
per aspirazione**

**Macro Cànulas  
aspiradoras**

**Macro Canules  
aspiratrices**

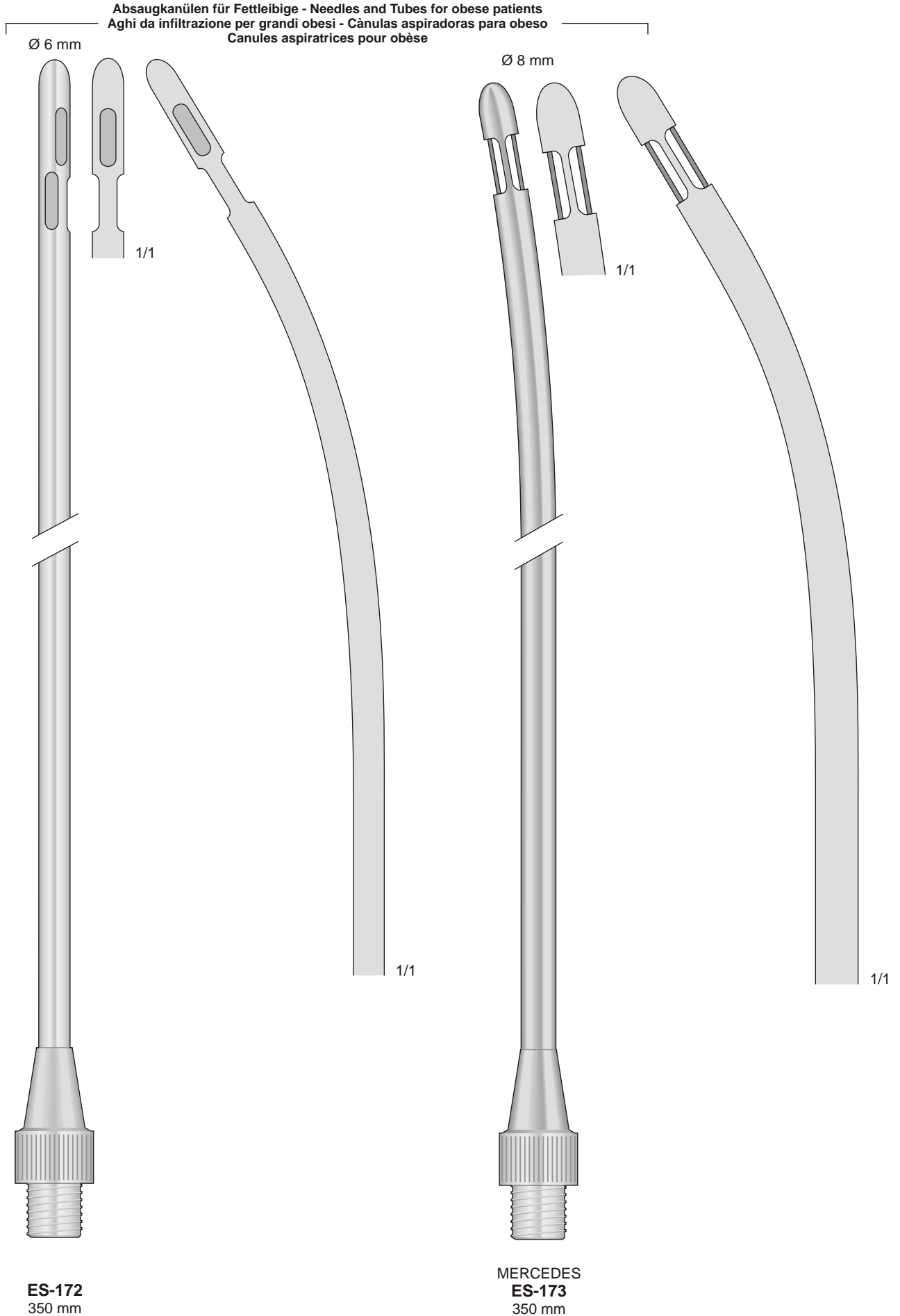

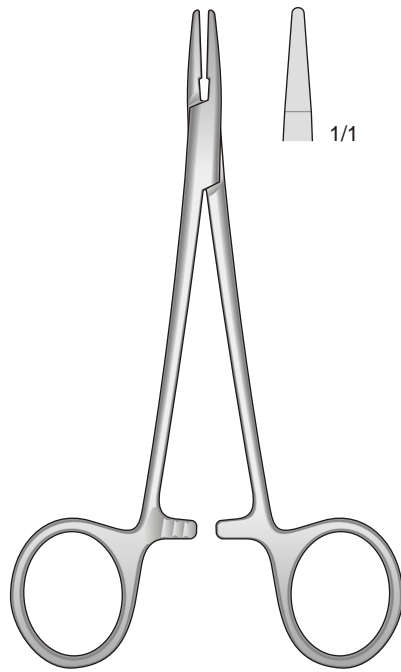

HALSEY  
PH-37  
130 mm

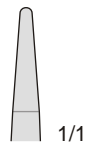

new

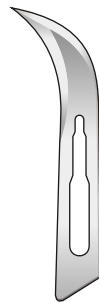

LB-12D



LB-15A



LB-15C

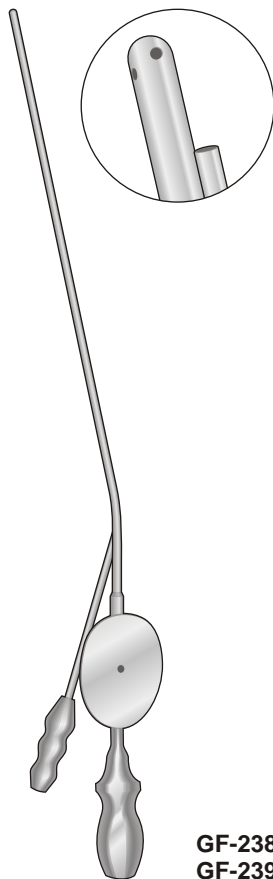

BRACKMANN  
GF-238/GF-239  
155 mm

GF-238 4x5 FR  
GF-239 5x7 FR

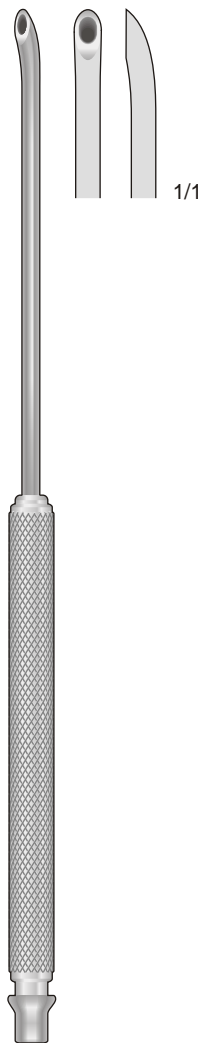

FREER  
GF-79  
185 mm

Raspatorien, Dissektoren  
Raspatories, Dissector  
Raschiatori, Dissettori  
Separadores  
Rugines

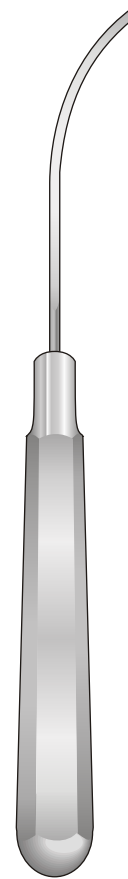

DINGMANN  
DO-265  
155 mm  
# 1-L

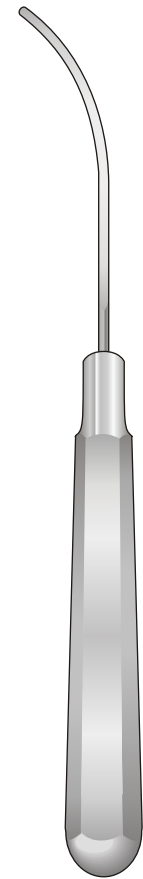

DINGMANN  
DO-266  
155 mm  
# 2-R

Dermatome komplett mit 1 auswechselbarer Klinge und 2 Spannplatten  
 Dermatome complete with 1 interchangeable blade and 2 skin plates  
 Dermatomo a mano, con una lama intercambiabile, completo di 2 placche per stendere la pelle  
 Dermatomo completo, con 1 hoja intercambiabile y 2 placas para extender la piel  
 Dermatome avec 1 lame interchangeable et 2 plaques pour tendre la peau

Einstellbar von 0,1 bis 3,0 mm  
 Adjustable from 0,1 to 3,0 mm  
 Regolazione da 0,1 a 3,0 mm  
 Regulable de 0,1 hasta 3,0 mm  
 Réglable en épaisseur de 0,1 à 3,0 mm

Einstellbar von 0,1 bis 4,0 mm  
 Adjustable from 0,1 to 4,0 mm  
 Regolazione da 0,1 a 4,0 mm  
 Regulable de 0,1 hasta 4,0 mm  
 Réglable en épaisseur de 0,1 à 4,0 mm

Für handelsübliche Rasierklingen  
 For usual razor blades  
 Per lamette standard  
 Para hojas de afeitar usuales  
 Pour lames de rasoir modèle standard

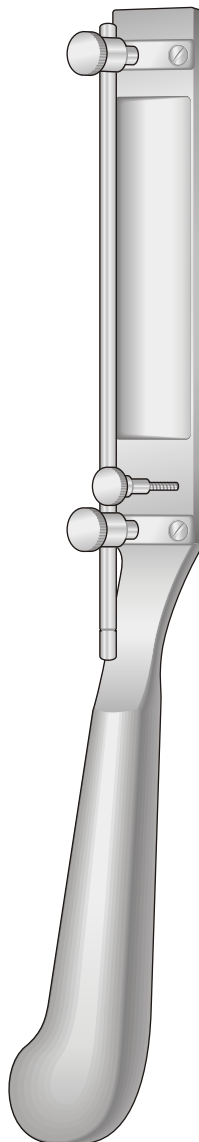

Ersatzklinge, allein  
 Spare Blade only  
 Lama di ricambio sola  
 Hoja de repuesto  
 Lame de rechange, seule

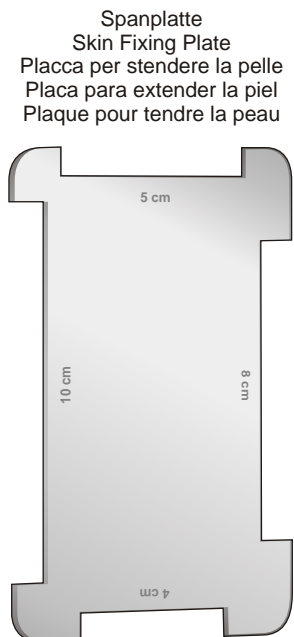

**SCHINK  
DE-10**

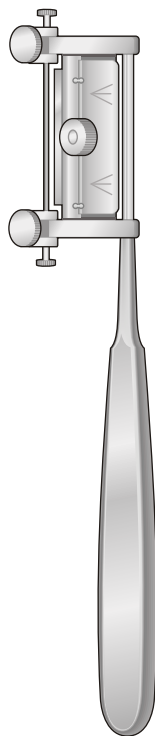

**SILVER  
DE-11  
190 mm**

Ersatzklinge, allein  
 Spare Blade only  
 Lama di ricambio sola  
 Hoja de repuesto  
 Lame de rechange, seule

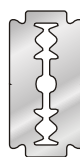

**SILVER  
DE-12  
43 mm**

Dermatome

Dermatomes

Dermatomi

Dermátomos

Dermatomes

Dermatome komplett mit 1 auswechselbarer Klinge und 2 Spannplatten  
 Dermatome complete with 1 interchangeable blade and 2 skin plates

Dermatomo a mano, con una lama intercambiabile, completo di 2 placche per stendere la pelle  
 Dermatomo completo, con 1 hoja intercambiabile y 2 placas para extender la piel  
 Dermatome avec 1 lame interchangeable et 2 plaques pour tendre la peau

Einstellbar von 0,1 bis 1,5 mm  
 Adjustable from 0,1 to 1,5 mm  
 Regolazione da 0,1 a 1,5 mm  
 Regulable de 0,1 hasta 1,5 mm  
 Réglable en épaisseur de 0,1 à 1,5 mm

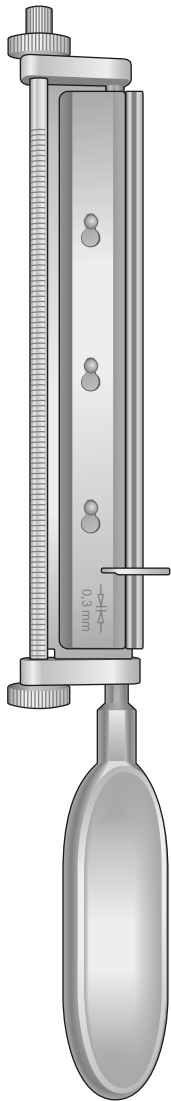

**WATSON  
DE-15**  
300 mm

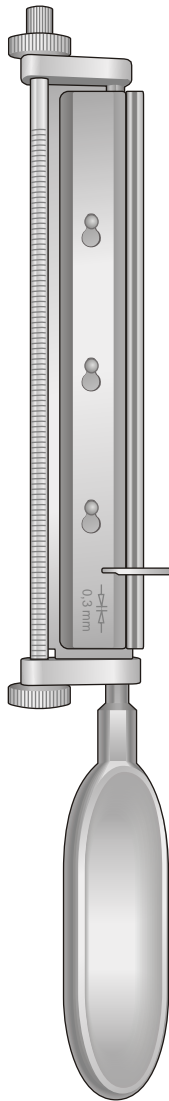

**COBBETT  
DE-16**  
300 mm

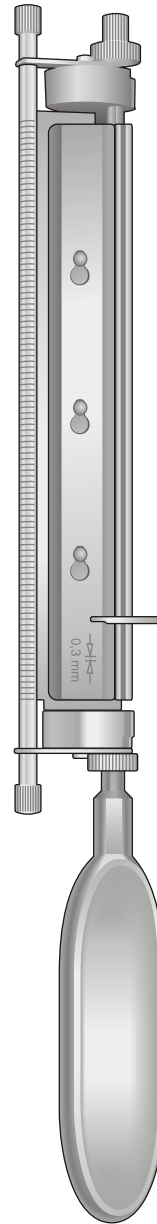

**HUMBY  
DE-17**  
320 mm

Ersatzklinge, allein  
 Spare Blade only  
 Lama di ricambio sola  
 Hoja de repuesto  
 Lame de rechange, seule

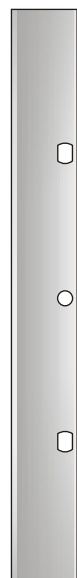

**HUMBY  
DE-18**  
157 mm

450 gr.

Ferrozell-Hämmer  
Hammer in Ferrozell  
Martello in Ferrozell  
Martillo en Ferrozell  
Marteau dans Ferrozell

Ø 50 mm



**FL-129**  
260 mm

Ø 4.0 mm

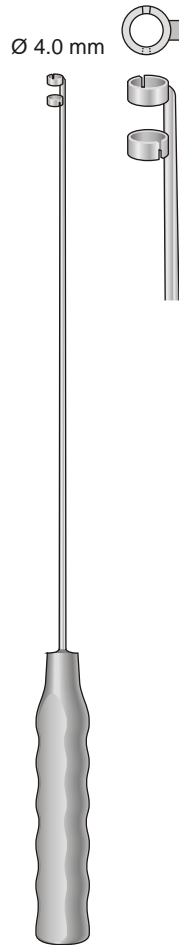

**FISCHER**  
**FO-235**  
310 mm

Kopfhautklemme  
Scalp Haemostatic forceps  
Pinza emostatica per il cuoio capelluto  
Pinza hemostáticas para pericraneo

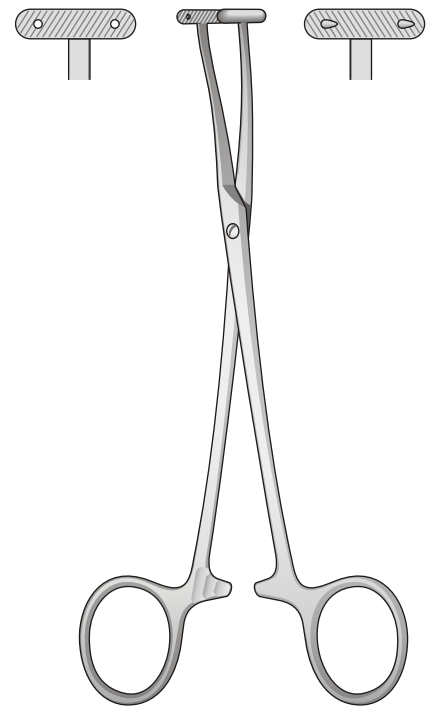

**DE MARTEL**  
**FB-119**  
145 mm

Kanülenreinigungs  
bürsten

Cleaning brush  
for tubes

Scovolini per  
pulizia cannule

Cepillo para  
limpiar cánulas

Brosse de nettoyage  
pour canules

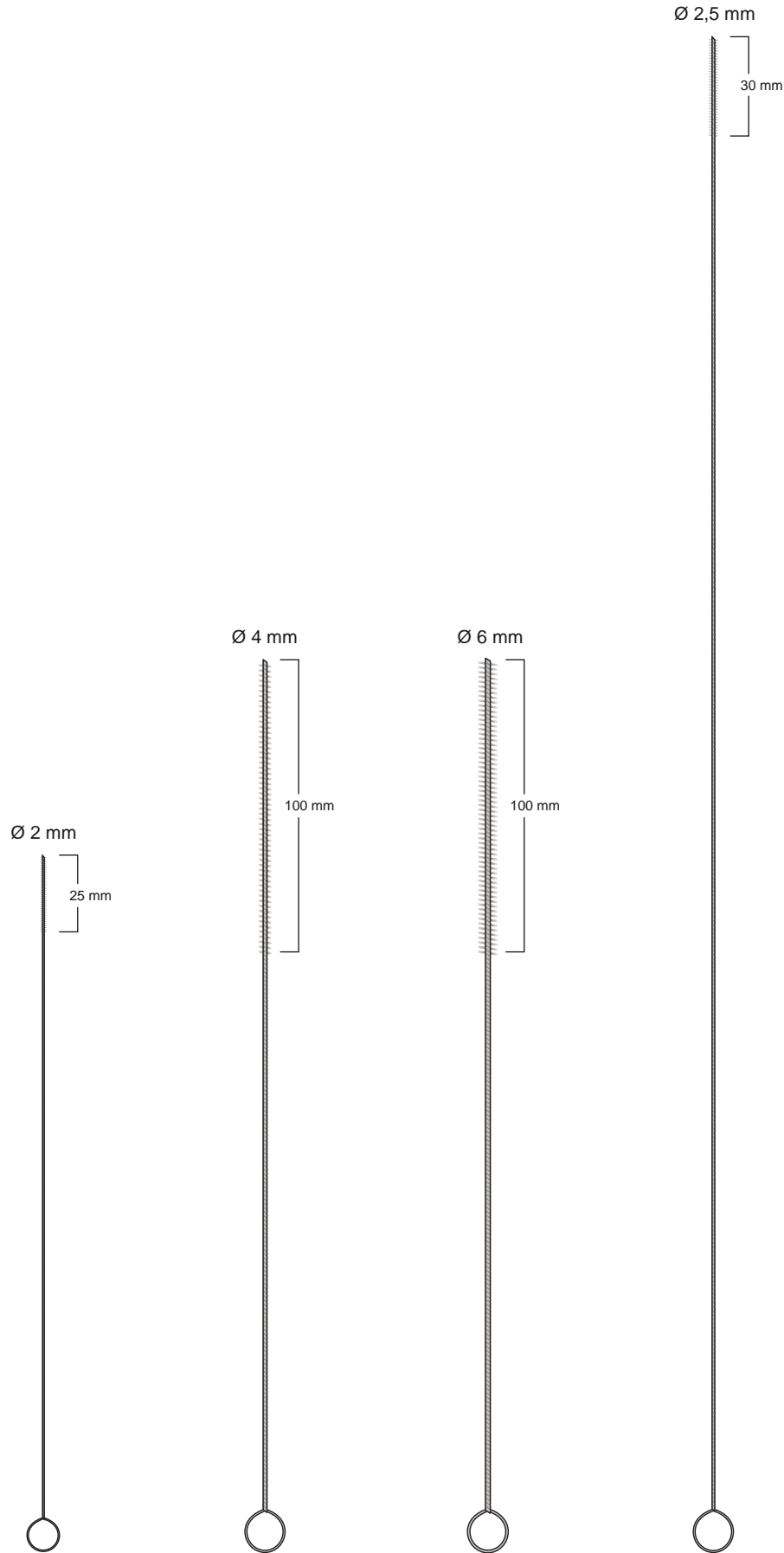

**GF-182**  
215 mm

**GF-183**  
300 mm

**GF-185**  
300 mm

**GF-186**  
500 mm

# Super Cut

Mit einer Schneide gezahnt  
 With one blade serrated  
 Con una lama dentellata  
 Con una hoja dentada  
 Avec une lame dentèle

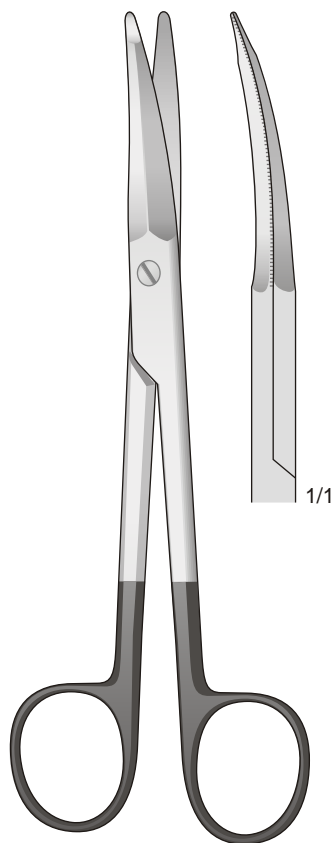

REES-FACE-LIFT  
**FM-304**  
 150 mm

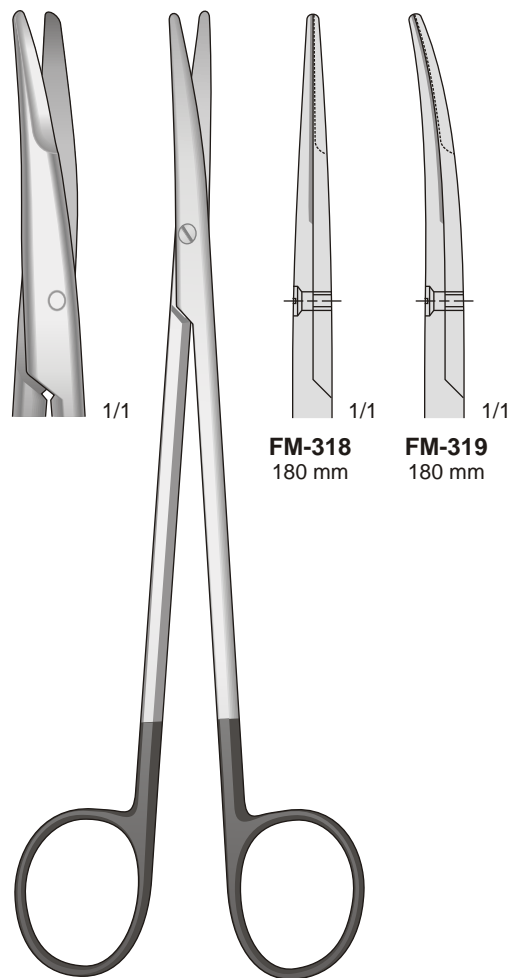

METZENBAUM  
**FM-318/FM-319**  
 180 mm



# Super Cut

Mit einer Schneide gezahnt  
With one blade serrated  
Con una lama dentellata  
Con una hoja dentada  
Avec une lame dentèle

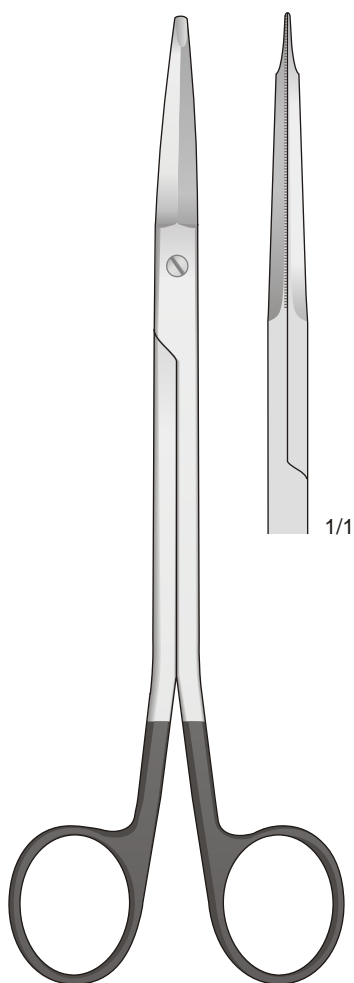

FREEMANN-KAYE  
**FM-332**  
180 mm

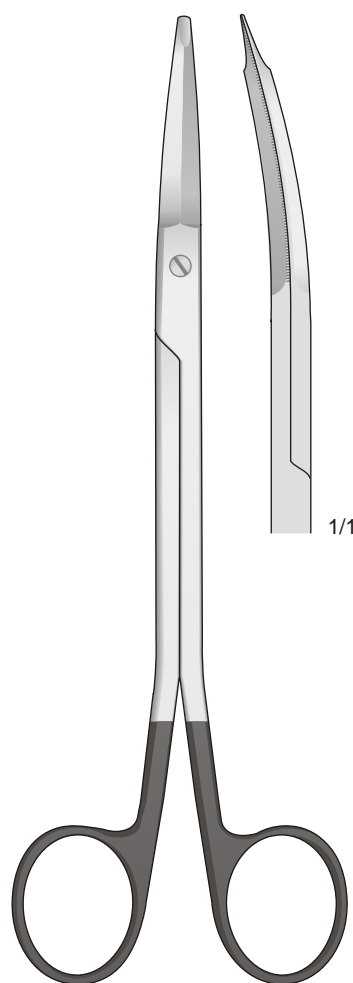

FREEMANN-KAYE  
**FM-333**  
180 mm

## Vergoldet Super Cut

Mit einer Schneide gezahnt  
With one blade serrated  
Con una lama dentellata  
Con una hoja dentada  
Avec une lame dentèle

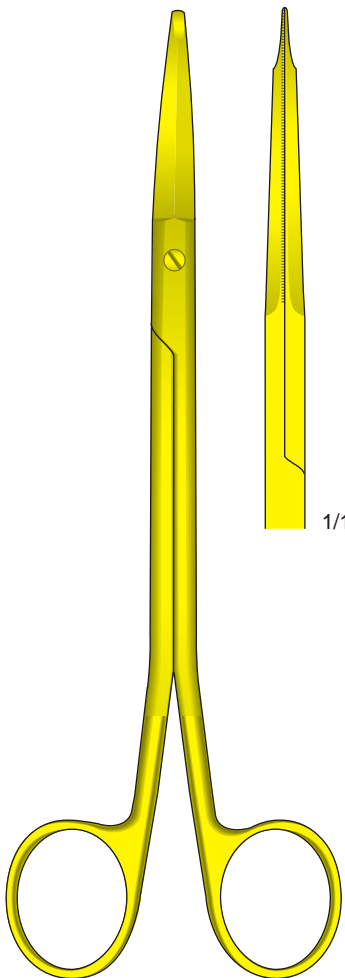

FREEMAN KAYE  
**FM-332G**  
180 mm

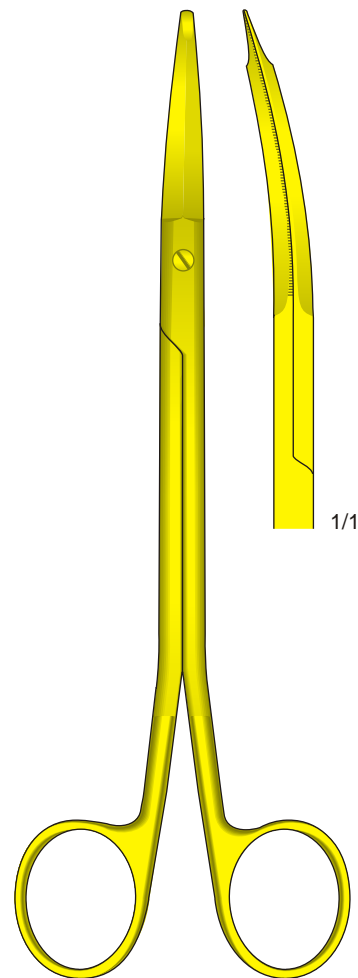

FREEMAN KAYE  
**FM-333G**  
180 mm

# Vergoldet Super Cut

Mit einer Schneide gezahnt  
With one blade serrated  
Con una lama dentellata  
Con una hoja dentada  
Avec une lame dentèle

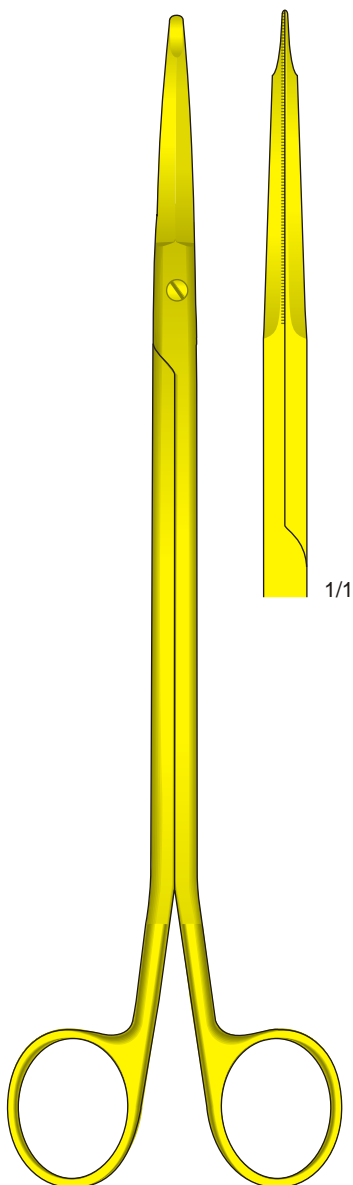

GORNEY  
**FM-313G**  
230 mm

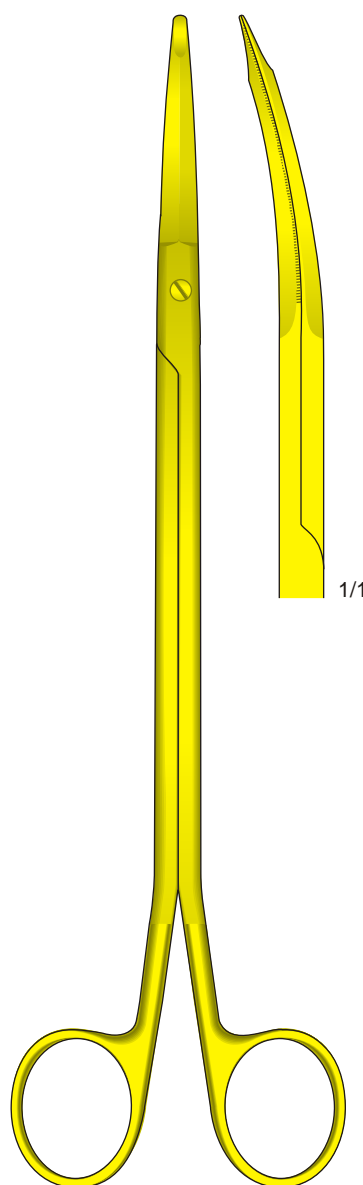

GORNEY  
**FM-314G**  
230 mm

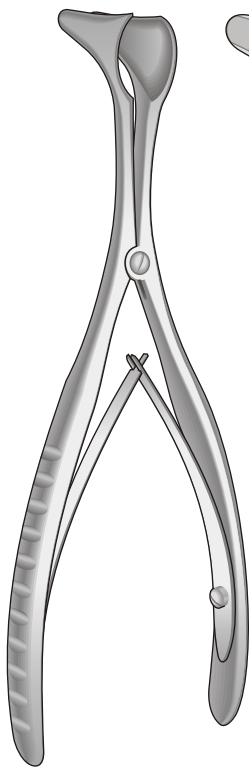

HARTMANN-HALLE  
**OM-108M**  
150 mm

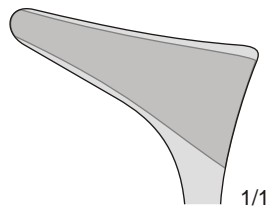

**OM-108M**  
Fig. 2

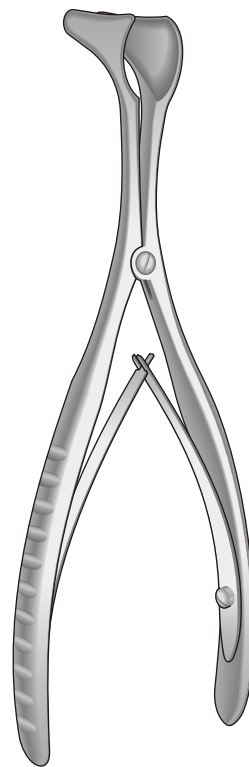

HARTMANN-HALLE  
**OM-106/OM-109**  
150 mm

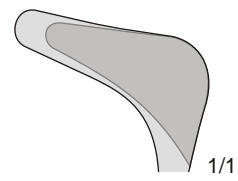

**OM-106**  
Fig. 00

Kinder  
Children  
Bambini  
Niños  
Enfants

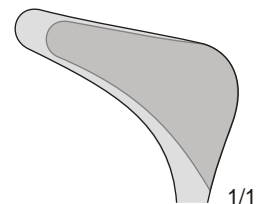

**OM-107**  
27 mm  
Fig. 1

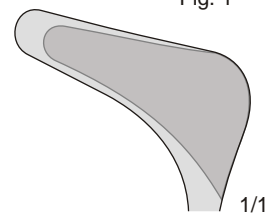

**OM-108**  
31 mm  
Fig. 2

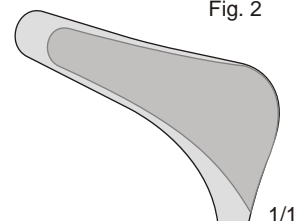

**OM-109**  
35 mm  
Fig. 3

**ES-150**  
 Komplettsset mit 3 Stück - Set complete with 3 pieces  
 Set completo con 3 pezzi - Set completo con 3 piezas  
 Set complete avec 3 pièces  
**ES-151 + ES-152 + ES-153**

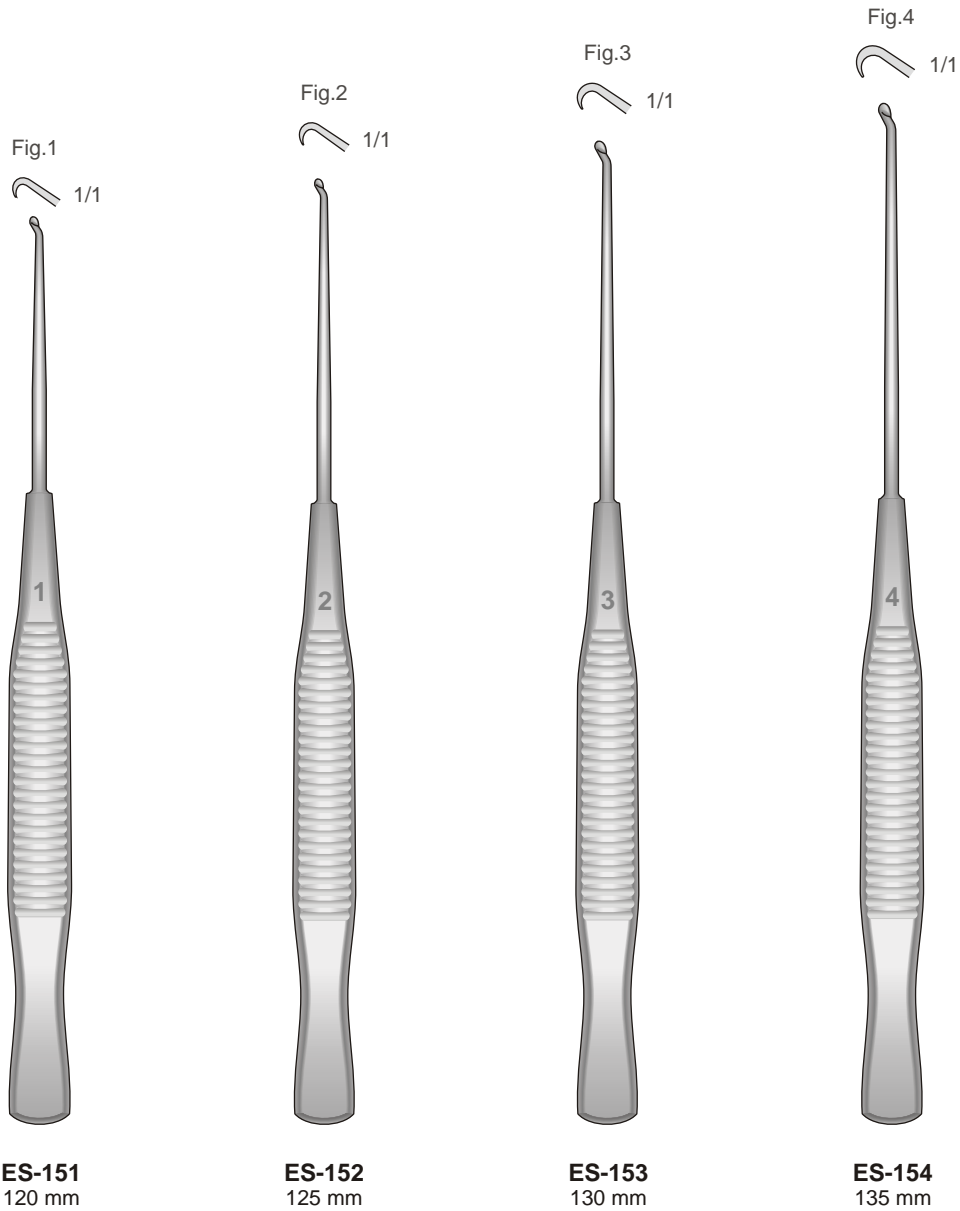

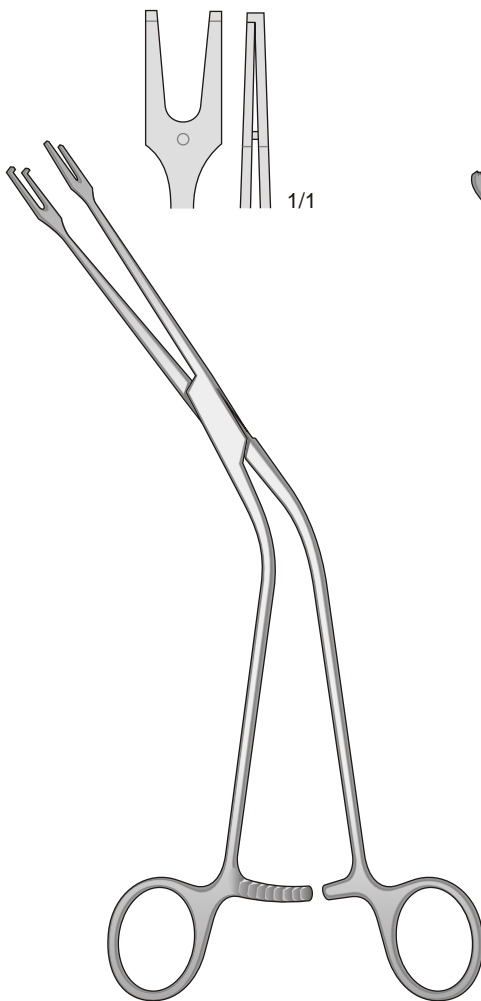

MILLIN  
FB-227  
245 mm

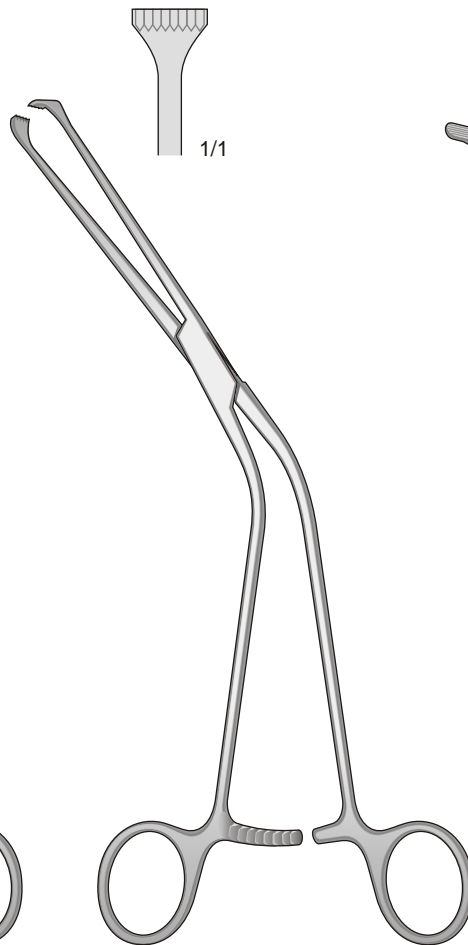

MILLIN  
FB-228  
220 mm

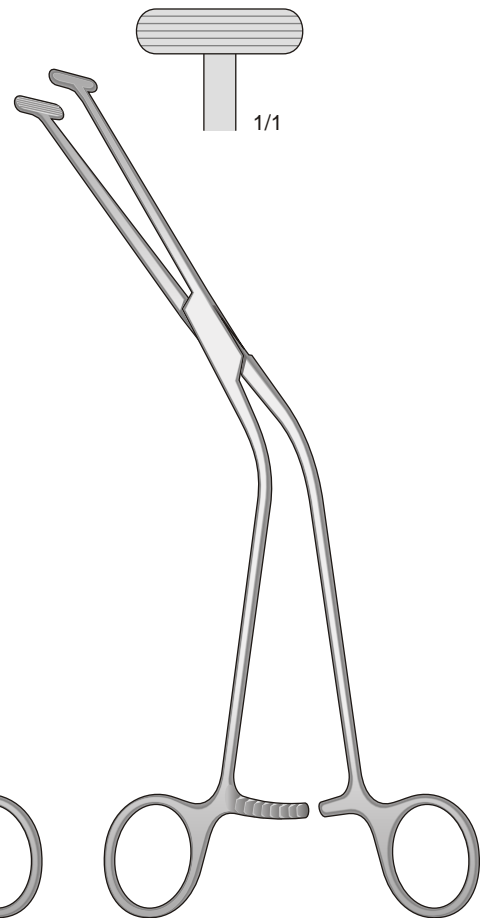

MILLIN  
FB-229  
245 mm

Atraumatische - Atraumatic  
Atraumatiche - Atraumáticas  
Atraumatiques

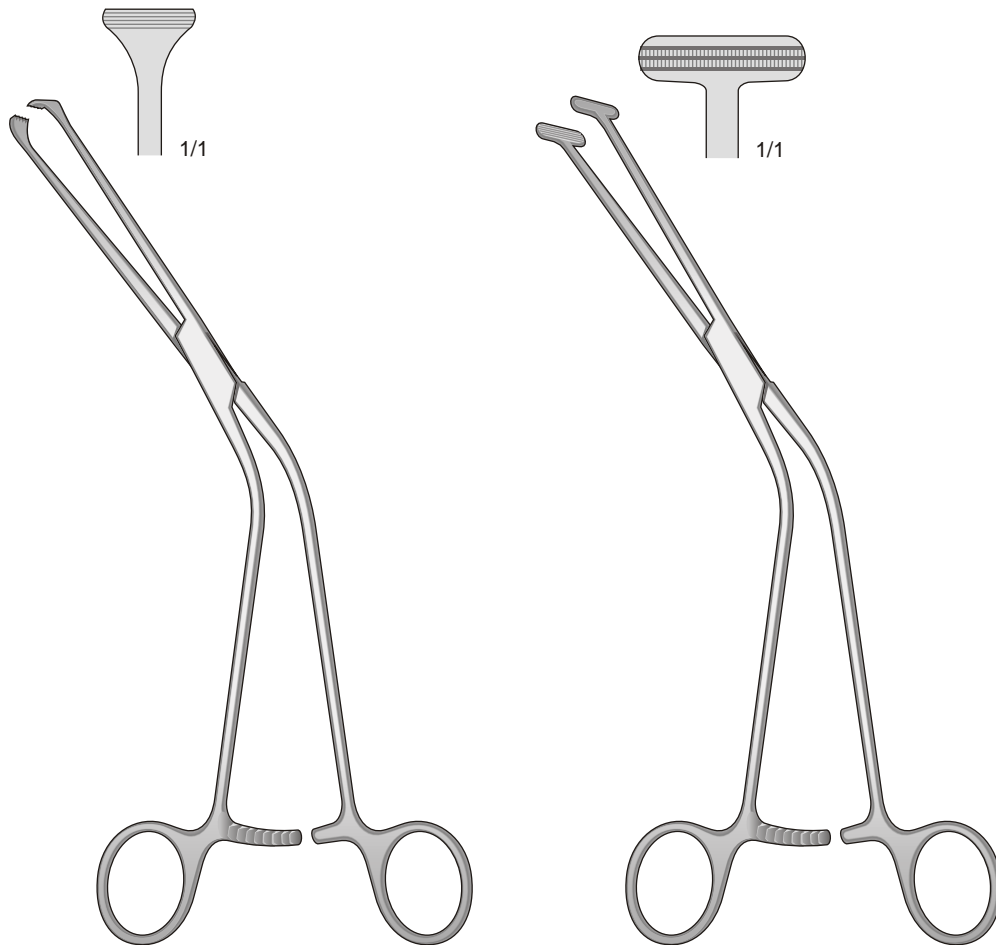

MILLIN  
FB-230  
220 mm

MILLIN  
FB-231  
245 mm

Alogena



HT-250S



Fiberglas-Lichtkabel  
Fiber Optic Cable  
Cavo a fibre ottiche

HT-131K Ø 3,5 mm - 230 cm  
HT-134K Ø 4,8 mm - 300 cm

Xenon



HT-180X

Xenon



HT-300X



Fiberglas-Lichtkabel  
Fiber Optic Cable  
Cavo a fibre ottiche  
per alte temperature

HT-1331K Ø 3,5 mm - 230 cm  
HT-1332K Ø 3,5 mm - 300 cm



Mit Absaugkanülen  
With Suction Tube  
Con aspirazione  
Con aspiración  
Avec aspiration

8,0 mm

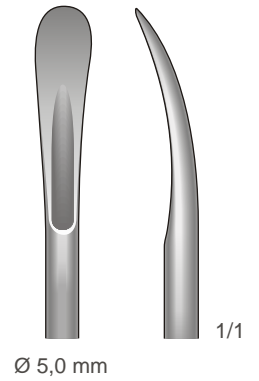

Double ended  
Breast Retractor

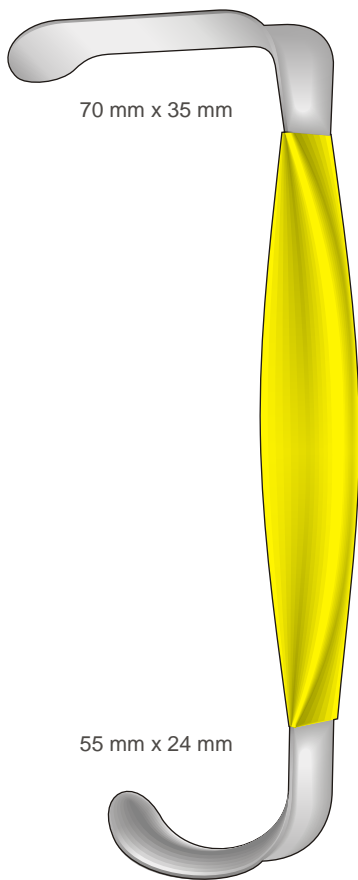

70 mm x 35 mm

55 mm x 24 mm

**ES-145**  
230 mm

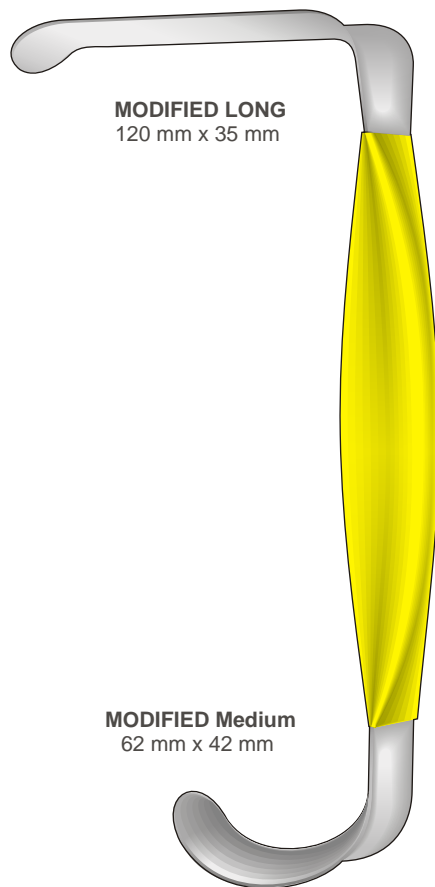

**MODIFIED LONG**  
120 mm x 35 mm

**MODIFIED Medium**  
62 mm x 42 mm

**ES-145M**  
230 mm



**ES-130**  
270 mm

Raccordo per  
due siringhe

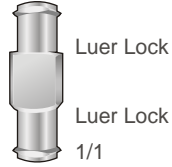

**ES-03**  
21 mm

Raccordo  
Luer Lock

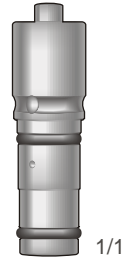

**ES-306**  
34 mm



**ES-301**  
160 mm



**ES-302**  
155 mm



**ES-303**  
155 mm

Kanüle  
für Liposculture

Cannula  
for Liposculture

Cannule da  
Liposcultura

Cânulas de  
Liposcultura

Canules pour  
liposculture

Luer-Lock Cannule

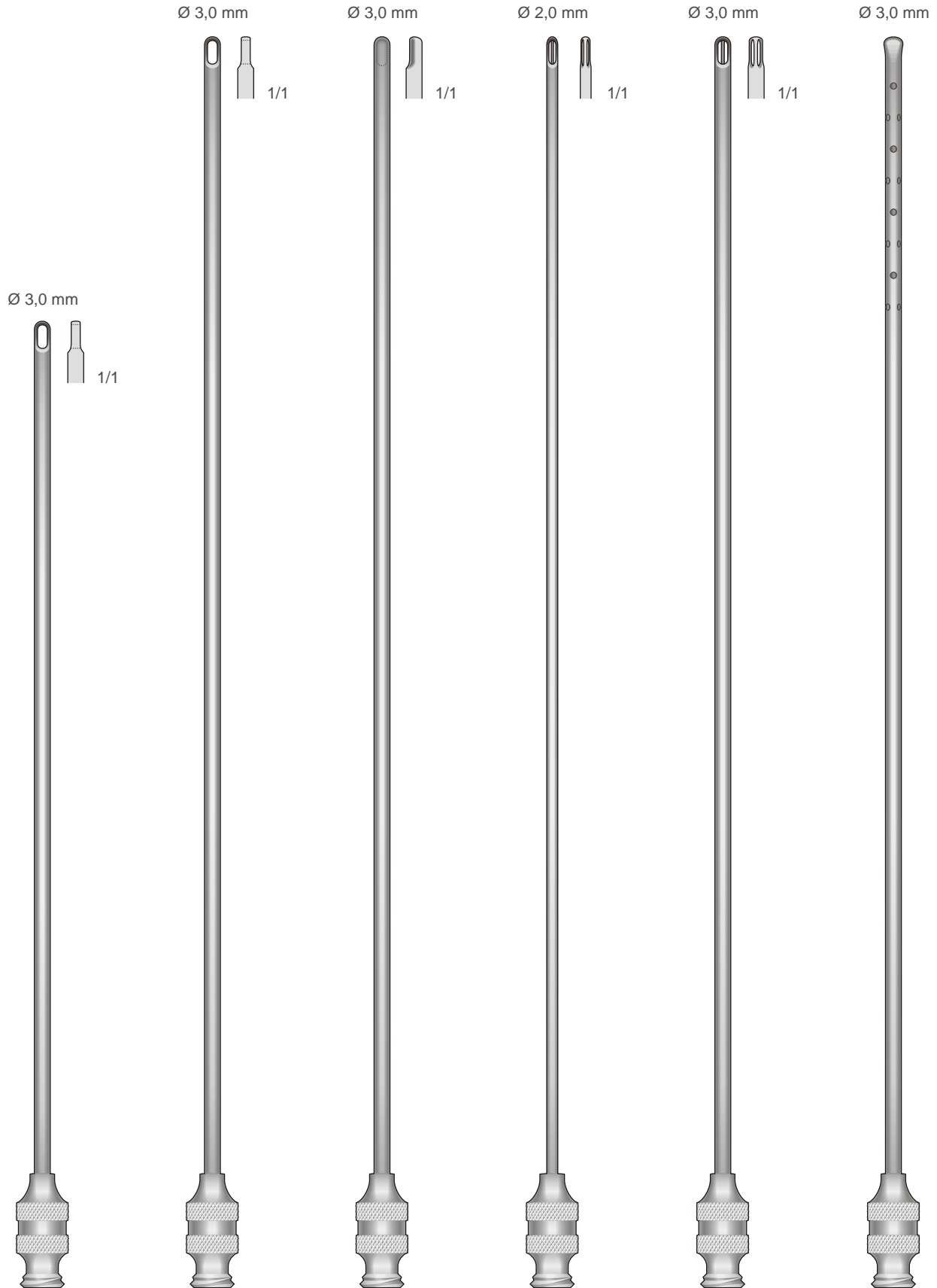

**ES-311**  
150 mm

**ES-312**  
200 mm

**ES-313**  
200 mm

**ES-314**  
200 mm

**ES-315**  
200 mm

**ES-316**  
200 mm

**Kanüle für Liposculture**  
**Luer-Lock Cannule**

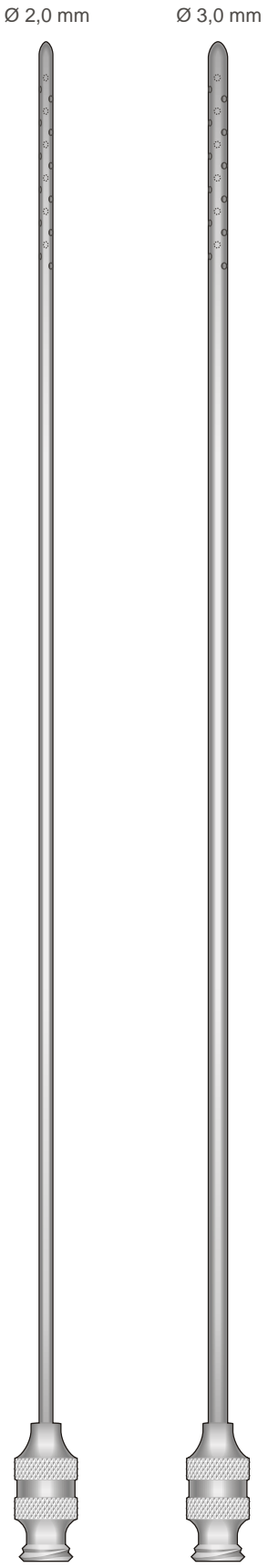

**ES-317** 200 mm  
**ES-318** 200 mm

**Cannula for Liposculture**

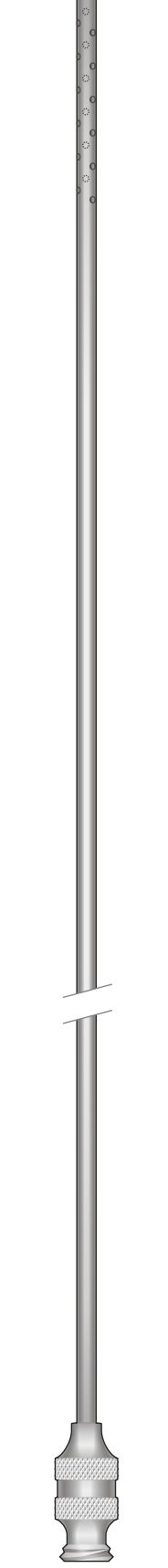

**ES-319** 300 mm

**Cannule da Liposcultura**

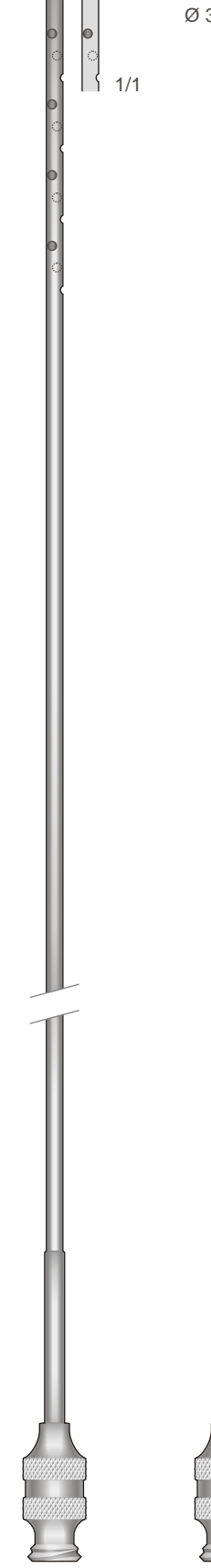

**ES-320** 250 mm

**Cànulas de Liposcultura**

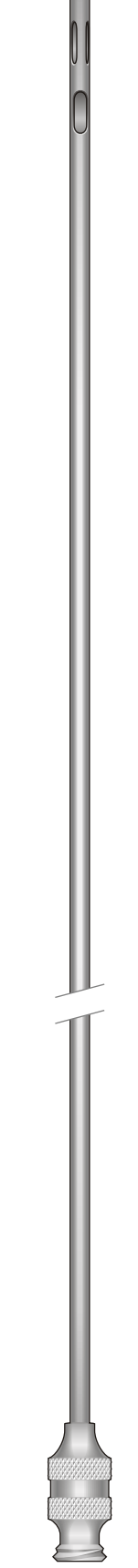

**ES-322** 300 mm

**Canules pour liposculture**



**ES-323** 250 mm

Infiltration Kanüle

Infiltration Cannula

Cannule da infiltrazione

Cánulas de infiltración

Canules pour infiltration

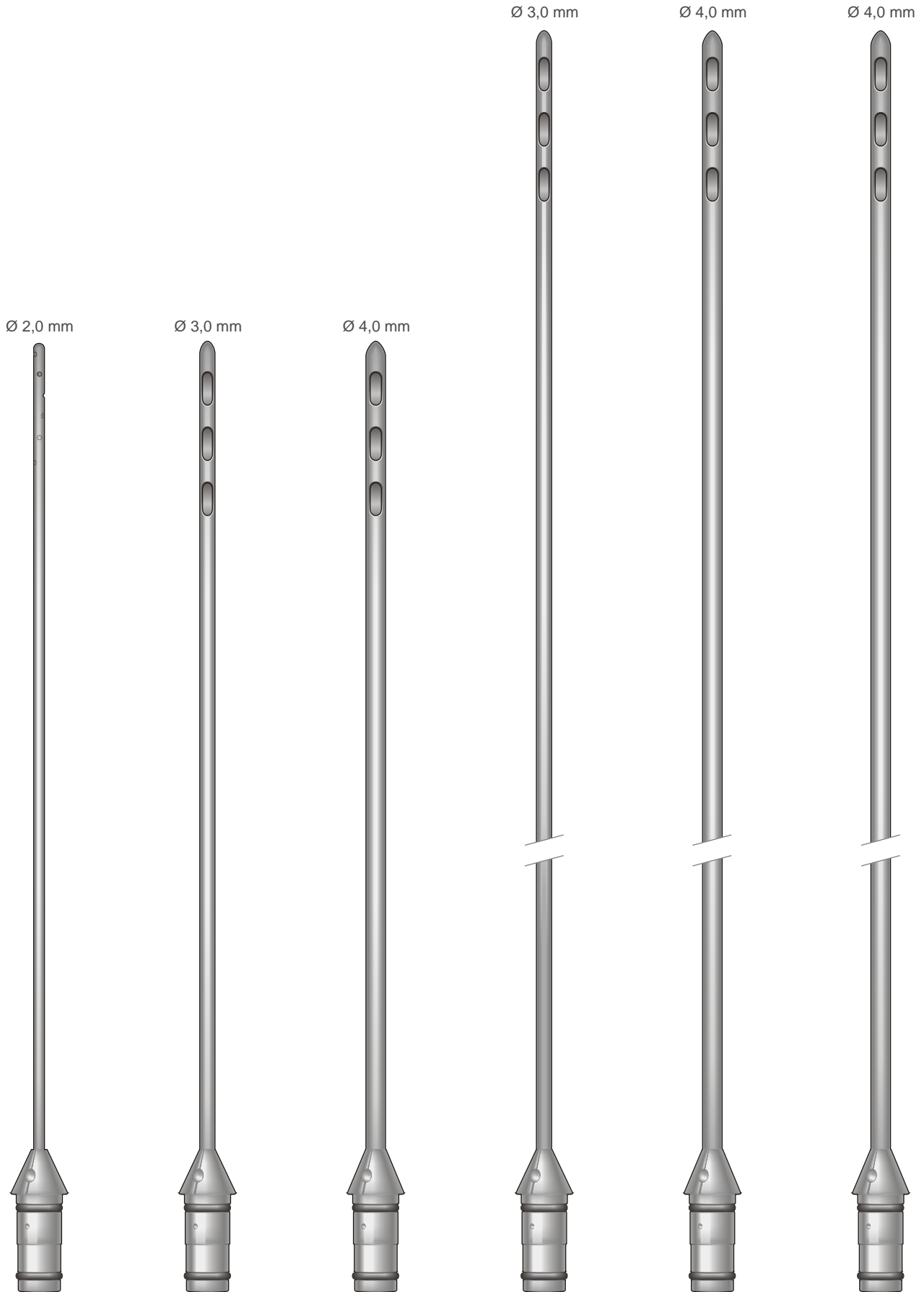

**ES-331**  
150 mm

**ES-339**  
150 mm

**ES-340**  
150 mm

**ES-341**  
250 mm

**ES-342**  
250 mm

**ES-343**  
300 mm

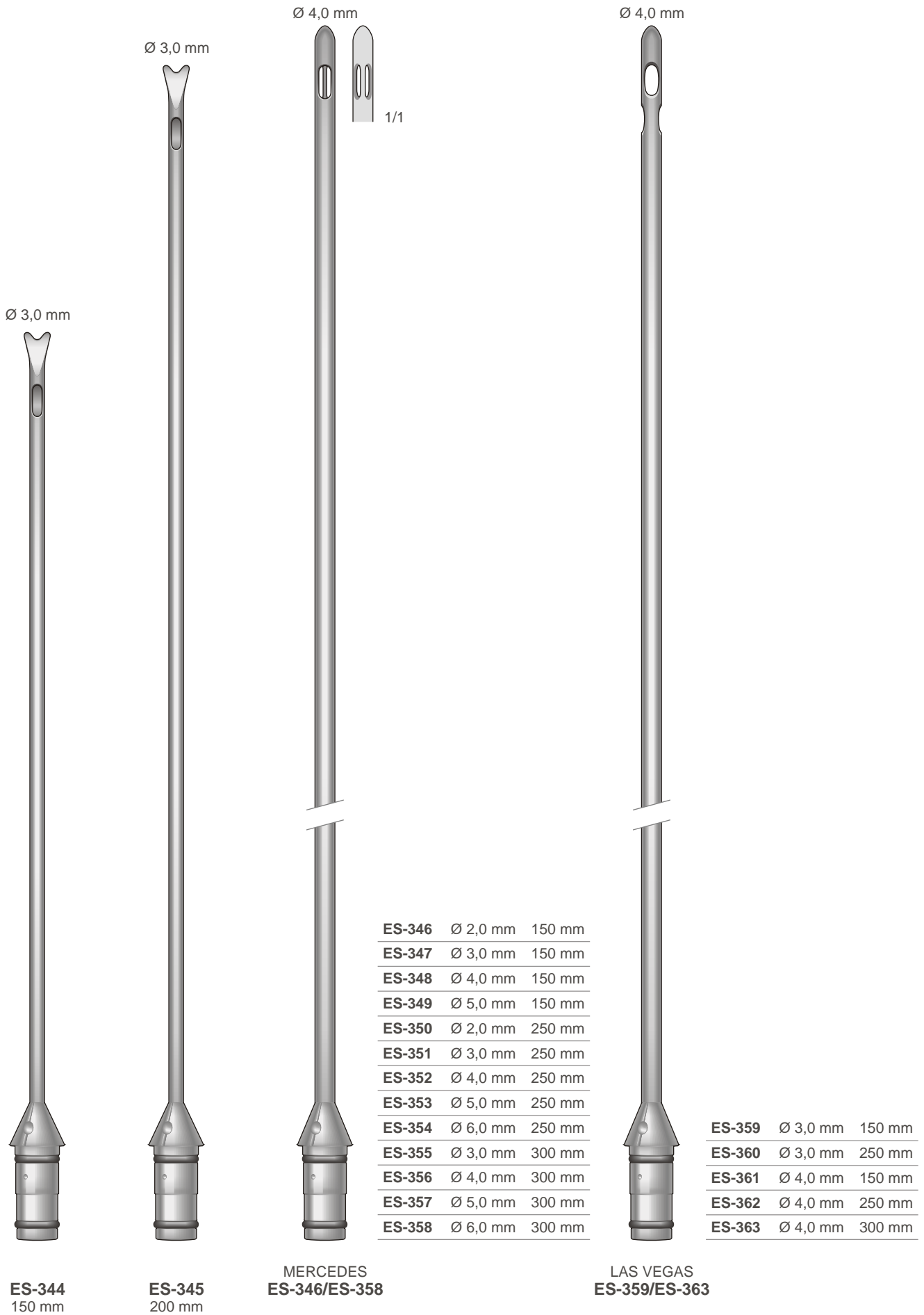

Ø 3,0 mm

Ø 3,0 mm

Ø 4,0 mm

Ø 4,0 mm

1/1

<b>ES-346</b>	Ø 2,0 mm	150 mm
<b>ES-347</b>	Ø 3,0 mm	150 mm
<b>ES-348</b>	Ø 4,0 mm	150 mm
<b>ES-349</b>	Ø 5,0 mm	150 mm
<b>ES-350</b>	Ø 2,0 mm	250 mm
<b>ES-351</b>	Ø 3,0 mm	250 mm
<b>ES-352</b>	Ø 4,0 mm	250 mm
<b>ES-353</b>	Ø 5,0 mm	250 mm
<b>ES-354</b>	Ø 6,0 mm	250 mm
<b>ES-355</b>	Ø 3,0 mm	300 mm
<b>ES-356</b>	Ø 4,0 mm	300 mm
<b>ES-357</b>	Ø 5,0 mm	300 mm
<b>ES-358</b>	Ø 6,0 mm	300 mm
<b>ES-359</b>	Ø 3,0 mm	150 mm
<b>ES-360</b>	Ø 3,0 mm	250 mm
<b>ES-361</b>	Ø 4,0 mm	150 mm
<b>ES-362</b>	Ø 4,0 mm	250 mm
<b>ES-363</b>	Ø 4,0 mm	300 mm

**ES-344**  
150 mm

**ES-345**  
200 mm

**MERCEDES**  
**ES-346/ES-358**

**LAS VEGAS**  
**ES-359/ES-363**

Infiltration Kanüle

Infiltration Cannula

Cannule da infiltrazione

Cánulas de infiltración

Canules pour infiltration

Ø 3,0 mm

Ø 3,0 mm

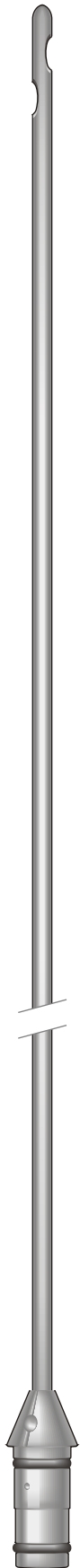

**ES-364**  
250 mm

**ES-365/ES-366**

<b>ES-365</b>	Ø 3,0 mm	150 mm
<b>ES-366</b>	Ø 3,0 mm	200 mm

Pinza per rimozione punti metallici

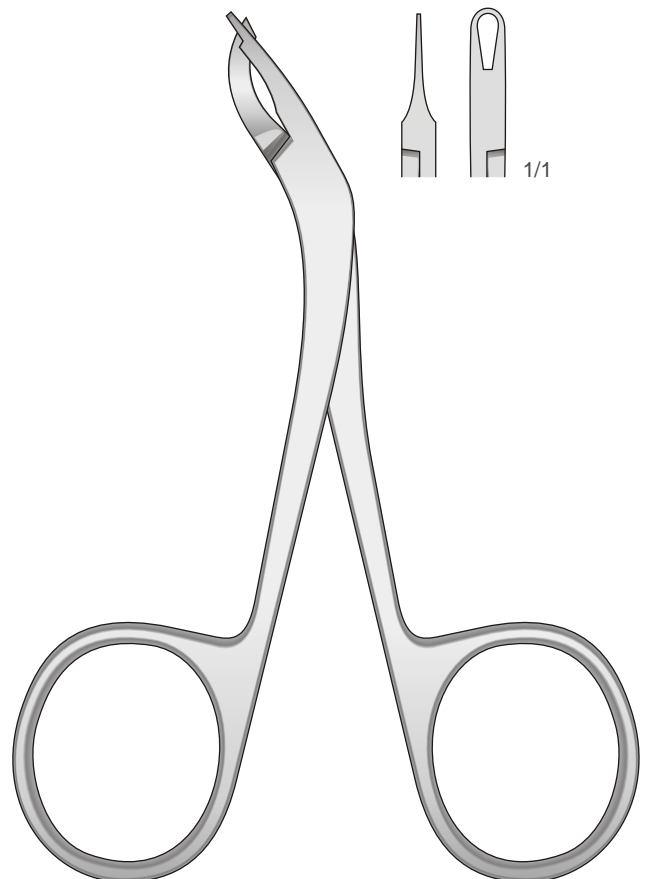

**BF-64**  
115 mm

Nummernverzeichnis		Alfanumerical Index		Indice alfanumérico		Index alfanumerique		Indice alfanumerico	
Art.	Art.	Art.	Art.	Art.	Art.	Art.	Art.	Art.	Art.
BD-253	34	DO-115	25	ES-163	10	ES-360	60	LB-12D	41
BD-347	31	DO-116	25	ES-164	13	ES-361	60	LB-15A	41
BD-348	31	DO-135	25	ES-165	13	ES-362	60	LB-15C	41
BD-349	31	DO-207	10	ES-168	36	ES-363	60		
BD-350	11	DO-208	28	ES-169	39	ES-371	61	OM-09	11
BD-351	32	DO-209	28	ES-170	36			OM-106	50
BD-352	32	DO-210	28	ES-171	36	FB-119	44	OM-107	50
BD-353	32	DO-219	24	ES-172	40	FB-227	52	OM-108	50
BD-354	32	DO-228	24	ES-173	40	FB-228	52	OM-108M	50
BD-355	32	DO-229	24	ES-179	39	FB-229	52	OM-109	50
BD-356	32	DO-238	24	ES-180	37	FB-230	53	OM-190	16
BD-358	30	DO-239	24	ES-181	37	FB-231	53	OM-191	16
BD-359	30	DO-253	27	ES-182	37			OM-192	16
BD-360	30	DO-254	26	ES-183	37	FG-121	23	OM-192L	16
BD-361	30	DO-255	26	ES-184	37	FG-163	22	OM-193	17
BD-362	30	DO-256	26	ES-185	38	FG-192	21	OM-194	17
BD-363	30	DO-265	41	ES-186	38	FG-193	21	OM-195	17
BD-364	31	DO-266	41	ES-187	38	FG-194	21	OM-195L	17
BD-365	31	DO-267	28	ES-188	38	FG-195	21	OM-196	18
BD-366	31	DO-268	27	ES-189	38			OM-197	18
BD-367	31	DO-269	27	ES-190	38	FL-129	44	OM-198	18
BD-370	33	DO-275	26	ES-191	39	FL-137	29	OM-230	8
BD-371	33	DO-276	26	ES-192	39	FL-413	24	OM-231	8
BD-372	33	DO-277	26	ES-211	7	FL-414	24	OM-240	19
BD-373	33	DO-278	26	ES-212	7	FL-415	24	OM-241	19
BD-374	34	DO-297	26	ES-213	7	FL-416	24	OM-242	19
BD-375	34	DO-298	26	ES-215	7			OM-243	19
BD-376	34	DO-300	28	ES-216	7	FM-302	22		
BD-377	34	DO-316	29	ES-217	7	FM-304	46	PH-37	41
BD-380	35	DO-320	27	ES-219	10	FM-308	22		
BD-381	35	DO-321	27	ES-221	11	FM-313G	49	RE-01	3, 15
BD-382	35	DO-322	27	ES-301	56	FM-314G	49	RE-02	3, 15
		DO-401	15	ES-302	56	FM-318	46	RE-03	3, 15
BF-64	61	DO-401R	15	ES-303	56	FM-319	46	RE-10	3, 15
				ES-306	56	FM-332	47		
BT-21	11	ES-02	29	ES-311	57	FM-332G	48	SC-3	23
BT-53	14	ES-03	56	ES-312	57	FM-333	47		
BT-58	14	ES-04	29	ES-313	57	FM-333G	48		
BT-59	14	ES-05M	36	ES-314	57				
BT-138	11	ES-05S	36	ES-315	57	FO-95	23		
BT-149	14	ES-18S	13	ES-316	57	FO-190	23		
BT-150	14	ES-19S	13	ES-317	58	FO-235	44		
BT-362	14	ES-20S	13	ES-318	58	FO-350	20		
BT-363	14	ES-20	13	ES-319	58	FO-370	20		
BT-364	14	ES-29	29	ES-320	58	FO-371	20		
BT-365	14	ES-43	36	ES-321	58	FO-372	20		
BT-370	14	ES-86	39	ES-322	58	FO-390	20		
BT-501	3	ES-110	11	ES-323	58	FO-391	20		
BT-502	3	ES-130	55	ES-331	59	FO-392	20		
BT-503	3	ES-131	5	ES-339	59	FO-397	20		
BT-504	3	ES-132	5	ES-340	59				
BT-505	4	ES-133	5	ES-341	59	FR-34	24		
BT-510	4	ES-134	5	ES-342	59	FR-190	11		
BT-511	5	ES-135	5	ES-343	59				
		ES-136	6	ES-344	60	GF-79	41		
DB-118	10	ES-137	6	ES-345	60	GF-182	45		
DB-119	10	ES-138	6	ES-346	60	GF-183	45		
		ES-139	6	ES-347	60	GF-185	45		
DE-10	42	ES-144	10	ES-348	60	GF-186	45		
DE-11	42	ES-145	55	ES-349	60	GF-238	41		
DE-12	42	ES-145M	55	ES-350	60	GF-239	41		
DE-13	42	ES-146	12	ES-351	60				
DE-14	42	ES-147	12	ES-352	60	HT-131K	54		
DE-15	43	ES-148	12	ES-353	60	HT-134K	54		
DE-16	43	ES-149	10	ES-354	60	HT-180X	54		
DE-17	43	ES-150	51	ES-355	60	HT-250S	54		
DE-18	43	ES-151	51	ES-356	60	HT-300X	54		
		ES-152	51	ES-357	60	HT-1331K	54		
DO-113	25	ES-153	51	ES-358	60	HT-1332K	54		
DO-114	25	ES-154	51	ES-359	60				



Service und Reparatur  
Service and Repair  
Servizio e Riparazione  
Servicio y Reparación  
Service et Réparation

Service und Reparatur

Sadiq Surgical Co. bietet eine Full-Service-Wartung und Reparatur für alle chirurgischen Instrumente:

- Schärfen, Schleifen, Richten und Polieren
- Hartmetalleinsatz erneuern (TC) Personalisieren der
- Instrumente durch Signierung Reparaturen

Service and Repair

Sadiq Surgical Co. offers a full service maintenance and repair in all surgical instruments:

- Sharpening, Alignment and Polishing Tungsten-
- Carbide Inserts Replacement (TC) Personalized
- Etching
- Repairs

Servizio e Riparazione

Sadiq Surgical Co. offre un servizio completo di manutenzione e riparazione di tutti gli strumenti chirurgici :

- Affilatura, Allineamento e Lucidatura Sostituzione
- inserti in carburo di tungsteno (TC) Incisione
- personalizzata
- Riparazione

Servicio y Reparación

Sadiq Surgical co. ofrece un servicio completo de mantenimiento

y reparación para todos los instrumentos quirúrgicos:

- Afilado, Alineación y Pulido
- Reemplazo de plaquetas en carburo de tungsteno (TC)
- Grabado personalizado

Service et Réparation

Sadiq Surgical Co. offre un complet service de maintenance et de réparation pour tous les instruments chirurgicaux:

- Aiguillage, Alignement et Polissage
- Remplacement de plaquettes en carbure de tungstène (TC) Gravure personnalisée



Vergleichstabellen  
Conversion Tables  
Tabelle di comparazione  
Tablas de comparación  
Tableaux de comparaison

International System of Units - Imperial Units

SI	SI	Imperial
1 millimetre		0.0394 in
1 centimetre	10 mm	0.3937 in
1 metre	1000 mm	1.0936 yd
Imperial	Imperial	SI
1 inch		2.540 cm
1 foot	12 in	30.48 cm
1 yard	3 ft	91.440 cm

1 Inch is equal to

Unit
0.254 m
2.540 cm
25.40 mm
100 points
1,000 thou (mil)
1,000,000 $\mu$ in (micro inch)
0.02778 yards

Fractional and Decimal Inches - Millimetres

Fractional	Decimal	Mm
1/64	0.0156	0.3969
1/32	0.0313	0.7938
1/16	0.0625	1.5875
1/8	0.1250	3.1750
3/16	0.1875	4.7625
1/4	0.2500	6.3500
5/16	0.3125	7.9375
3/8	0.3750	9.5250
7/16	0.4375	11.1125
1/2	0.5000	12.7000
9/16	0.5625	14.2875
5/8	0.6250	15.8750
11/16	0.6875	17.4625
3/4	0.7500	19.0500
13/16	0.8125	20.6375
7/8	0.8750	22.2250
15/16	0.9375	23.8125
1	1.0000	25.4000

Inches - Millimetres

In	Mm
0.001	0.0254
0.002	0.0508
0.003	0.0762
0.004	0.1016
0.005	0.1270
0.006	0.1524
0.007	0.1778
0.008	0.2032
0.009	0.2286
0.010	0.2540
0.011	0.2794
0.012	0.3048
0.013	0.3302
0.014	0.3556
0.015	0.3810
0.016	0.4064
0.017	0.4318
0.018	0.4572
0.019	0.4826
0.020	0.5080
0.021	0.5334
0.022	0.5588
0.023	0.5842
0.024	0.6096
0.025	0.6350
0.026	0.6604
0.027	0.6858
0.028	0.7112
0.029	0.7366
0.030	0.7620
0.031	0.7874
0.032	0.8128
0.033	0.8382
0.034	0.8636
0.035	0.8890
0.036	0.9144
0.037	0.9398
0.038	0.9652
0.039	0.9906
0.0394	1.0000

Celsius - Fahrenheit

°C	°F	In	Cm
0	32	1	2.54
10	50	2	5.08
20	68	3	7.62
30	86	4	10.16
40	104	5	12.7
50	122	6	15.24
60	140	7	17.78
70	158	8	20.32
80	176	9	22.86
90	194	10	25.40
100	212	11	27.94
110	230	12	30.48
120	248	13	33.02
130	266	14	35.56
140	284	15	38.10
150	302	16	40.64
200	392	17	43.18

Service & Réparation

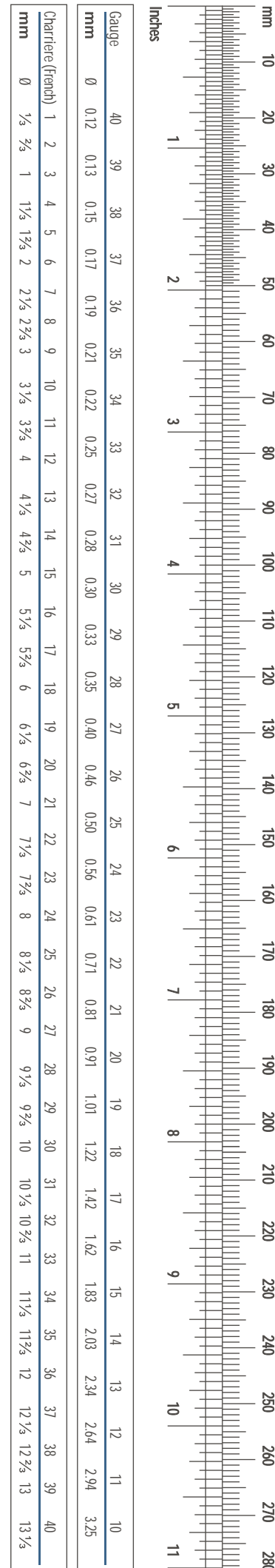



**Company Name: Sadiq Surgical**

**Address: Ugoki Road, New Adalat Garah, Street Number: 01**

**Bhutta Chock, Sialkot 51310 PK**

**Mobile Phone: 0092 346 6629614**

**Mobile Phone: 0092 301 3075058**

**Email: [info@sadiqsurgical.com](mailto:info@sadiqsurgical.com)**

**Email: [sadiqsurgical@gmail.com](mailto:sadiqsurgical@gmail.com)**

**Website: [www.sadiqsurgical.com](http://www.sadiqsurgical.com)**



**SADIQ SURGICAL CO.**

Catalogue 2015 / 2016



**Plastic Surgery**